



## OPERATING MANUAL

### K II S Series Induction Motor



## Introduction

### ■ Before using the motor

Only qualified personnel should work with the product. Use the product correctly after thoroughly reading the section "Safety precautions." In addition, be sure to observe the contents described in warning, caution, and note in this manual. The product described in this manual has been designed and manufactured to be incorporated in general industrial equipment. Do not use for any other purpose. Oriental Motor Co., Ltd. is not responsible for any damage caused through failure to observe this warning.

## Safety precautions

The precautions described below are intended to prevent danger or injury to the user and other personnel through safe, correct use of the product. Use the product only after carefully reading and fully understanding these instructions.

<b>⚠ WARNING</b>	Handling the product without observing the instructions that accompany a "WARNING" symbol may result in serious injury or death.
<b>⚠ CAUTION</b>	Handling the product without observing the instructions that accompany a "CAUTION" symbol may result in injury or property damage.
<b>Note</b>	The items under this heading contain important handling instructions that the user should observe to ensure safe use of the product.

## ⚠ WARNING

- Do not use the product in explosive or corrosive environments, in the presence of flammable gases, or near combustibles. Doing so may result in fire, electric shock or injury.
- Only qualified and educated personnel should be allowed to perform installation, connection, operation and inspection/troubleshooting of the product. Handling by unqualified and uneducated personnel may result in fire, electric shock, injury or equipment damage.
- Do not transport, install the product, perform connections or inspections when the power is on. Always turn the power off before carrying out these operations. Failure to do so may result in electric shock.
- The motor is Class I equipment. Install the motor so as to avoid contact with hands, or ground it to prevent the risk of electric shock.
- Keep the input power voltage within the specified range. Failure to do so may result in fire or electric shock.
- Securely connect the cables in accordance with the connection examples. Failure to do so may result in fire or electric shock.
- Do not forcibly bend, pull or pinch the cable or lead wire. Doing so may result in fire and electric shock.
- Turn off the power in the event of a power failure. Or the motor may suddenly start when the power is restored and may cause injury or damage to equipment.
- Do not disassemble or modify the motor. This may cause electric shock or injury.

## ⚠ CAUTION

- Do not use the motor beyond its specifications. Doing so may result in electric shock, injury or damage to equipment.
- Do not touch the motor during operation or immediately after stopping. The surface is hot and may cause a skin burn(s).
- Do not lift the motor by holding the motor output shaft or motor cable or lead wire. Doing so may result in injury.
- Keep the area around the motor free of combustible materials. Failure to do so may result in fire or a skin burn(s).
- Do not leave anything around the motor that would obstruct ventilation. Doing so may result in damage to equipment.
- The motor does not have a built-in overheat protection device. Provide a protection device externally.
- Do not touch the rotating part (output shaft) while operating the motor. Doing so may result in injury.
- When an abnormality is noted, turn off the power immediately. Failure to do so may result in fire, electrical shock or injury.
- The motor surface temperature may exceed 70 °C (158 °F) even under normal operating conditions. If the operator is allowed to approach the running motor, attach a warning label as shown in the figure in a conspicuous position. Failure to do so may result in a skin burn(s).
- Dispose the product correctly in accordance with laws and regulations, or instructions of local governments.



Warning label

Thank you for purchasing an Oriental Motor product. This Operating Manual describes product handling procedures and safety precautions.

- Please read it thoroughly to ensure safe operation.
- Always keep the manual where it is readily available.

## Preparation

### ■ Checking the product

Verify that the items listed below are included. Report any missing or damaged items to the branch or sales office from which you purchased the product.

- Motor..... 1 unit  
The combination type comes with the motor and its dedicated gearhead pre-assembled.
- Mounting screw set..... 1 set (only for combination type)  
Hexagonal socket head screw, washer, spring washer 4 pieces each
- Parallel key..... 1 piece (only for combination type)  
The parallel key is included with the product or fixed to the gearhead output shaft.
- OPERATING MANUAL..... 1 copy (this document)

### ■ Checking the model name

Check the model names of the motor and the gearhead against the model name described on each nameplate. A decimal gearhead is attached depending on the gear ratio.

Tell us the model name, product serial number, and manufacturing date when you contact us.

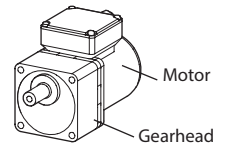

### ● Combination type

- Terminal box type (Degree of protection: IP66)  
Output shaft material: Stainless steel

Combination type		Motor model	Gearhead		Decimal gearhead model
Model	Gear ratio		Model	Gear ratio	
4IK30V■3T2-□S	5 to 360	4IK30VGV-■3T2	4GV□BS	5 to 360	4GV10X
	500 to 3600*			50 to 360	
5IK40V■3T2-□S	5 to 300	5IK40VGV-■3T2	5GV□BS	5 to 300	5GV10X
	360 to 3000*			36 to 300	
5IK60V■3T2-□S	5 to 300	5IK60VGVH-■3T2	5GVH□BS	5 to 300	-
5IK100V■3T2-□S	5 to 180	5IK100VGV-■3T2	5GVR□BS	5 to 180	-
7IK200V■3T2-□S	5 to 100	7IK200VGV-■3T2	7GV□BS	5 to 100	-

- : Enter a motor classification representing the power supply voltage.  
JS: Three-phase 200 V 50/60 Hz ES: Three-phase 220/230 V 50/60 Hz  
EU: Three-phase 380/400/415 V 50/60 Hz (7IK200 only)
- : Enter a number representing the gear ratio.
- \* A gear ratio of the combination type attached a decimal gearhead is ten times as the gear ratio of the gearhead.

Output shaft material: Iron

Combination type	Motor model	Gearhead	
		Model	Gear ratio
5IK60V■T2-□	5IK60VGVH-■T2	5GVH□B	5 to 300
5IK100V■T2-□	5IK100VGV-■T2	5GVR□B	5 to 180

- : Enter a motor classification representing the power supply voltage.  
JS: Three-phase 200 V 50/60 Hz ES: Three-phase 220/230 V 50/60 Hz
- : Enter a number representing the gear ratio.

### ● Lead wire type (Degree of protection: IP20)

Output shaft material: Iron

Combination type	Motor model	Gearhead	
		Model	Gear ratio
5IK60V■-□	5IK60VGVH-■	5GVH□B	5 to 300
5IK100V■-□	5IK100VGV-■	5GVR□B	5 to 180

- : Enter a motor classification representing the power supply voltage.  
JS: Three-phase 200 V 50/60 Hz ES: Three-phase 220/230 V 50/60 Hz
- : Enter a number representing the gear ratio.

### ● Round shaft type

For the model name of the round shaft type, "AS" or "A" is used instead of "GV", "GVH" or "GVR" in the "motor model name," which indicates the motor shaft type. (For the degree of protection for the round shaft type, the motor mounting surface is excluded.)

## Installation

### Location for installation

Install it in a well-ventilated location that provides easy access for inspection.

[ Common conditions ]

- Operating ambient temperature -10 to +40 °C (+14 to +104 °F) (non-freezing)
- Operating ambient humidity 85%, maximum (non-condensing)
- Area that is free from an explosive atmosphere or toxic gas (such as sulfuric gas) or liquid
- Area not exposed to direct sun
- Area free of excessive amount dust, iron particles or the like
- Area free of excessive salt
- Area not subject to continuous vibration or excessive shocks
- Area free of excessive electromagnetic noise (from welders, power machinery, etc.)
- Area free of radioactive materials, magnetic fields or vacuum
- Altitude Up to 1000 m (3300 ft.) above sea level

[ Terminal box type ]

- Indoors
  - Not exposed to oil (oil droplets) or chemicals
  - The motor can be used in an environment that is splashed with water (excluding the mounting surface of the round shaft type).
- Not available for use under high pressure jets of water or immersion in water.

[ Lead wire type ]

- Inside an enclosure that is installed indoors (provide vent holes)
- Area not subject to splashing water (storms, water droplets), oil (oil droplets) or other liquids

**Note** On rare occasions, grease may ooze out from the gearhead. If there is a concern over possible environmental damage resulting from the leakage of grease, provide an oil tray or similar oil catching mechanism in order not to cause a secondary damage. Grease leakage may lead to problems in the customer's equipment or products.

### Installation method

**Note** Do not install the motor to the mounting hole diagonally or assemble the motor forcibly. Doing so may cause damage to the motor.

#### Combination type

Secure the motor with mounting screw set (supplied) through the four mounting holes provided. Do not leave a gap between the motor and mounting plate.

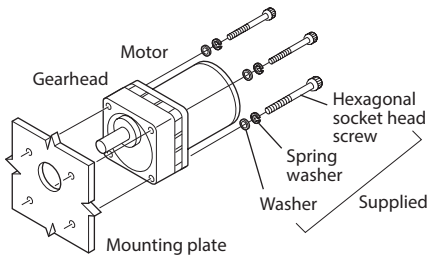

Mounting screw set (supplied)

Material: Stainless steel

Model	Gear ratio	Hexagonal socket head screws		L2 [mm (in.)]	Tightening torque [N·m (lb-in)]
		Screw size	L1 [mm (in.)]		
4IK30	①	5 to 25	60 (2.36)	9 (0.35)	5.0 (44)
		30 to 120	65 (2.56)	9 (0.35)	
		150 to 360	70 (2.76)	9 (0.35)	
	②	500 to 1200	110 (4.33)	15 (0.59)	
		1500 to 3600		10 (0.39)	
5IK40	①	5 to 18	70 (2.76)	14 (0.55)	12.0 (106)
		25 to 100	85 (3.35)	16 (0.63)	
		120 to 300	90 (3.54)	15 (0.59)	
	②	360 to 1000	130 (5.12)	18 (0.71)	
		1200 to 3000		12 (0.47)	
5IK60	①	5 to 18	70 (2.76)	14 (0.55)	12.0 (106)
		25 to 100	85 (3.35)	16 (0.63)	
		120 to 300	90 (3.54)	15 (0.59)	
5IK100	①	5 to 15	70 (2.76)	14 (0.55)	12.0 (106)
		18 to 36	85 (3.35)	16 (0.63)	
		50 to 180	95 (3.74)	14 (0.55)	
7IK200	①	5 to 20	85 (3.35)	11 (0.43)	12.0 (106)
		30, 50	100 (3.94)	14 (0.55)	
		100	110 (4.33)	10 (0.39)	

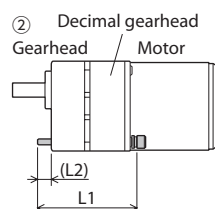
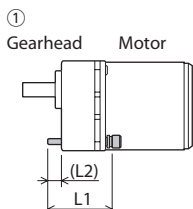

### Removing and assembling the gearhead and the decimal gearhead

See the following steps to replace the gearhead or to change the position of the terminal box and the outlet position of the lead wires.

#### Removing the gearhead from the motor

Remove the hexagonal socket head screws (2 places) assembling the motor, gearhead and decimal gearhead, and detach the gearhead and decimal gearhead from the motor.

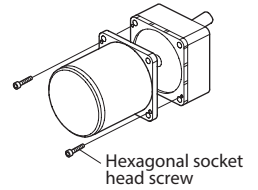

#### Assembling the gearhead to the motor

1. Keep the pilot sections of the motor and gearhead in parallel, and assemble the gearhead with the motor while slowly rotating it clockwise/ counterclockwise. At this time, note so that the pinion of the motor output shaft does not hit the side panel or gears of the gearhead strongly.
2. Check no gaps remain between the motor and gearhead, and tighten them with hexagonal socket head screws (2 pieces).  
When using a decimal gearhead, install it between the motor and the gearhead.

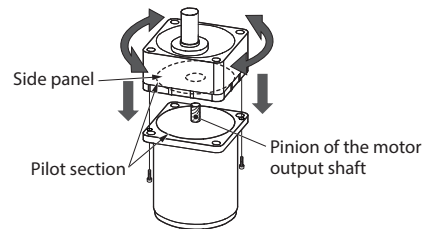

Assemble the gearhead to the motor in a condition where the motor output shaft is in an upward direction.

Gearhead model	Screw size	Tightening torque [N·m (lb-in)]
4GV	M2.6	0.4 (3.5)
5GV, 5GVH, 5GVR, 7GV	M3	0.6 (5.3)

**Note**

- Do not forcibly assemble the motor and gearhead. Also, prevent metal objects or foreign substances from entering in the gearhead. The pinion of the motor output shaft or gear may be damaged, resulting in noise or shorter service life.
- O-rings are attached on the motor flange and the mounting surface of the decimal gearhead. Install the gearhead so as not to pinch the O-rings. Grease in the gearhead may leak.

#### Round shaft type

Secure the motor with hexagonal socket head screws (not supplied) through the four mounting holes provided. Do not leave a gap between the motor and mounting plate.

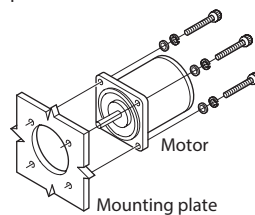

Model	Screw size	Tightening torque [N·m (lb-in)]
4IK	M5	3.0 (26)
5IK	M6	5.0 (44)[6.4 (56)] *
7IK	M8	12.0 (106)

\* Material of hexagonal socket head screw: Stainless steel [Iron]

#### Installing a load

The gearhead shaft is provided with a key slot for connecting the transmission parts. When connecting the transmission parts, ensure that the shaft and parts have a clearance fit, and always fix the parallel key to the output shaft with a screw to prevent the parts from rattling or spinning.

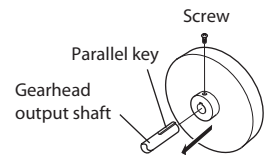

**Note** Do not apply excessive force onto the output shaft of the gearhead using a hammer or other tools. Doing so may cause damage to the output shaft or bearings.

#### When using the output shaft end tapped hole of a gearhead

Use a tapped hole provided at the end of the output shaft as an auxiliary means for preventing the transfer mechanism from disengaging.

Gearhead model	Output shaft end tapped hole
4GV	M5, Effective depth 10 mm (0.39 in.)
5GV, 5GVH, 5GVR, 7GV	M6, Effective depth 12 mm (0.47 in.)

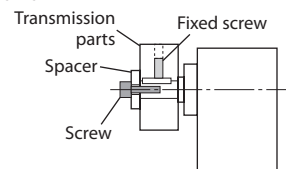

## Connection

Insulate the connecting part of the motor lead wires and power supply.

### ■ Connecting Protective Earth Terminal

Be sure to ground the motor using the Protective Earth Terminal (⊕) on the motor.

**Note** Be sure to use the screw for grounding attached on the product.

Use a crimp terminal described below for grounding.

Applicable crimp terminal:  
Insulated round crimp terminal  
Terminal screw size: M4  
Tightening torque: 1.0 to 1.5 N·m  
(8.8 to 13.2 lb-in)

Applicable lead wire size:  
AWG18 (0.75mm<sup>2</sup>) or thicker

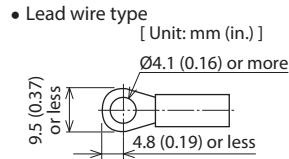

\* For the terminal box type, use the same crimp terminal used to connect the cable to the terminal block.

### ■ Wiring diagram

#### ⚠ CAUTION

The motor does not have a built-in overheat protection device. When the output shaft is locked or in the case of an overload state, use an electromagnetic switch in order to prevent the motor from burning out. (Refer to p.4 for details)

The rotation direction of the combination type varies depending on the gear ratio of the gearhead. Check the motor model name and the gear ratio before connecting. The figure shows a connection diagram for when the motor is directly connected to a power supply.

When connecting as the connection diagram the motor rotates in the direction as shown below.

Gear ratio  and the round shaft type : CW (clockwise)

Gear ratio  : CCW (counter clockwise)

Model	Gear ratio										
	5	6	7.5	9	12.5	15	18	25	30	36	50
4IK30	60	75	90	100	120	150	180	250	300	360	500
	600	750	900	1000	1200	1500	1800	2500	3000	3600	-
5IK40	60	75	90	100	120	150	180	250	300	360	500
	600	750	900	1000	1200	1500	1800	2500	3000	-	-
5IK60	5	6	7.5	9	12.5	15	18	25	30	36	50
	60	75	90	100	120	150	180	250	300	-	-
5IK100	5	6	7.5	9	12.5	15	18	25	30	36	50
	60	75	90	100	120	150	180	-	-	-	-
7IK200	5	10	15	20	30	50	100	-	-	-	-

To change the direction of rotation, change any two connections between R, S and T.

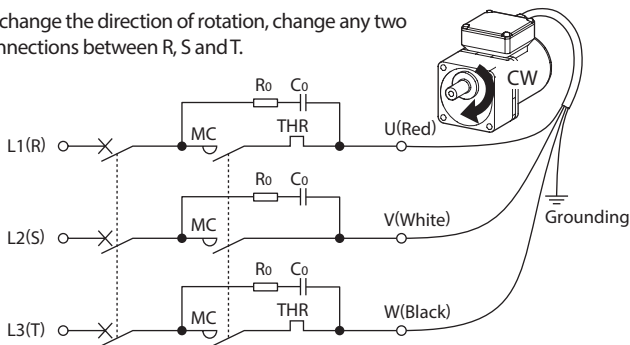

Codes U, V, and W shown in the connection diagram indicate terminal codes inside the terminal box for the terminal box type. Colors in parentheses ( ) indicate those of lead wires for the lead wire type.

#### [ Electromagnetic switch ]

MC: Electromagnetic contactor  
THR: Thermal relay

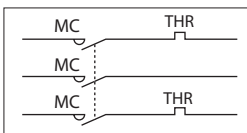

#### [ Surge voltage measures ]

In order to protect contacts, connect a CR circuit for surge suppression as shown in the figure.

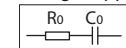

- Motor rated voltage 200 to 240 VAC  
R<sub>0</sub>=5 to 200 Ω  
C<sub>0</sub>=0.1 to 0.2 μF 250 VAC  
It is provided as an accessory (sold separately).  
Model: **EPCR1 201-2**
- Motor rated voltage 380 to 415 VAC  
R<sub>0</sub>=5 to 200 Ω  
C<sub>0</sub>=0.1 to 0.2 μF 450 VAC

## ■ Connection method to a terminal block

Remove the terminal box cover for the terminal box type, and connect a cable. Cables for connection are available as accessories (sold separately).

- If the O-ring that has set in the matching surface of the terminal box cover falls off, install it securely in the groove portion of the terminal box cover.
- After connecting the cable, securely tighten with the tightening torque in the table below.

#### Note

- To make shielding function fully effective, use a cable of an appropriate diameter and observe the specified tightening torque of screws.
- Secure the cable drawn from the motor terminal box so that it does not receive stress.
- Check periodically if any of the mounting screws is loose.

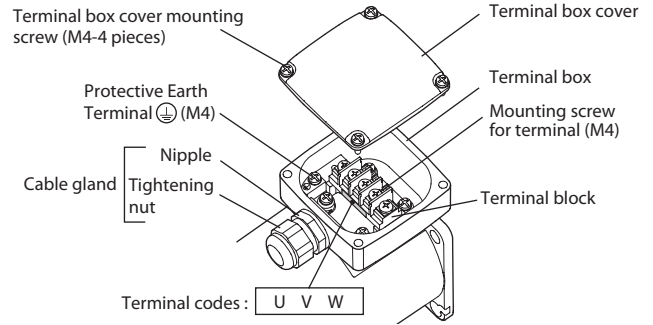

Tightening torque [Unit: N·m (lb-in)]

Terminal box cover mounting screw	1.0 to 1.5 (8.8 to 13.2)
Mounting screw for terminal	1.0 to 1.2 (8.8 to 10.6)
Tightening nut	2.0 to 2.5 (17.7 to 22)
Nipple	2.0 to 2.5 (17.7 to 22)

- When connecting the cable on the terminal block, use the following cable and crimp terminal.

Applicable crimp terminal:  
Insulated round crimp terminal  
Applicable cable diameter:  
Ø7 to Ø13 mm (Ø0.28 to Ø0.51 in.) \*  
Applicable lead wire: AWG18 (0.75 mm<sup>2</sup>) or thicker  
\* Round shaft type: Ø8 to Ø13 mm (Ø0.31 to Ø0.51 in.)

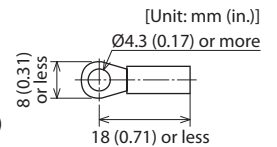

### ● Changing the cable outlet position

The cable outlet position can be changed to the left or right 90-degree direction, or the 180-degree direction.

When changing the direction of the cable outlet position, loosen the terminal box mounting screws, and rotate the terminal box to change the mounting direction.

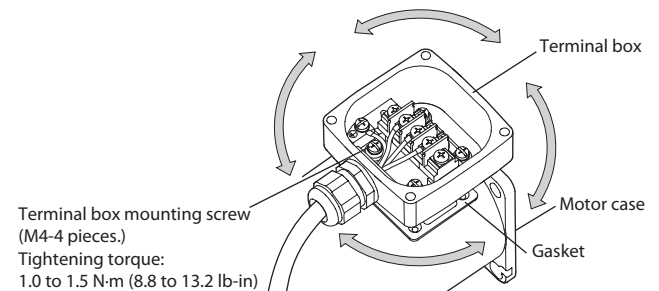

#### Note

- Be sure to use the gasket which has been put in the product at the time of shipment.
- Assemble not to enter any foreign object between the terminal box and motor case.

## Operation

The motor rotates when the power supply is turned on. For protection against electric shock, do not turn on the power supply until the wiring is complete.

#### Note

- Make sure that the motor case temperature does not exceed 90 °C (194 °F) when operating the motor. Operation exceeding case temperature 90 °C (194 °F) may significantly deteriorate the coils and ball bearings of the motor and shorten the motor's life span. Motor case temperature can be measured by fixing a thermometer on the motor surface. It can also be measured using thermo tape or a thermocouple.
- Do not perform an operation switching the motor rotation direction instantaneously. Doing so may cause damage to the motor and gearhead.
- Care should be taken when using in a low-temperature environment as the transmission efficiency will drop along with the output torque.

## Burnout protection for overload/locked-rotor state

### ■ When connecting to the power supply

- Always connect an electromagnetic switch.  
Connect the electromagnetic switch according to the operating manual of the electromagnetic switch.
- Set the motor rated current for the thermal relay.  
The motor rated current is described on the motor nameplate.
- For electromagnetic switches, use the products as shown in the chart, or an equivalent.

[ Fuji Electric FA Components & Systems Co., Ltd. ]

Motor output power	Part number
30 W, 40 W	SC11AAN-□10TD
60 W	SC11AAN-□10TF
100 W	SC11AAN-□10TH
200 W, rated voltage 200 to 240 VAC	SC11AAN-□10TK
200 W, rated voltage 380 to 415 VAC	SC11AAN-□10TH

- Enter the coil code in the box (□) within the part number.  
Use the product which satisfies the motor rated voltage by selecting the coil code.

Rated voltage		Coil code
50 Hz	60 Hz	
200 V	200-220 V	2
200-220 V	220-240 V	M
220-240 V	240-260 V	P
346-380 V	380-420 V	S
380-400 V	400-440 V	4
415-440 V	440-480 V	T

[ Mitsubishi Electric Corporation ]

Motor output power	Part number
30 W, 40 W	MSO-T10 0.24A 200V AC200V
60 W	MSO-T10 0.35A 200V AC200V
100 W	MSO-T10 0.5A 200V AC200V
200 W, rated voltage 200 to 240 VAC	MSO-T10 0.9A 200V AC200V
200 W, rated voltage 380 to 415 VAC	MSO-T10 0.5A 400V AC400V

### ■ When connecting to the inverter

Be sure to set the electronic thermal relay according to the operating manual of the inverter. Unless the electronic thermal relay is set, a burnout may result.

## When using the motor with an inverter

When the motor is used with connecting an inverter, perform the following settings to the inverter. When driving the inverter, use it at the setting frequency 120 Hz or lower.

### ■ Setting for motor

Electronic thermal relay function	Set the rated current listed on the motor nameplate based on the base frequency and the voltage applied to the motor.
Applicable motor setting	Constant-torque motor or inverter motor
Motor capacity	Motor rated output power If the setting value in the inverter does not exist, set the closest value.
Number of motor poles	4 poles

### ■ Notes about when using the motor with an inverter

The inverter which input voltage exceeds 240 VAC cannot be used. The 71K200VEU exceeds 415 VAC cannot be used. The insulation of the motor winding may deteriorate, causing damage to the motor.

## Time rating

Continuous operation is possible (continuous rating)

## Troubleshooting

When the motor cannot be operated correctly, refer to the contents provided in this section and take appropriate action. If the problem persists, contact your nearest office.

Phenomena	Check items
Motor does not rotate.	<ul style="list-style-type: none"> <li>Check the power supply voltage.</li> <li>Connect the power supply and the motor correctly.</li> </ul>
Motor sometimes rotates and stops.	<ul style="list-style-type: none"> <li>If terminal blocks or crimp terminals are used, check them for poor connection.</li> <li>Keep the load at or below the allowable value.</li> </ul>
The motor rotates in the direction opposite to the specified direction.	<ul style="list-style-type: none"> <li>The connection varies depending on the gear ratio of the gearhead.</li> <li>The rotation direction is as viewed from the output shaft end. Check the reference direction.</li> </ul>
Motor temperature abnormally high [Motor case temperature exceeds 90 °C (194 °F) ]	<ul style="list-style-type: none"> <li>Check the power supply voltage.</li> <li>Review the ventilation condition.</li> </ul>

Phenomena	Check items
Noisy operation	<ul style="list-style-type: none"> <li>Assemble the motor and gearhead correctly.</li> <li>Assemble a gearhead of the same pinion type as the motor.</li> </ul>

## Regulations and standards

### ■ UL Standards, CSA Standards

This product is recognized by UL under UL and CSA Standards. The motor model name represents the model that conforms to the standards.

Applications standards	Certification Body / File No.
UL 1004-1, CSA C22.2 No.100	UL / E62327

- Thermal Class: 130 (B)

### ■ CCC System

This product is affixed the CCC Mark under the China Compulsory Certification System. It is also certified by CQC.

Applications standards: GB/T 12350

### ■ CE Marking

This product is affixed the CE Marking under the Low Voltage Directive.

### ● Low Voltage Directive

- Applications standards

EN 60034-1, EN 60034-5, EN 60664-1

- Installation conditions (For EN standard)

Terminal box type: Overvoltage category II, Pollution degree 3, Class I equipment  
Lead wire type: Overvoltage category II, Pollution degree 2, Class I equipment  
When the machinery to which the motor is mounted requires overvoltage category III specifications, install the motor in a cabinet that connect to power supply via an isolation transformer.

- Motor temperature rise tests

Temperature rise tests required by the above standards are performed in a state that has been attached a heat radiation plate instead of a gearhead. The size and material for the heat radiation plates are as follows.

Model	Size [mm (in.)]	Thickness [mm (in.)]	Material
41K30	135×135 (5.31×5.31)	5 (0.20)	Aluminum alloy
51K40	165×165 (6.50×6.50)		
51K60 51K100	200×200 (7.87×7.87)		
71K200	250×250 (9.84×9.84)	6 (0.24)	

### ■ RoHS Directive

The products do not contain the substances exceeding the restriction values of RoHS Directive (2011/65/EU).

### ■ Electrical Appliance and Material Safety Law

200/220/230/240 VAC types : The terminal box round shaft motor type bears a  mark.

- Unauthorized reproduction or copying of all or part of this manual is prohibited.
- Oriental Motor shall not be liable whatsoever for any problems relating to industrial property rights arising from use of any information, circuit, equipment or device provided or referenced in this manual.
- Characteristics, specifications and dimensions are subject to change without notice.
- While we make every effort to offer accurate information in the manual, we welcome your input. Should you find unclear descriptions, errors or omissions, please contact the nearest office.
- Oriental Motor** is a registered trademark or trademark of Oriental Motor Co., Ltd., in Japan and other countries.

© Copyright ORIENTAL MOTOR CO., LTD. 2015

Published in June 2020

- Please contact your nearest Oriental Motor office for further information.

ORIENTAL MOTOR U.S.A. CORP.  
Technical Support Tel:(800)468-3982  
8:30 A.M. to 5:00 P.M., P.S.T. (M-F)  
7:30 A.M. to 5:00 P.M., C.S.T. (M-F)  
www.orientalmotor.com

ORIENTAL MOTOR DO BRASIL LTDA.  
Tel:+55-11-3266-6018  
www.orientalmotor.com.br

ORIENTAL MOTOR (EUROPA) GmbH  
Schiesstraße 44, 40549 Düsseldorf, Germany  
Technical Support Tel:00 800/22 55 66 22  
www.orientalmotor.de

ORIENTAL MOTOR (UK) LTD.  
Tel:01256-347090  
www.oriental-motor.co.uk

ORIENTAL MOTOR (FRANCE) SARL  
Tel:01 47 86 97 50  
www.orientalmotor.fr

ORIENTAL MOTOR ITALIA s.r.l.  
Tel:02-93906346  
www.orientalmotor.it

ORIENTAL MOTOR CO., LTD.  
4-8-1 Higashiueno, Taito-ku, Tokyo 110-8536  
Japan  
Tel:03-6744-0361  
www.orientalmotor.co.jp

ORIENTAL MOTOR ASIA PACIFIC PTE. LTD.  
Singapore  
Tel:1800-8420280  
www.orientalmotor.com.sg

ORIENTAL MOTOR (MALAYSIA) SDN. BHD.  
Tel:1800-806161  
www.orientalmotor.com.my

ORIENTAL MOTOR (THAILAND) CO., LTD.  
Tel:1800-888-881  
www.orientalmotor.co.th

ORIENTAL MOTOR (INDIA) PVT. LTD.  
Tel:+91-80-41125586  
www.orientalmotor.co.in

TAIWAN ORIENTAL MOTOR CO., LTD.  
Tel:0800-060708  
www.orientalmotor.com.tw

SHANGHAI ORIENTAL MOTOR CO., LTD.  
Tel:400-820-6516  
www.orientalmotor.com.cn

INA ORIENTAL MOTOR CO., LTD.  
Korea  
Tel:080-777-2042  
www.inaom.co.kr

ORIENTAL MOTOR CO., LTD.  
Hong Kong Branch  
Tel:+852-2427-9800