



Brushless Motor

BLH Series Digital Setting Type

OPERATING MANUAL



Thank you for purchasing an Oriental Motor product.

This Operating Manual describes product handling procedures and safety precautions.

- Please read it thoroughly to ensure safe operation.
- Always keep the manual where it is readily available.

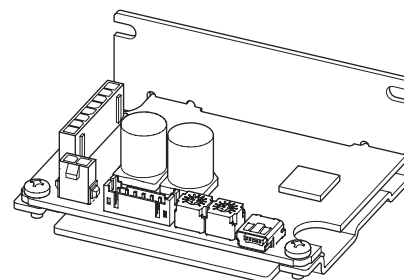

Table of contents

1	Introduction	3	9	Settings of MEXE02	53
2	Safety precautions	4	9.1	Timing to update data when the setting is changed	53
3	Precautions for use	5	9.2	Parameter list.....	54
4	Preparation	6	9.3	Operation data extension setting	57
4.1	Checking the product	6	9.4	Operation and I/O action	60
4.2	How to identify the product model	6	9.5	Alarm and information settings.....	64
4.3	Information about nameplate.....	6	9.6	Monitor setting	65
4.4	Products possible to combine.....	7	9.7	I/O function selection.....	66
4.5	Names and functions of parts	8	9.8	I/F function	67
5	Installation	9	10	Maintenance and inspection	68
5.1	Installation location.....	9	10.1	Inspection.....	68
5.2	Installing the driver	9	10.2	Warranty.....	68
6	Connection	10	10.3	Disposal	68
6.1	Connecting the motor and driver (CN3).....	10	11	Troubleshooting	69
6.2	Connecting the power supply (CN1)	11	12	Alarms	71
6.3	Connecting the I/O signals (CN2).....	12	12.1	Alarm reset	71
6.4	Driver I/O circuit	13	12.2	Alarm history	71
6.5	Connecting external analog setting devices	15	12.3	Alarm lists.....	72
6.6	Grounding	15	13	Information.....	73
6.7	Connecting the USB cable (CN4).....	16	13.1	Information history	73
6.8	Connection diagram	16	13.2	Information lists.....	74
6.9	Noise measures.....	17	14	Specifications.....	76
6.10	Conformity to the EMC Directive	18	14.1	Specifications	76
6.11	I/O signals	20	14.2	General specifications	77
7	Operation	28	14.3	Dimension	77
7.1	Guidance	28	15	Regulations and standards	78
7.2	Setting the operation data	28	15.1	UL Standards and CSA Standards	78
7.3	Setting the rotation speed.....	30	15.2	EU Directives.....	78
7.4	Setting the acceleration time and deceleration time	32	15.3	Republic of Korea, Radio Waves Act.....	78
7.5	Setting the torque limiting value	33	15.4	RoHS Directive	78
7.6	Operation and stop	35			
7.7	Rotation direction of the motor output shaft	36			
7.8	Multi-speed operation	36			
7.9	Multi-motor control	37			
8	How to use MEXE02	38			
8.1	Starting MEXE02	38			
8.2	Setting the operation data	39			
8.3	Setting the parameters	40			
8.4	Monitor	41			
8.5	Test operation.....	50			

1 Introduction

■ Before using the product

Only qualified personnel of electrical and mechanical engineering should work with the product.

Use the product correctly after thoroughly reading the section "2 Safety precautions." In addition, be sure to observe the contents described in warning, caution, and note in this manual.

The product described in this manual has been designed and manufactured to be incorporated in general industrial equipment. Do not use for any other purpose. For the power supply, use a DC power supply with reinforced insulation on its primary and secondary sides. Oriental Motor Co., Ltd. is not responsible for any damage caused through failure to observe this warning.

■ Operating manuals for the product



Operating manuals for the **BLH** Series are listed below.

Operating manuals are not included with the product. Download from Oriental Motor Website Download Page or contact your nearest Oriental Motor sales office.

	Operating manual name	Operating manual number
Driver	BLH Series Digital Setting Type OPERATING MANUAL(this document)	HP-5074
Motor	BLHM Motor OPERATING MANUAL	HM-5238
	BLHM Electromagnetic Brake Motor	HM-5258
	DC Power Input Drivers BLM Motor Connector type OPERATING MANUAL	HM-5267

2 Safety precautions

The precautions described below are intended to ensure the safe and correct use of the product, and to prevent the user and other personnel from exposure to the risk of injury. Use the product only after carefully reading and fully understanding these instructions.

 WARNING	Handling the product without observing the instructions that accompany a "WARNING" symbol may result in serious injury or death.
 CAUTION	Handling the product without observing the instructions that accompany a "CAUTION" symbol may result in injury or property damage.
 Note	The items under this heading contain important handling instructions that the user should observe to ensure safe use of the product.



Explanation of graphic symbols





Indicates "prohibited" actions that must not be performed.



Indicates "compulsory" actions that must be performed.

 WARNING	
	<ul style="list-style-type: none"> Do not use the product in explosive or corrosive environments, in the presence of flammable gases, in places subjected to splashing water, or near combustibles. Doing so may result in fire or injury. Do not transport, install, connect or inspect the product while the power is supplied. Always turn off the power before carrying out these operations. Damage to equipment may result. Do not use a motor in vertical drive such as elevating equipment. When the driver protective function is activated, the motor will stop operating. The moving part may fall, leading to injury or damage to equipment. Do not touch the motor or driver when conducting the insulation resistance measurement or dielectric strength test. Accidental contact may result in electric shock. Do not disassemble or modify the driver. Doing so may cause injury or damage to equipment. Refer all such internal inspections and repairs to the branch or sales office from which you purchased the product.
	<ul style="list-style-type: none"> Only qualified and educated personnel should be allowed to perform installation, connection, operation and inspection/troubleshooting of the product. Handling by unqualified and uneducated personnel may result in fire, injury or damage to equipment. Use a motor and driver only in the specified combination. Failure to do so may result in fire or damage to equipment. If the driver protective function was activated, remove the cause before resetting the protective function. Continuing the operation without removing the cause of the problem may cause malfunction of the motor, leading to injury or damage to equipment. Install the driver in an enclosure. Failure to do so may result in injury. Always keep the power supply voltage of the driver within the specified range. Failure to do so may result in fire. Connect the cables securely according to the wiring example. Failure to do so may result in fire or damage to equipment. Be sure to observe the specified cable sizes. Failure to do so may result in fire or damage to equipment. For the driver power supply, use a DC power supply with reinforced insulation on its primary and secondary sides. Failure to do so may result in electric shock. If the motor is operated by turning on and off the power supply, turn off the driver power in the event of a power failure. Otherwise, the motor may suddenly start when the power is restored, causing injury or damage to equipment. Always turn off the power before performing maintenance or inspection. Failure to do so may result in electric shock.

 CAUTION	
	<ul style="list-style-type: none"> Do not use the driver beyond the specifications. Doing so may result in fire, injury or damage to equipment. Do not touch the driver during operation or immediately after stopping. The surface is hot, and this may cause a skin burn(s). Keep the area around the driver free of combustible materials. Failure to do so may result in fire or a skin burn(s). Do not leave anything around the driver that would obstruct ventilation. Doing so may result in damage to equipment. Do not shut off the negative side of the power supply. Also, make sure that the wiring for the power supply does not disconnect. This may result in damage to equipment.
	<ul style="list-style-type: none"> Securely install the driver to the mounting plate. Inappropriate installation may cause the driver to detach and fall, resulting in injury or damage to equipment. Be sure to ground the motor and driver to prevent them from being damaged by static electricity. Failure to do so may result in fire or damage to equipment. Pay enough attention to safe operation when starting and stopping the motor by switching ON-OFF of the power supply. Failure to do so may result in injury or damage to equipment. Provide an emergency stop device or emergency stop circuit external to the equipment so that the entire equipment will operate safely in the event of a system failure or malfunction. Failure to do so may result in injury. Immediately when trouble has occurred, stop operation and turn off the driver power. Failure to do so may result in fire, electric shock or injury. Before turning on the power to the driver, make sure to turn all input signals of the driver to OFF. Otherwise, the motor may suddenly start when the power is on, leading to injury or damage to equipment.

3 Precautions for use

This chapter covers limitations and requirements the user should consider when using the product.

Use a driver and motor only in the specified combination.

Refer to "4.4 Products possible to combine" on p.7 for combinations of the driver and motor.

- Notes for continuous regeneration operation

When regeneration operation is continuously performed, check the following conditions are satisfied before use.

- Set the value of the "Deceleration mode selection" parameter to "Deceleration stop 3."
- Use a power supply that can sufficiently allow the regenerative power.



Do not perform gravitational operation (vertical drive) because a load may fall.

- Do not conduct the insulation resistance measurement or the dielectric strength test with the motor and driver connected.

Conducting the insulation resistance measurement or the dielectric strength test with the motor and driver connected may result in damage to the product.

- Note on power ON/OFF using a mechanical contact

When turning on or off the power supply using a mechanical contact (breaker, electromagnetic switch, relay, etc.), do so only the positive side (+) of the power supply using the mechanical contact.

Turning on or off the positive side (+) and the negative side (–) of the power supply simultaneously using a mechanical contact may cause damage to the control circuit or peripheral equipment.

Refer to p.11 for details.

- Note on connecting a power supply whose positive terminal is grounded

The driver's USB connector is not electrically insulated. When grounding the positive terminal of the power supply, do not connect any equipment (PC, etc.) whose negative terminal is grounded. Doing so may cause the driver and these equipment to short, damaging both.

- Noise elimination measures

Refer to p.17 for the noise elimination measures.

- Notes when saving the data to the non-volatile memory

Do not turn off the power supply while writing the data to the non-volatile memory, and also do not turn off for 5 seconds after the completion of writing the data. Doing so may abort writing the data and cause an EEPROM error alarm to generate.

The non-volatile memory can be rewritten approximately 100,000 times.

- Grease measures

On rare occasions, grease may ooze out from the gearhead. If there is concern over possible environmental contamination resulting from the leakage of grease, check for grease stains during regular inspections. Alternatively, install an oil pan or other device to prevent damage resulting from contamination. Grease leakage may lead to problems in the user's equipment or products.

- Apply grease to the hollow output shaft of a hollow shaft flat gearhead.

Apply grease (molybdenum disulfide grease, etc.) on the surface of the load shaft and the inner walls of the hollow output shaft to prevent seizure.

- Sliding noise of electromagnetic brake

Sliding noise of the brake disk for the electromagnetic brake motor may be generated during operation.

It is no functional problem.

4 Preparation

This chapter explains the items you should check, as well as the name and function of each part.

4.1 Checking the product

Verify that the items listed below are included.

Report any missing or damaged items to the branch or sales office from which you purchased the product. Refer to "4.4 Products possible to combine" for combinations of the driver and motor.

- Driver 1 unit Instructions and Precautions for Safe Use..... 1 copy

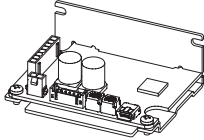

4.2 How to identify the product model

BLH2D **30** **D** **H-K** **D**
 ① ② ③ ④ ⑤ ⑥

①	Driver type	BLH2D: BLH Series driver
②	Output power	15: 15 W 30: 30 W 50: 50 W
③	Identification code	D
④	Motor connection method	Blank: Cable type H: Connector type
⑤	Power supply voltage	K: 24 VDC
⑥	Blank: Analog setting type D: Digital setting type R: RS-485 communication type	

4.3 Information about nameplate

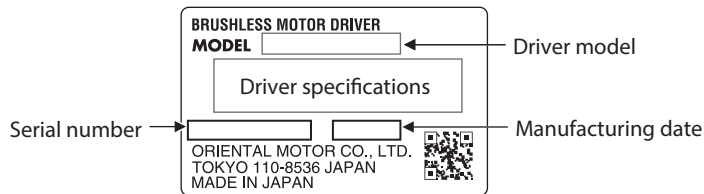

4.4 Products possible to combine

Products with which the drivers can be combined are listed below.

Verify the driver model and the motor model against the model name described on the nameplate of the product.

Motor model columns in the table below describes part of the motor model name.

For details about the motor, refer to the operating manual of the motor.

Applicable motor	Output power	Driver model	Motor model	Cable set model
BLHM Motor	15 W	BLH2D15-KD	BLHM015	LHS003CD or LHS010CD
	30 W	BLH2D30-KD	BLHM230	
	50 W	BLH2D50-KD	BLHM450	
BLM Motor	15 W	BLH2D15H-KD	BLM015HK	
		BLH2D30DH-KD	BLM030DHK	
	30 W	BLH2D30H-KD	BLM230HK	
		BLH2D50DH-KD	BLM250DHK	
		BLH2D50H-KD	BLM450HK	

● Cable set (Each cable can be purchased separately.)

- I/O signal cable 1 pc
- Power supply cable 1 pc



Length	Cable set model	I/O signal cable	Power supply cable
300 mm (11.8 in.)	LHS003CD	LH003C4	LH003C1
1000 mm (39.4 in.)	LHS010CD	LH010C4	LH010C1

4.5 Names and functions of parts

This section explains the name and function for each part of the driver.

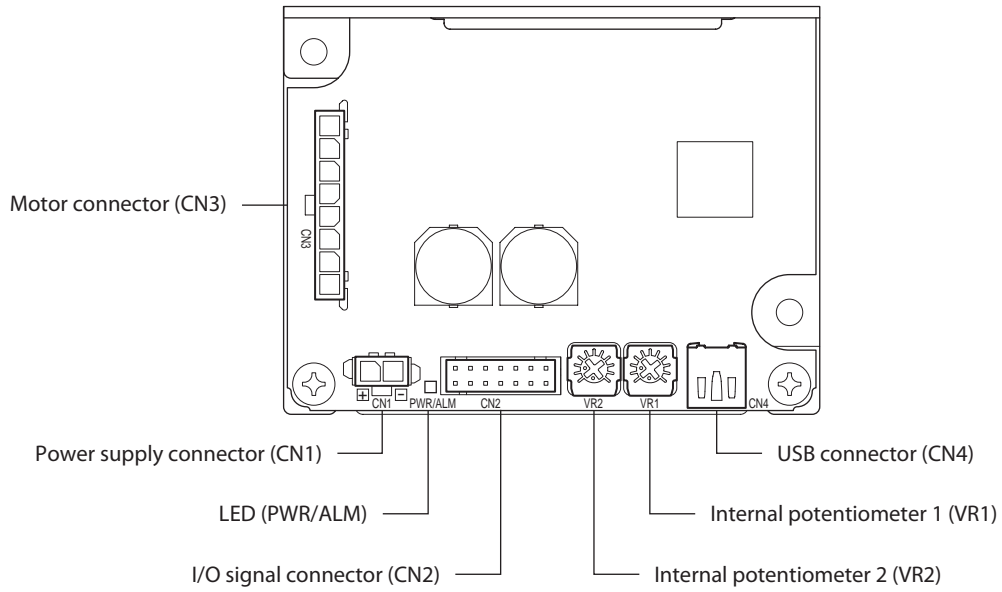

Name	Indication	Description
Power supply connector	CN1	Connects the power supply cable.
I/O signal connector	CN2	Connects the I/O signal cable to connect with an external control device.
Motor connector	CN3	Connects the motor cable.
USB connector	CN4	Connects a PC in which the MEXE02 has been installed.
LED	PWR/ALM	Lit in green while the power is supplied. If an alarm is generated, this LED will blink in red. If information is generated, it will blink in orange.
Internal potentiometer *	VR1	Uses to set the operation data. Factory setting: The rotation speed in the operation data No.1 can be set.
	VR2	Uses to set the operation data. Factory setting: The acceleration time and deceleration time in the operation data No.0 and No.1 can be set.

* The function can be changed using the **MEXE02**.

5 Installation

5.1 Installation location

The driver is designed and manufactured to be incorporated in equipment.

Install it in a well-ventilated location that provides easy access for inspection. The location must also satisfy the following conditions:

- Inside an enclosure that is installed indoors (provide vent holes)
- Operating ambient temperature: 0 to +50°C [+32 to +122 °F] (non-freezing)
- Operating ambient humidity: 85% or less (non-condensing)
- Area that is free of explosive atmosphere or toxic gas (such as sulfuric gas) or liquid
- Area not exposed to direct sun
- Area free of excessive amount of dust, iron particles or the like
- Area free of excessive salt
- Area not subject to splashing water (rain, water droplets), oil (oil droplets) or other liquids
- Area not subject to continuous vibration or excessive shocks
- Area free of excessive electromagnetic noise (from welders, power machinery, etc.)
- Area free of radioactive materials, magnetic fields or vacuum
- Altitude: Up to 1000 m (3300 ft.) above sea level

5.2 Installing the driver

■ Installation direction

The driver is designed on the basis of heat radiation by air convection and heat conduction to an enclosure.

When installing the driver in an enclosure, be sure to use the mounting holes on the driver, and install it in a vertical direction or horizontal direction.

● Vertical installation

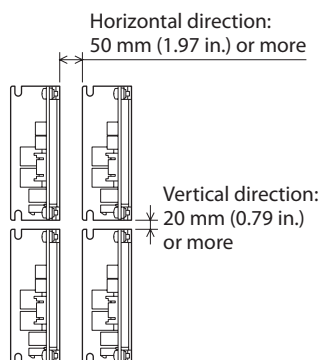

● Horizontal installation

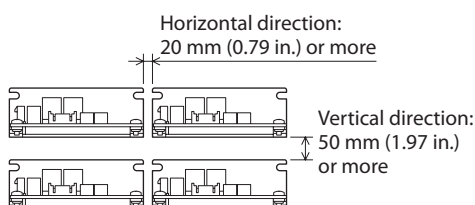

- Drivers can be installed as shown in the figure below.

When using the USB cable for communication, install them with taking the cable outlet position into account.

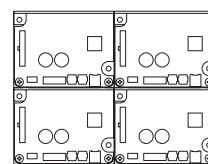

Both the vertical installation and the horizontal installation are available.

■ Installation method

Install the driver onto an appropriate flat metal plate having excellent vibration resistance and heat conductivity.

Using the mounting holes or notches of the driver, secure it with two screws (M3: not included) so as not to leave a gap between the driver and metal plate.

Note

- Do not install any equipment that generates a large amount of heat or noise near the driver.
- If the ambient temperature of the driver exceeds the upper limit of the operating ambient temperature, reconsider the ventilation condition or forcibly cool the area around the driver using a fan in order to keep within the operating ambient temperature.

6 Connection

This chapter explains how to connect the driver with the motor, power supply cable, and I/O signals.

6.1 Connecting the motor and driver (CN3)

Insert the motor cable connector into the motor connector (CN3) on the driver.

When extending the motor cable, use a connection cable (sold separately).

The maximum extension distance including the cable length of the motor itself should be 2 m (6.6 ft.).



- Firmly insert the connector in position. Insecure connector connection may cause malfunction or damage to the motor or driver.
- Be sure to insert and pull out the connector while holding the connectors part. Do not apply any force in a direction other than the direction of inserting and pulling out the connector. Applying improper force may cause damage to the connector and driver.

CN3 pin assignment

Viewed from the direction of an arrow in the right figure

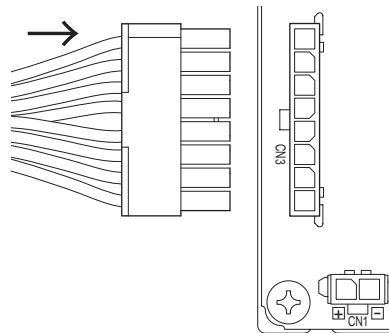
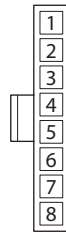

- Housing 43645-0800 (molex)
- Terminal AWG22, 24: 43030-0001 (molex)
AWG26: 43030-0004 (molex)

Pin No.	Lead wire color*	Lead wire size
1	Gray (Black)	AWG22
2	Purple	
3	Blue	
4	Yellow	AWG26
5	Green	
6	Orange	
7	Red	
8	Brown (White)	

* The color in parentheses () indicates the 15 W type.

For lead wire type and connector type, all lead wire sizes are AWG22 (15W: AWG24).

6.2 Connecting the power supply (CN1)

Insert the power supply cable connector into the power supply connector (CN1) on the driver.
Lead wire size: AWG22 (0.3 mm²)

Note

- When connecting, pay attention to the polarity of the power supply. Connection with incorrect polarity may cause damage to the driver.
- Do not wire the power supply cable of the driver in the same cable duct with other power lines or motor cables.
- When turning on the power again or inserting/pulling out the motor cable connector, turn off the power and wait for at least 5 seconds before doing so.

CN1 pin assignment

Pin No.	Lead wire color	Lead wire size
1	Red	AWG22
2	Black	

Viewed from the direction of an arrow in the right figure



Housing: 43645-0200 (molex)
Terminal: 43030-0001 (molex)

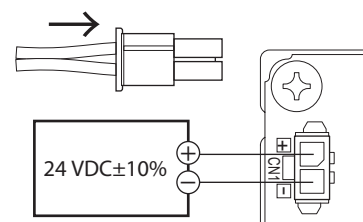

Note on power ON/OFF using a mechanical contact

- When turning on or off the power supply using a mechanical contact (breaker, electromagnetic switch, relay, etc.), do so only the positive side (+) of the power supply using the mechanical contact.

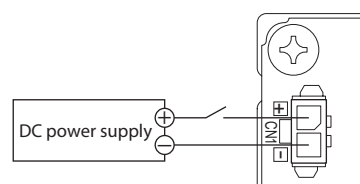

Do not turn on or off the positive side (+) and the negative side (-) of the power supply simultaneously or shut off only the negative side (-) of the power supply.
The main circuit and the control circuit in the driver are connected to the same ground. So the input current of the main circuit flows round into the control circuit when the power supply is turned on or off, causing damage to the control circuit or peripheral equipment.

6.3 Connecting the I/O signals (CN2)

Insert the connector of the I/O signal cable into the I/O signal connector (CN2) of the driver.
Lead wire size: AWG26 (0.14 mm²)

CN2 pin assignment

Viewed from the direction of an arrow in the right figure

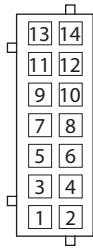

Housing: PHDR-14VS (JST)
Terminal: SPHD-001T-P0.5 (JST)

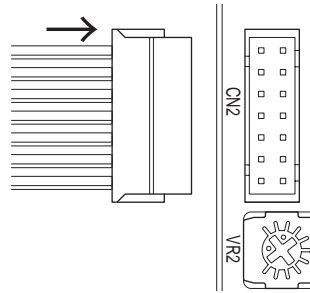

Pin No.	Lead wire color	Terminal name	Initial assignment signal *1	Description
14	Yellow/Black	DIN0	[START/STOP]	These signals are used to operate the motor. The motor rotates according to the acceleration time when both the START/STOP input and the RUN/BRAKE input are turned ON.
13	Orange/White	DIN1	[RUN/BRAKE]	If the START/STOP input is turned OFF, the motor stops according to the deceleration time. If the RUN/BRAKE input is turned OFF, the motor stops instantaneously.
12	Red/White	DIN2	[FWD/REV]	This signal is used to change the motor rotation direction. The motor rotates in the forward direction when the signal is turned ON. *2
11	Brown/White	DIN3	[M0]	The operation data number can be selected based on a combination of ON-OFF status of the M0 and M1 inputs.
10	Black	DIN4	[M1]	
9	White	DIN5	[ALM-RST]	This signal is used to reset the alarm. (The alarm will be reset at the ON edge of the input.)
8	Gray	VH	External analog setting device *3	These terminals are used when the rotation speed or torque limiting value is externally set using an external analog setting device (external potentiometer or external DC voltage).
7	Purple	VM		
6	Blue	VL		
5	Green	GND	GND	I/O signals common
4	Yellow	DOUT0	[SPEED-OUT]	30 pulses are output while the motor output shaft makes one revolution.
3	Orange	DOUT1	[ALM-B]	This is a signal to output an alarm status. It is turned OFF when an alarm is generated. (Normally closed)
2	Red	DOUT2	[TLC]	This is a signal to output when the motor output torque is limited. *4
1	Brown	DOUT3	[DIR]	This is a signal to output information of the motor rotation direction. (It is turned ON when the motor rotates in the forward direction.)

- *1 A signal assigned at the time of shipment is described in brackets []. Functions for the pin No.1 to No.4 and No.9 to No.14 can be changed using the **MEXE02**.
- *2 The rotation direction of the output shaft varies depending on the gear ratio of the gearhead.
The rotation direction can be changed by setting of the "Motor rotation direction" parameter.
- *3 If the "External setting method" parameter is changed, the rotation speed and torque limiting value can be set with the PWM signal input.
- *4 The torque limiting value is set to 200% at the time of shipment and can be changed using the **MEXE02**.

6.4 Driver I/O circuit

■ Input signals circuit

Input signals of the driver are C-MOS inputs.

The signal state represents "ON: 0 to 0.5 V (L level)" and "OFF: 4 to 5 V (H level)."

- External control device output is a 5 V C-MOS output

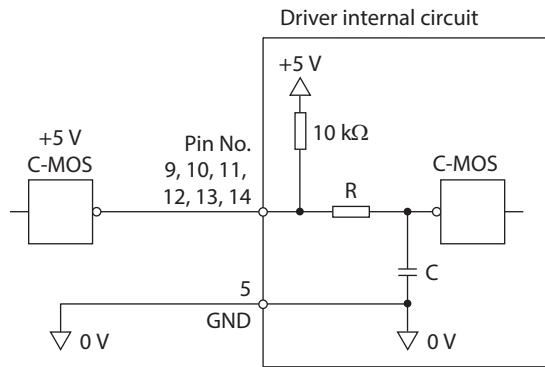

- External control device output is an open-collector output

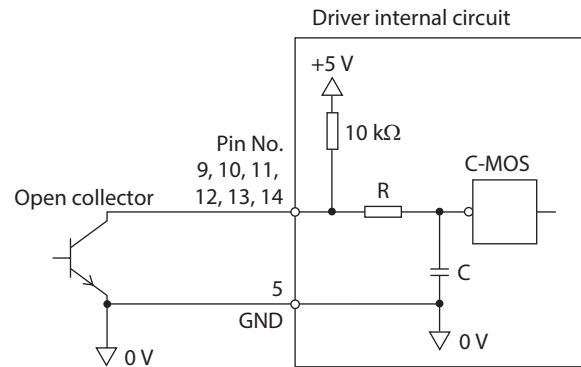

- Switch connection

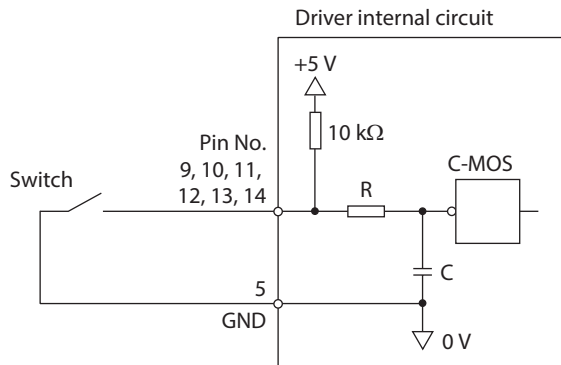

- Changing the logic level setting of input signals

The logic level setting for input terminals DINO to DIN5 can be changed using the **MEXE02**. Refer to p.66 for details.

■ Output signals circuit

Output signals of the driver are transistor open-collector outputs. The signal state represents a state of "ON: Carrying current" or "OFF: Not carrying current" for the internal photocoupler rather than the voltage level of the signal.
 ON voltage: 0.5 VDC maximum
 External power supply: 4.5 to 26.4 VDC, 10 mA or less

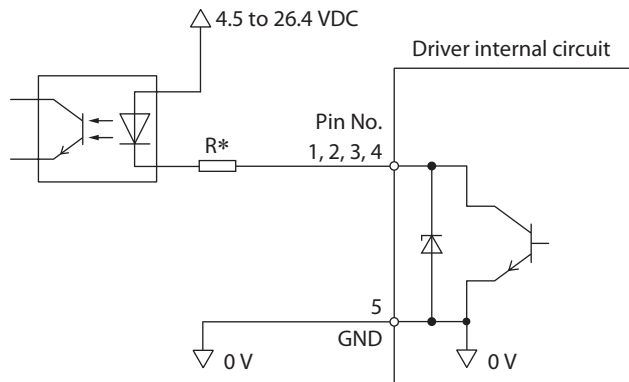

- * Recommended resistance value when a current limiting resistor R is connected:
 For 24 VDC: 2.7 k Ω to 4.7 k Ω (1 W)
 For 5 VDC: 560 Ω to 820 Ω (0.25 W)

● Changing the logic level setting of output signals

The logic level setting for output terminals DOUT0 to DOUT3 can be changed using the **MEXE02**. However, if the SPEED-OUT output is assigned, it cannot be changed. Refer to p.66 for details.

Note

- Be sure to suppress a current flowing to the output circuit at 10 mA or less. Connect a current limiting resistor R externally if the current exceeds this specified value. If the driver is used without connecting a current-limiting resistor, it will be damaged.
- When a relay (inductive load) is connected, provide a control measure for the fly-back voltage against the relay by connecting a diode. Or use a relay with built-in flywheel diode.

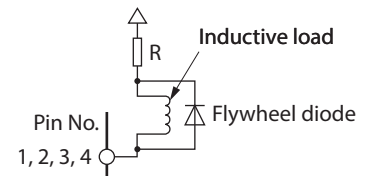

6.5 Connecting external analog setting devices

Using an external potentiometer (sold separately), external DC voltage, or PWM signal input, the rotation speed or torque limiting value can be set.

■ Using an external potentiometer

Connect to the pin No.6 to No.8 of the CN2.

memo When the **PAVR2-20K** is used, use the ferrule (rod terminal).
 Manufacturer: PHOENIX CONTACT GmbH & Co. KG
 Model: AI 0,14-8 [AWG26 (0.14mm²)]

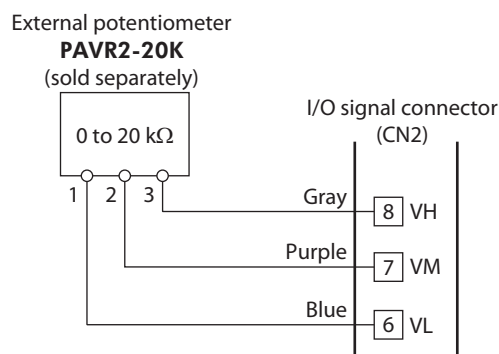

Note When a shielded cable is used for connection with the external potentiometer, connect shields to VL of the pin No.6 from near the I/O signal connector (CN2).

■ Using external DC voltage

For the external voltage, use a DC power supply (0 to 5 VDC) with reinforced insulation on its primary and secondary sides, and connect to the pin No.6 and No.7 of the CN2.

Input impedance between the VM input and VL input is approximately 47 kΩ.

The VL input is connected to GND inside the driver.

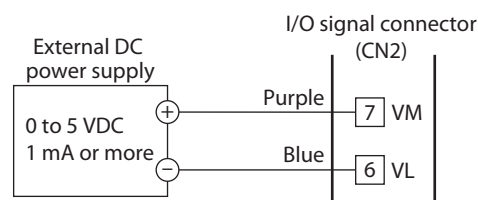

Note

- Be sure to use the voltage of an external control device at 5 VDC or lower. When connecting an external control device, make sure the polarities are correct. If the polarities are reversed, the driver may be damaged.
- When a shielded cable is used for connection with the external control device, connect shields to VL of the pin No.6 from near the I/O signal connector (CN2).

■ Using PWM signal input

When the operation data is set using the PWM signal input, connect the PWM signal lines to the pin No.6 and No.7 of the CN2.

Refer to p.58 for details about the PWM signal.

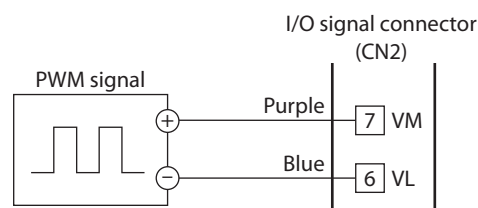

6.6 Grounding

The wire used to ground the motor and driver must be as thick and short to the grounding point as possible so that no potential difference is generated. Choose a large, thick and uniformly conductive surface for the grounding point.

- Grounding the driver
 Install the driver to a metal surface that has grounded.

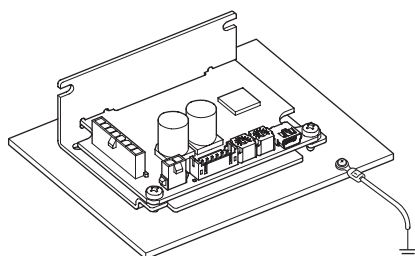

6.7 Connecting the USB cable (CN4)

Connect the USB cable to the USB connector when using the **MEXE02**.

Specifications of USB cable

Specifications	USB2.0 (full speed)
Cable	Length: 3 m (9.8 ft.) or less Shape: A to mini B



- Connect the driver and PC directly with the USB cable without using a hub or extension cable.
- In large electrically noisy environments, use the USB cable with a ferrite core or install a ferrite core to the USB cable.

6.8 Connection diagram

The figure shows an example when an external potentiometer is connected.

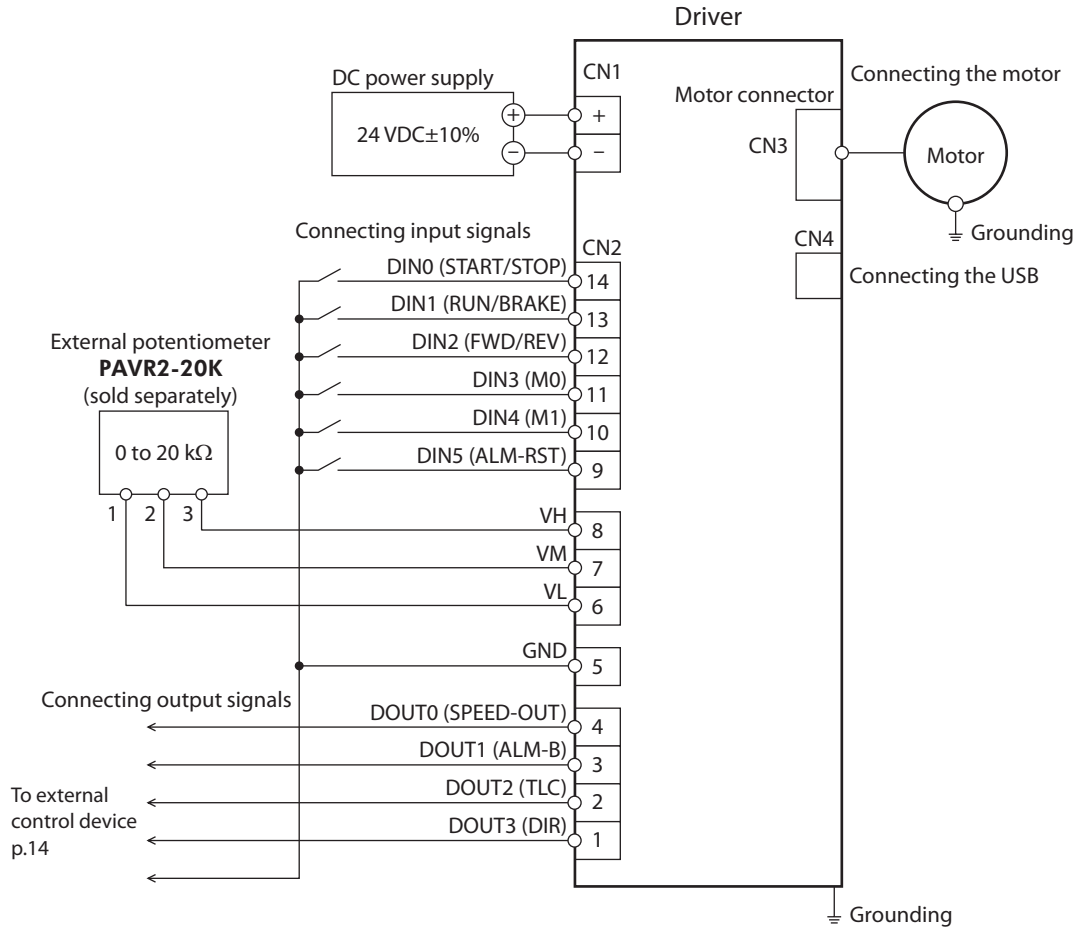

Insulate unused lead wires which are on the opposite side to the connector of the I/O signal cable to prevent them from contacting other devices, or connect them to 5 VDC or the signal ground (GND) of your external control device according to usage of signals.

6.9 Noise measures

There are two types of electrical noises: One is a noise to invade into the driver from the outside and cause the driver malfunction, and the other is a noise to emit from the driver and cause peripheral equipments malfunction.

For the noise that is invaded from the outside, take measures to prevent the driver malfunction. It is needed to take adequate measures because signal lines are very likely to be affected by the noise.

For the noise that is emitted from the driver, take measures to suppress it.

Measures against electrical noise

There are the following three methods mainly to take measures against the electrical noise.

● Noise suppression

- When relays or electromagnetic switches are used, use noise filters or CR circuits to suppress surge generated by them.
- Use a connection cable (sold separately) when extending the wiring distance between the motor and the driver. This is effective in suppressing the electrical noise emitted from the motor.
- Cover the driver by a metal plate such as aluminum. This is effective in shielding the electrical noise emitted from the driver.

● Prevention of noise propagation

- Separate power lines such as motor cable and power supply cable from signal lines for a distance of 100 mm (3.94 in.) or more, and also do not bundle them or wire them in parallel. If the power lines must cross over the signal lines, wire them at right angles.
- Use a cable of AWG26 (0.14 mm²) or thicker for the signal cable of the driver, and keep the wiring distance of 3 m (9.8 ft.) or less.
- For more effective elimination of noise, use shielded cables for a power supply cable and I/O signal cable, or attach ferrite cores if non-shielded cables are used.
- Keep cables as short as possible without coiling and bundling extra lengths.
- To ground a shielded cable, use a metal cable clamp that can maintain contact with the entire circumference of the shielded cable, and ground as near the product as possible.

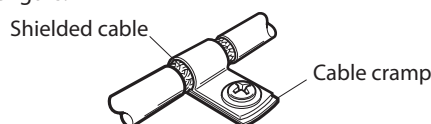

- Grounding multiple points will increase effect to block electrical noise because impedance on the grounding points is decreased. However, ground them so that a potential difference does not occur among the grounding points.

● Suppression of effect by noise propagation

- Loop the noise propagated cable around a ferrite core. Doing so will prevent the propagated noise invades into the driver or emits from the driver. The frequency band in which an effect by the ferrite core can be seen is generally 1 MHz or more. Check the frequency characteristics of the ferrite core used. When increasing the effect of noise attenuation by the ferrite core, loop the cable a lot.

6.10 Conformity to the EMC Directive

Effective measures must be taken against the EMI that the motor and driver may give to adjacent control-system equipment, as well as the EMS of the motor and driver itself, in order to prevent a serious functional impediment in the machinery. The use of the following installation and wiring methods will enable the motor and driver to be compliant with the EMC directive. Refer to p.78 for the applicable standards.

Oriental Motor conducts EMC measurements on its motors and drivers in accordance with "Example of installation and wiring" shown on the next page.

The user is responsible for ensuring the machine's compliance with the EMC Directive, based on the installation and wiring explained below.

■ About power supply

The **BLH** Series is a product of DC power supply input. Use a DC power supply (such as a switching power supply) that optimally conforms to the EMC Directive.

■ Connecting the motor cable

When extending the motor cable, use a connection cable (sold separately). The maximum extension distance including the cable length of the motor itself should be 2 m (6.6 ft.).

■ Ferrite core

Use a ferrite core to suppress effect by noise propagation.

Use 7427122 (Würth Elektronik GmbH & Co.KG), ZCAT3035-1330 (TDK Corporation) or equivalent ferrite cores.

Install the ferrite core as close as possible to the driver.

■ Wiring the I/O signal cable

Refer to "Prevention of noise propagation" on p.17.

■ Notes about installation and wiring

- Connect the motor, driver and other peripheral control equipment directly to the grounding point so as to prevent a potential difference from developing between grounds.
- When relays or electromagnetic switches are used together with the system, use noise filters and CR circuits to suppress surges generated by them.
- Keep a power supply cable and signal cable as short as possible without coiling and bundling extra lengths.
- Separate power lines such as motor cable and power supply cable from signal lines, and wire them apart as much as possible [example: about 100 to 200 mm (3.94 to 7.87 in.)]. If the power lines must cross over the signal lines, wire them at right angles.

■ Example of installation and wiring

- Driver model: **BLH2D15-KD, BLH2D30-KD, BLH2D50-KD**

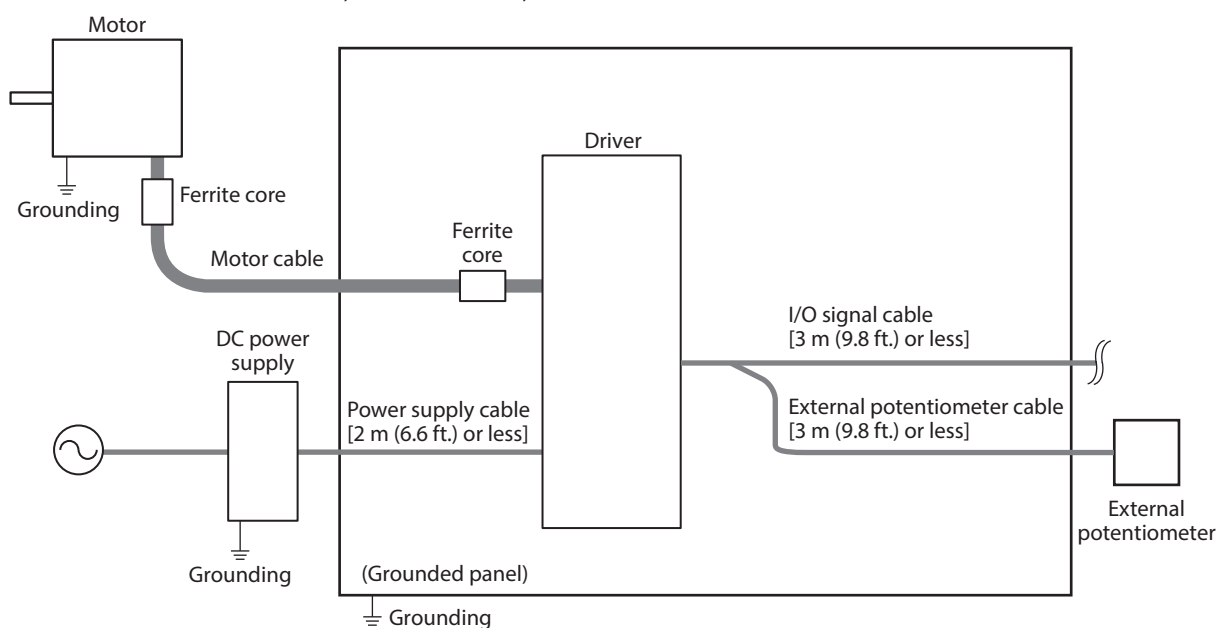

- Driver model: **BLH2D15H-KD, BLH2D30DH-KD, BLH2D30H-KD, BLH2D50DH-KD, BLH2D50H-KD**

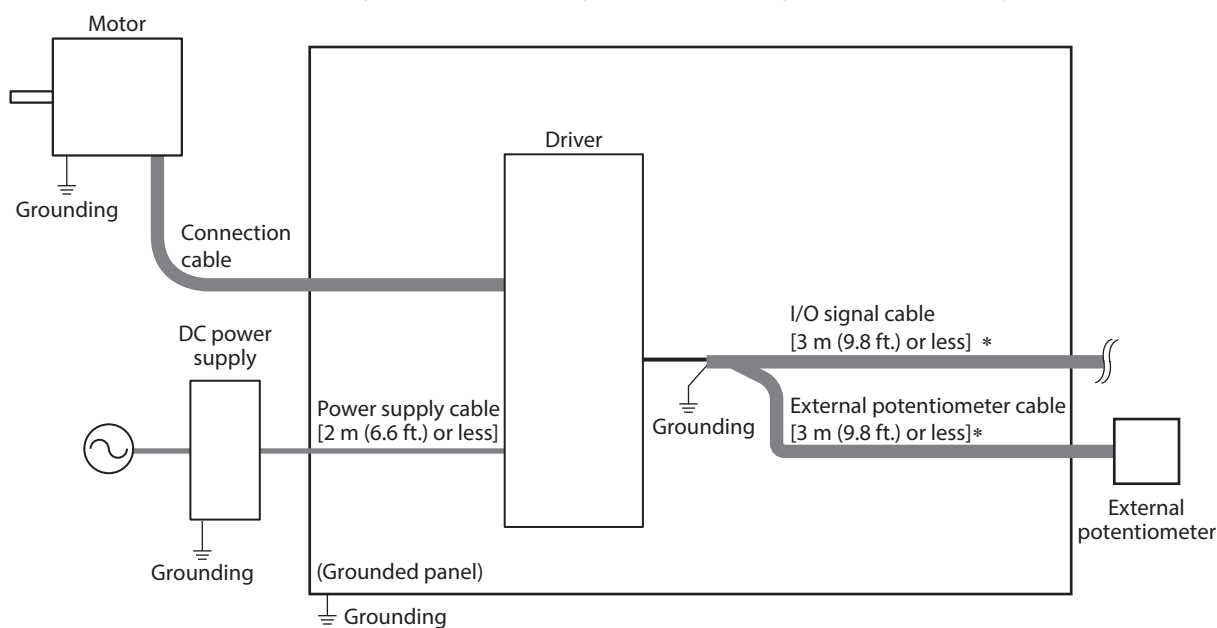

* Shielded cable

■ Precautions about static electricity

Static electricity may cause the driver to malfunction or suffer damage. Be careful when handling the driver while the power is supplied.

Always use an insulated screwdriver to adjust the internal potentiometers of the driver.

Note Do not approach or touch the driver while the power is on.

6.11 I/O signals

This section explains about input signals and output signals.

6.11.1 I/O signals list

■ Input signals

Terminal name	Signal name	Description	
DIN0	START/STOP	This signal is used to rotate the motor or decelerate to stop it.	3-Wire mode
DIN1	RUN/BRAKE	This signal is used to rotate the motor or stop it instantaneously.	
DIN2	FWD/REV	This signal is used to select the motor rotation direction.	
DIN3	M0	These signal are used to select the operation data number.	
DIN4	M1		
DIN5	ALM-RST	This signal is used to reset the alarm generated presently.	
Signals possible to change the assignment	FWD*	This signal is used to rotate the motor in the forward direction.	2-Wire mode
	REV*	This signal is used to rotate the motor in the reverse direction.	
	STOP-MODE*	This signal is used to select how to stop the motor.	
	M2	This signal is used to select the operation data number.	
	TL	This signal is used to switch whether to enable or disable the torque limiting function.	
	INFO-CLR	This signal is used to reset the information generated presently.	
	HMI	This signal is used to release the function limitation of the MEXE02 .	
	EXT-ERROR	This signal is used to stop the motor forcibly by the external signal.	
	H-FREE	This is the input signal that can be used when the load holding function is enabled. If the H-FREE input is turned ON when the stopped motor shaft is electrically held by the load holding function, the motor shaft can be rotated by an external force (free-run state).	

* This is a signal to switch using a parameter.

■ Output signals

Terminal name	Signal name	Description
DOUT0	SPEED-OUT	30 pulses are output while the motor output shaft makes one revolution in synchronization with the motor rotation.
DOUT1	ALM-B	If an alarm is generated, this output is turned OFF (normally closed).
DOUT2	TLC	When the output torque is limited, this output is turned ON.
DOUT3	DIR	Information of the motor rotation direction is output. (When the motor rotates in the forward direction: ON) The ON state will be continued until the motor will reversely rotates.
Signals possible to change the assignment	ALM-A	If an alarm is generated, this output is turned ON (normally open).
	MOVE	When the motor rotates, this output is turned ON.
	INFO	Information status of the driver is output.
	VA	When the detected speed reached the plus or minus range of "VA detection width" with respect to the setting speed, this output is turned ON.
	INFO-DRVTMP	When the corresponding information is generated, the output is turned ON.
	INFO-OVOLT	
	INFO-UVOLT	
	INFO-LOAD	
	INFO-SPD	
	INFO-SET-E	
	INFO-DRV	
	INFO-TRIP	
	INFO-ODO	
	INFO-TRQ-DE	
	INFO-SPD-DE	
	INFO-PTIME	
	INFO-PCOUNT	
	INFO-DSLMTD	
INFO-IOTEST		
INFO-CFG		
INFO-RBT		

: These signals are assigned at the time of shipment.

Refer to "I/O function selection" parameter on p.66 when changing the signal assigned to the I/O signal terminals.

6.11.2 Description of input signals

This section explains about signals that can be assigned to the direct input signals DIN0 to DIN5.

Operation input signals vary depending on the operation input mode.

The operation input mode can be changed by the setting of the "Operation input mode selection" parameter.

Refer to p.62 for details.

Operation input mode 3-Wire mode: START/STOP input, RUN/BRAKE input, FWD/REV input

2-Wire mode: FWD input, REV input, STOP-MODE input

[3-Wire mode]

■ START/STOP input, RUN/BRAKE input

The motor rotates according to the acceleration time when both the START/STOP input and the RUN/BRAKE input are turned ON.

If the START/STOP input is turned OFF while the motor rotates, the motor decelerates to a stop * according to the deceleration time.

If the RUN/BRAKE input is turned OFF while the motor rotates, the motor stops at the shortest time (instantaneous stop).

* Movement of deceleration stop can be changed by setting of the parameter.

■ FWD/REV input

This is a signal to change the motor rotation direction. The motor rotates in the forward direction when this signal is turned ON, and in the reverse direction when it is turned OFF. The figure below shows an example when the "Motor rotation direction" parameter is set to "+=CW."

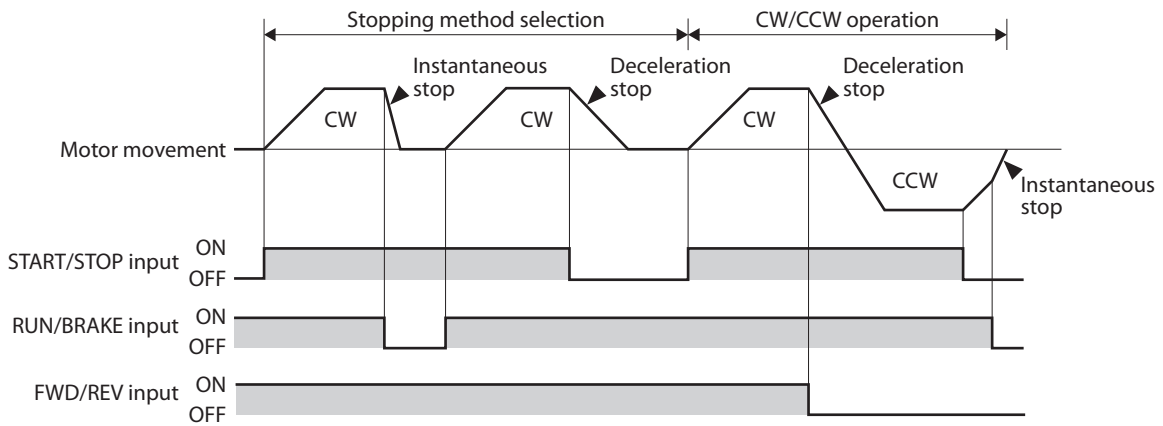

Note To surely recognize the input signal, ensure the ON time and OFF time of each input signal for at least 10 ms.

[2-Wire mode]

■ FWD input, REV input

When the FWD input is turned ON, the motor rotates in the forward direction. When it is turned OFF, the motor stops according to the STOP-MODE status.

When the REV input is turned ON, the motor rotates in the reverse direction. When it is turned OFF, the motor stops according to the STOP-MODE status.

If the FWD input and the REV input are turned ON simultaneously while the motor rotates, the motor decelerates to a stop.

The figure below shows an example when the "Motor rotation direction" parameter is set to "+=CW."

■ STOP-MODE input

This is a signal to select how the motor should stop when the FWD input and the REV input is turned OFF.

When the STOP-MODE input is OFF, the motor decelerates to a stop according to the deceleration time of the operation data number.

When the STOP-MODE input is ON, the motor stops at the shortest time (instantaneous stop).

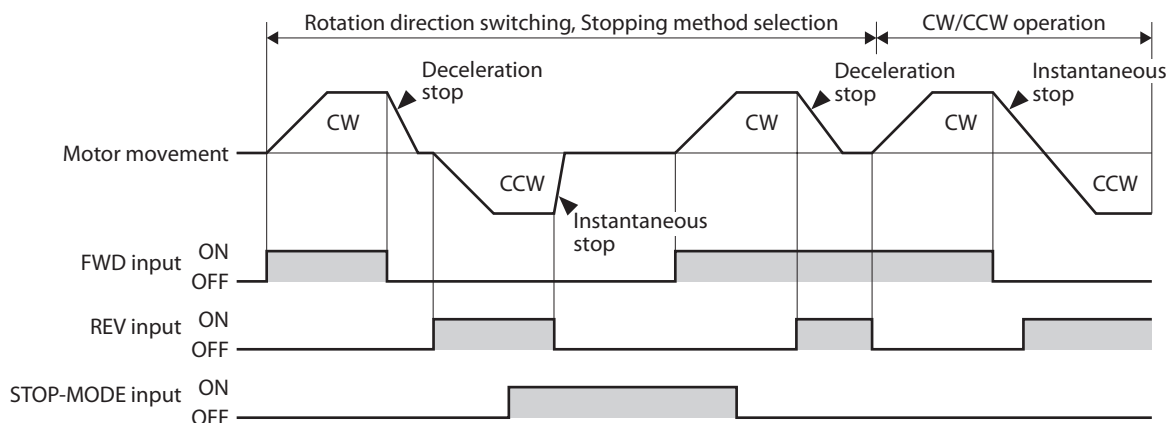

Note

- To surely recognize the input signal, ensure the ON time and OFF time of each input signal for at least 10 ms.
- When switching the FWD input and REV input, provide an interval of at least 10 ms.

■ M0 to M2 inputs

Desired operation data number can be selected by a combination of ON-OFF status of the M0 to M2 inputs.

The M0 and M1 inputs are assigned at the time of shipment. If the M2 input is assigned, the operation of 8 speeds can be performed.

Operation data No.	M2	M1	M0
0	OFF	OFF	OFF
1	OFF	OFF	ON
2	OFF	ON	OFF
3	OFF	ON	ON
4	ON	OFF	OFF
5	ON	OFF	ON
6	ON	ON	OFF
7	ON	ON	ON

■ ALM-RST input

The ALM-RST input is a signal to reset an alarm status. (The alarm will be reset at the ON edge of the input.) To reset an alarm, turn the operation input signal OFF, and remove the cause of the alarm before turning the ALM-RST input ON. In the case of the 3-wire mode, when both the START/STOP input and RUN/BRAKE input are being ON, the ALM-RST input is disabled. (In the case of the 2-wire mode, when either the FWD input or the REV input is being ON, the ALM-RST input is disabled.) If the alarm cannot be reset with the ALM-RST input, once turned off the power supply and turn on again.

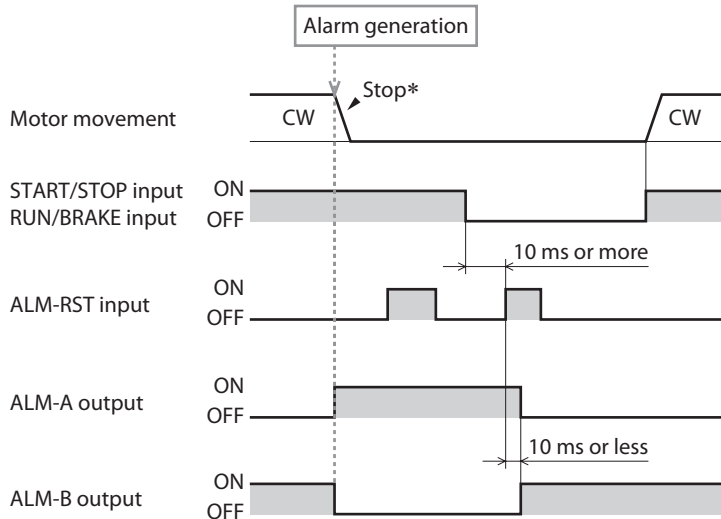

* If an alarm is generated while the motor rotates, the motor will coast to a stop.



- Continuing the operation without removing the cause of the alarm may cause damage to equipment.
- Alarms of overcurrent, EEPROM error, and CPU error cannot be reset with the ALM-RST input.

■ INFO-CLR input

The INFO-CLR input is a signal to reset an information status. (Information will be cleared at the ON edge of the input.) This signal is used when the "Information auto clear" parameter is set to disable, and the information status will be reset if it is turned ON.

Related parameters

Parameter name	Description	Setting range	Factory setting
Information auto clear	This is a function to clear the information status automatically to turn the INFO signal OFF when the cause of the generated information was removed.	Disable Enable	Enable

■ HMI input

The HMI input is a signal to release the function limitation of the **MEXE02**. (Factory setting ON)

When the HMI input is turned ON, the function limitation of the **MEXE02** is released.

When the HMI input is turned OFF, the function limitation is imposed.

[Functions to be limited]

- Operation data, writing of parameters
- I/O test
- Teaching/remote operation
- Clearing of records and others
- Configuration
- Initialization

■ TL input

The TL input is a signal to switch whether to enable or disable the torque limiting function. (Factory setting ON)

When the TL input is turned ON, the torque limiting function is enabled.

The maximum value of the motor output torque is limited based on the set torque limiting value.

When the TL input is turned OFF, the torque limiting function is disabled, and the maximum value of the motor output torque will be the peak torque.

■ EXT-ERROR input

The EXT-ERROR input is a signal for emergency stop. (Factory setting ON)
 When this signal is turned OFF, an alarm is generated to stop the motor instantaneously.

Note When the TL input, HMI input, and EXT-ERROR input are not assigned to input terminals, they are always set to ON. And if a single input is assigned to multiple input terminals, the function will be performed when all of the terminals are turned ON.

■ H-FREE input

This is the input signal that can be used when the load holding function is enabled.
 If the H-FREE input is turned ON when the stopped motor shaft is electrically held by the load holding function, the motor shaft can be rotated by an external force (free-run state).

6.11.3 Description of input signals

■ SPEED-OUT output

30 pulses are output while the motor output shaft makes one revolution in synchronization with the motor rotation. The pulse width of output pulse signals is 0.2 ms. The motor rotation speed can be calculated using the SPEED-OUT output.

$$\text{Frequency of SPEED-OUT (Hz)} = \frac{1}{T}$$

$$\text{Rotation speed (r/min)} = \frac{\text{Frequency of SPEED-OUT}}{30} \times 60$$

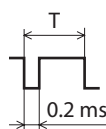

■ ALM-A output, ALM-B output

If the driver protective function is activated, an alarm will be generated. If an alarm is generated, the ALM-A output is turned ON (in the case of normally open), or the ALM-B output is turned OFF (in the case of normally closed). At the same time, the motor stops, and the PWR/ALM LED blinks in red.

If an alarm is generated while the motor rotates, the motor will coast to a stop. (Instantaneous stop at the time of external stop)

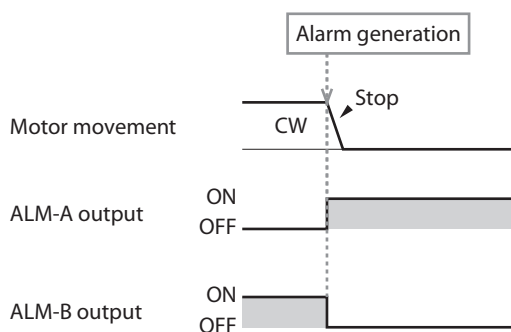

■ TLC output

When the motor output torque is limited, the TLC output is turned ON.

Note If the torque limiting value is set to less than 20%, the TLC output may not be stable.

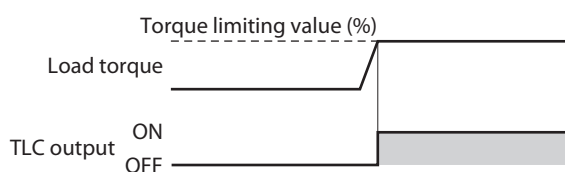

■ DIR output

This is a signal to output information of the motor rotation direction.
 The DIR output is turned ON when the motor rotates in the direction to which the positive side was set in the "Motor rotation direction" parameter.
 The ON state will be continued until the motor will reversely rotates.

Related parameters

Parameter name	Description	Setting range	Factory setting
Motor rotation direction	Sets the motor rotation direction. (Sets the rotation direction when turning the FWD input ON if the "2-wire mode" is selected with the "Operation input mode selection" parameter. Sets the rotation direction when turning the FWD/REV input ON if the "3-wire mode" is selected.)	+ =CCW + =CW	+ =CW

Example: When the "Motor rotation direction" parameter is set to "+ =CW"

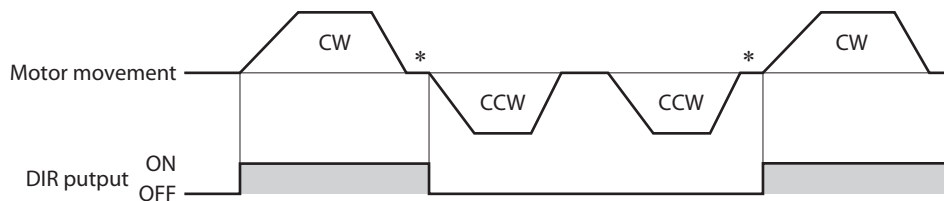

* A state just before stopping is output while the motor stops.

■ MOVE output

The MOVE output is turned ON while the motor rotates by turning the operation input signal ON.

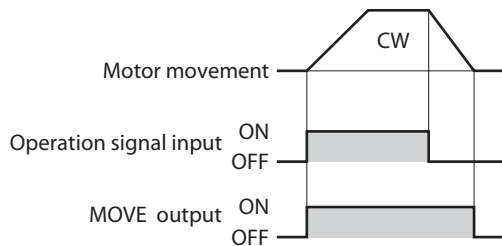

■ INFO output

If any of information is generated, the INFO output will be turned ON.
 You can select whether the INFO output is applied for each information.

■ VA output

When the detected speed reached the "plus or minus range of VA detection width with respect to the setting speed," this output is turned ON.

A range to turn the VA output ON can be set using the "VA detection width" parameter.

Related parameters

Parameter name	Description	Setting range	Factory setting
VA detection width	Sets the detection width for the VA output.	1 to 400 [r/min]	200

Example: When the motor speed changes from the setting speed 1 to the setting speed 2

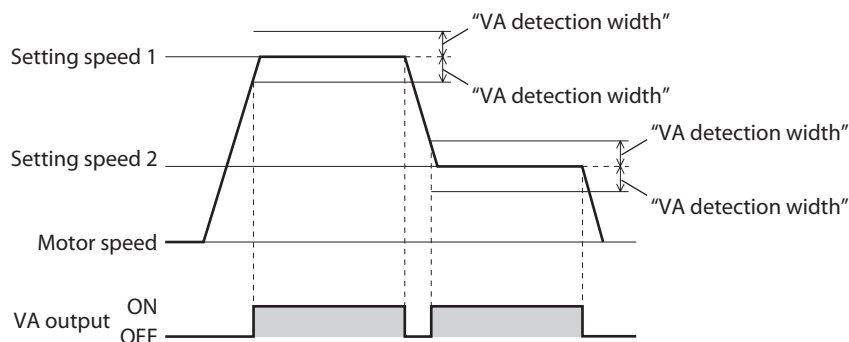

■ Information bit output

If corresponding information is generated, each output signal is turned ON.

Information	Information bit output signal
Driver temperature	INFO-DRVTMP
Overvoltage	INFO-OVOLT
Undervoltage	INFO-UVOLT
Load	INFO-LOAD
Speed	INFO-SPD
Operation data setting error	INFO-SET-E
Operation prohibited	INFO-DRV
Tripmeter	INFO-TRIP
Odometer	INFO-ODO

Information	Information bit output signal
Torque limiting value setting error	INFO-TRQ-DE
Rotation speed setting error	INFO-SPD-DE
Main power supply time	INFO-PTIME
Main power supply count	INFO-PCOUNT
Operation start limit mode	INFO-DSLMTD
I/O test mode	INFO-IOTEST
Configuration request	INFO-CFG
Power cycling request	INFO-RBT

7 Operation

7.1 Guidance

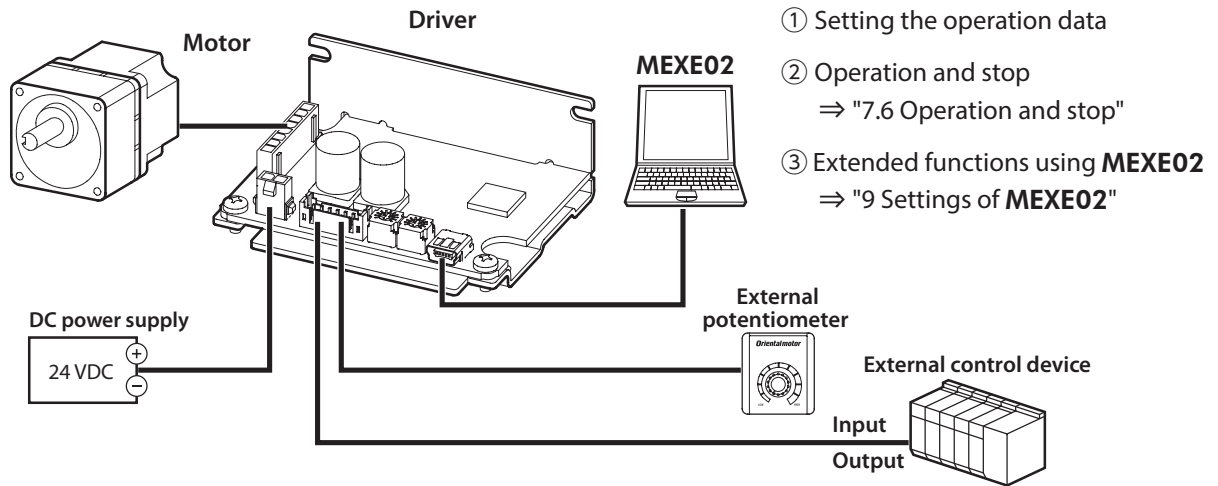

- ① Setting the operation data
- ② Operation and stop
⇒ "7.6 Operation and stop"
- ③ Extended functions using **MEXE02**
⇒ "9 Settings of **MEXE02**"

7.2 Setting the operation data

7.2.1 Operation data types

Up to 8 operation data can be set. (Operation data No.0 to No.7)

Item	Description
Rotation speed	Sets the motor rotation speed.
Acceleration time	Sets the acceleration time as a time needed for the motor to reach 3000 r/min from a standstill state.
Deceleration time	Set the deceleration time as a time needed for the motor to stop from 3000 r/min.
Torque limiting value	Sets when the output torque of the motor is limited. Sets the torque limiting value based on the motor rated torque being 100%.

7.2.2 Setting methods

Each operation data can be set by any of the following methods.

Rotation speed ⇒ p.30		Acceleration time and deceleration time ⇒ p.32		Torque limiting function ⇒ p.33	
MEXE02	External potentiometer	MEXE02	External potentiometer	MEXE02	External potentiometer
	0 to 5 VDC 1 mA or more		0 to 5 VDC 1 mA or more		0 to 5 VDC 1 mA or more
VR1	External DC voltage	VR1	External DC voltage	VR1	External DC voltage
VR2	PWM signal	VR2	PWM signal	VR2	PWM signal

7.2.3 Selecting the setting method

Setting methods of each operation data number are as follows. (Factory setting)

The setting method can be changed using the **MEXE02**. The changed items will be updated when the motor stops.

Operation data No.	Rotation speed setting method	Torque limiting value setting method	Acceleration time setting method	Deceleration time setting method
0	External analog setting device /PWM signal input	Digital	VR2	VR2
1	VR1	Digital	VR2	VR2
2	Digital	Digital	Digital	Digital
3	Digital	Digital	Digital	Digital
4	Digital	Digital	Digital	Digital
5	Digital	Digital	Digital	Digital
6	Digital	Digital	Digital	Digital
7	Digital	Digital	Digital	Digital
Setting range	Digital VR1 VR2 External analog setting device /PWM signal input	Digital VR1 VR2 External analog setting device /PWM signal input	Digital setting VR1 VR2	Digital setting VR1 VR2

- The same setting method other than the digital setting cannot be assigned to the rotation speed setting method and the torque limiting value setting method in the same operation data number.

<Example>

Operation data No.	Rotation speed setting method	Torque limiting value setting method	Acceleration time setting method	Deceleration time setting method
0	External analog setting device /PWM signal input	External analog setting device /PWM signal input	VR2	VR2



As shown in the example left, the same setting method cannot be assigned to the same operation data number.

If the same setting method was assigned, the operation data setting error information is generated.

If the operation data number that is the cause of the operation data setting error information is tried to operate, the operation prohibited information will be generated.

7.3 Setting the rotation speed

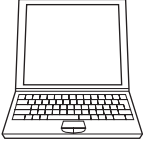
Setting method

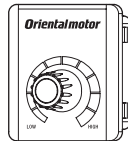
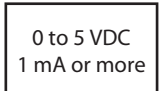
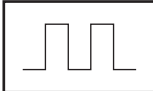
Digital	VR1	VR2	External analog setting device/PWM signal input		
 MEXE02	 VR1	 VR2	 External potentiometer	 0 to 5 VDC 1 mA or more External DC voltage	 PWM signal p.58

The setting method for each operation data number can be changed using the **MEXE02**.

If the external analog setting device/PWM signal input is selected in the setting method, you can switch whether to set with the analog setting device (external potentiometer, external DC voltage) or the PWM signal input externally using the parameter.

Change the setting method using the **MEXE02** while operation is stopped.

Digital setting

[MEXE02 Setting window of rotation speed]

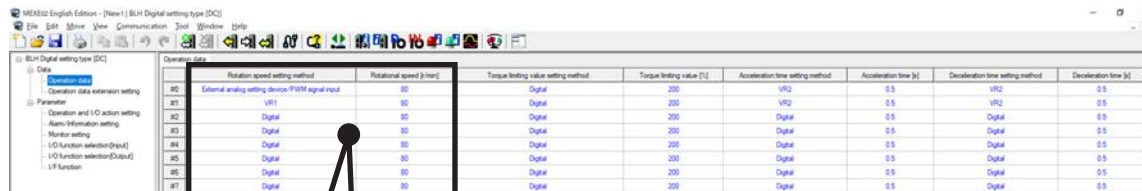

② Rotation speed setting method	① Rotational speed [r/min]
External analog setting device/PWM signal input	80
VR1	80
Digital	80
Digital	80
Digital	80
Digital	80
Digital	80
Digital	80

- The rotation speed (①) shows setting values when "Digital" is selected in the rotation speed setting method (②).

Setting range	Factory setting
80 to 3150 [r/min]	80 [r/min]

VR1 and VR2

Internal potentiometers VR1 and VR2 are used when the rotation speed is not changed frequently or is set without providing an external setting device. Adjust the potentiometer using an insulated screwdriver.

Factory setting: 0 r/min

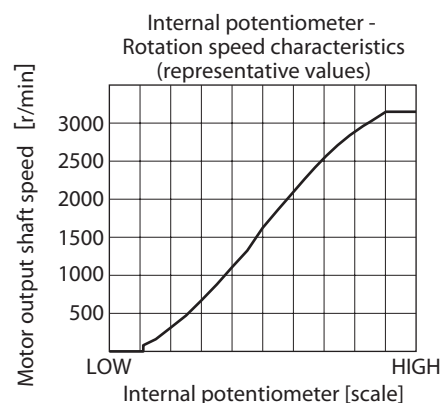
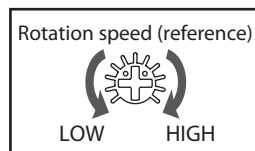
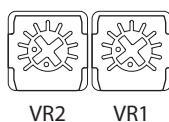

External potentiometer

An external potentiometer is used when the speed is set from a place away from the driver. Use the **PAVR2-20K** (sold separately) for an external potentiometer. Refer to p.57 when setting the upper limit and lower limit of the rotation speed.

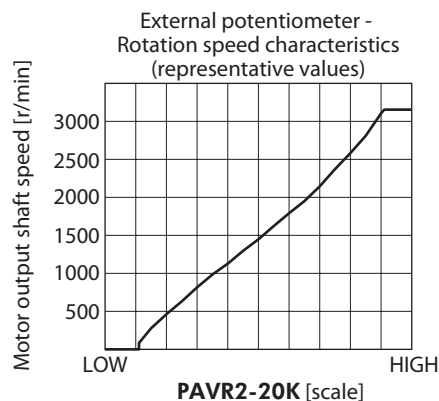
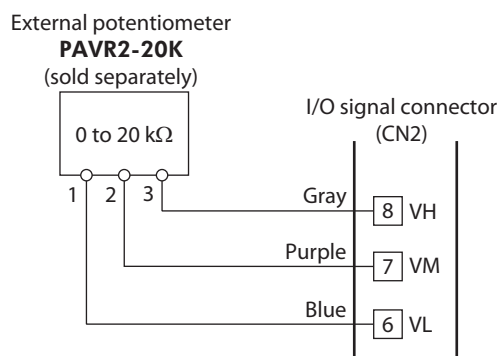
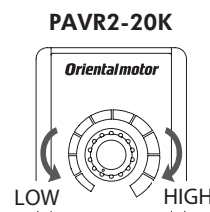

External DC voltage

External DC voltage is used when the speed is set from an external control device. For the external DC voltage, use a DC power supply (0 to 5 VDC, 1 mA or more) with reinforced insulation on its primary and secondary sides.

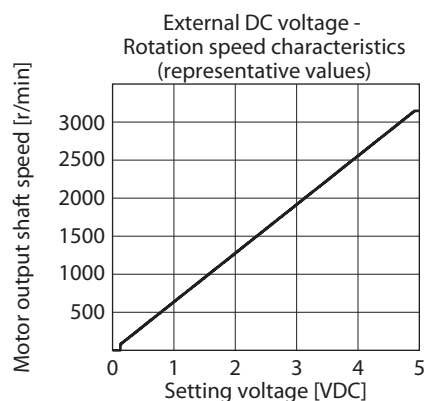
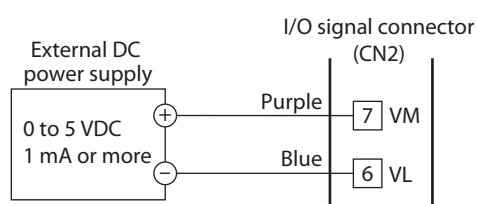

7.4 Setting the acceleration time and deceleration time



The acceleration time and deceleration time can be set so that an impact is not applied to a load when the motor starts or stops.

The actual acceleration time and deceleration time vary depending on the conditions of use, load inertia, or load torque specified by the customer.

The acceleration time refers to a time needed for the motor to reach 3000 r/min from a standstill state.

The deceleration time refers to a time needed for the motor to stop from the 3000 r/min.

Setting method

Digital	VR1	VR2
 MEXE02	 VR1	 VR2

The setting method for each operation data number can be changed using the **MEXE02**.
Change the setting method using the **MEXE02** while operation is stopped.

Digital setting

[MEXE02 Setting window of acceleration time and deceleration time]

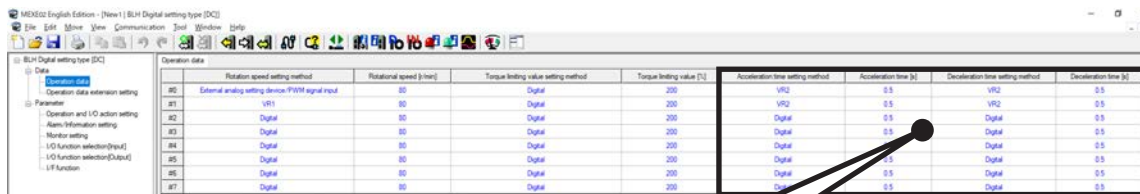

② Acceleration time setting method	① Acceleration time [s]	② Deceleration time setting method	① Deceleration time [s]
VR2	0.5	VR2	0.5
VR2	0.5	VR2	0.5
Digital	0.5	Digital	0.5
Digital	0.5	Digital	0.5
Digital	0.5	Digital	0.5
Digital	0.5	Digital	0.5
Digital	0.5	Digital	0.5
Digital	0.5	Digital	0.5

- The acceleration time and deceleration time (①) show setting values when "Digital" is selected in the setting methods (②).

Setting range	Factory setting
0.1 to 15.0 [s]	0.5 [s]

VR1 and VR2

Turning the internal potentiometer clockwise increases the acceleration time and deceleration time.

The setting range is 0.1 s to 15.0 s.

Factory setting: 0.1 s

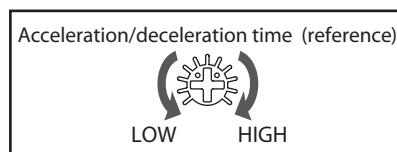
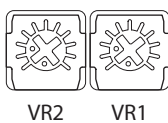

Internal potentiometer - Acceleration/ deceleration time characteristics (representative values)

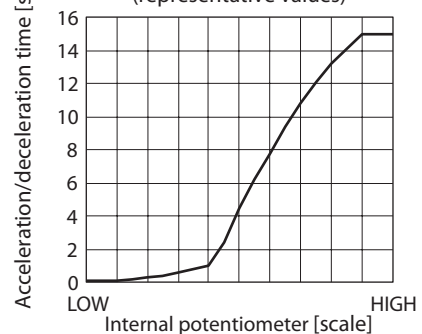

7.5 Setting the torque limiting value

The maximum output torque of the motor can be limited.
Set when suppressing the motor output torque or limiting it according to a load.
[Setting range: 0 to 200%]



TL input

When the TL input is assigned to the input terminal, enabling or disabling the torque limiting function can be switched by the ON-OFF status of the TL input.

TL input	Torque limiting function	Maximum output torque of motor
ON	Enable	The motor output torque is limited based on the set torque limiting value.
OFF	Disable	The motor output torque is the peak torque.

Note When the TL input is not assigned to the input terminal, this input will be always set to ON. If the TL input is assigned to multiple input terminals, the function will be performed when all of the terminals are turned ON.

Setting method

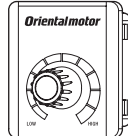
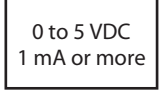
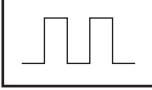
Digital	VR1	VR2	External analog setting device/PWM signal input		
 MEXE02	 VR1	 VR2	 External potentiometer	 0 to 5 VDC 1 mA or more External DC voltage	 PWM signal p.58

The setting method for each operation data number can be changed using the **MEXE02**.
You can switch whether to set with the analog setting device or the PWM signal input externally using the parameter.
Change the setting method using the **MEXE02** while operation is stopped.

Digital setting

[MEXE02 Setting window of torque speed limiting function]

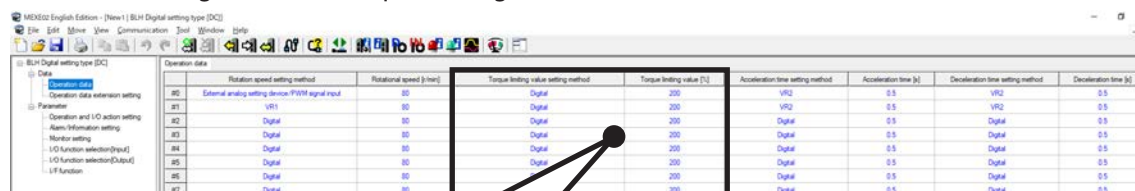

② Torque limiting value setting method	① Torque limiting value [%]
Digital	200
Digital	200
Digital	200
Digital	200
Digital	200
Digital	200
Digital	200
Digital	200

- The torque limiting value (①) shows setting values when "Digital" is selected in the setting method (②).

Setting range	Factory setting
0 to 200 [%]	200 [%]

VR1 and VR2

VR1 and VR2 are used when the torque limiting value is set without providing an external setting device. Adjust the potentiometer using an insulated screwdriver.

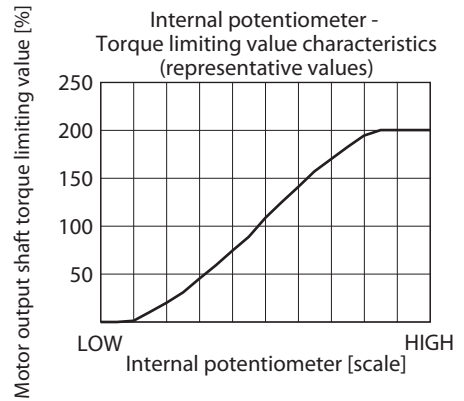
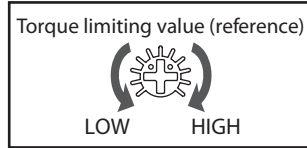
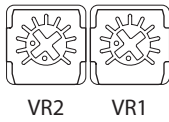

External potentiometer

When the torque limiting value is set using an external potentiometer, use the accessory **PAVR2-20K** (sold separately). Refer to p.58 when setting the upper limit and lower limit of the torque limiting value.

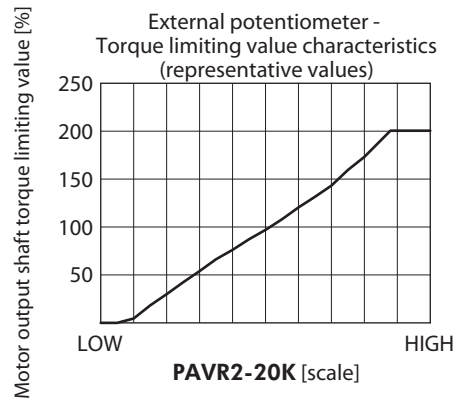
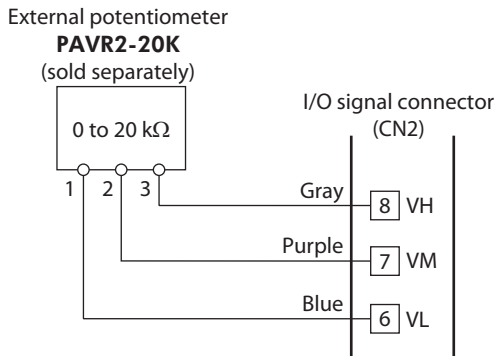
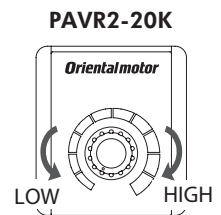

External DC voltage

Raising the applied voltage of external DC voltage increases the torque limiting value to be set, and lowering it decreases the torque limiting value to be set. (0 to 15 VDC, 1 mA or more)

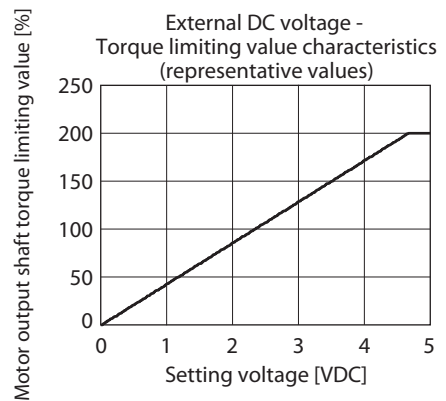
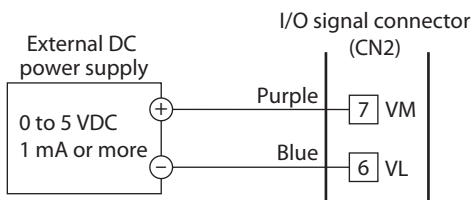

7.6 Operation and stop

To switch between operation and instantaneous stop (or stop) of the motor in the 3-wire mode, the START/STOP input and RUN/BRAKE input are used. 2-Wire mode ⇒ p.62

	START/STOP input	RUN/BRAKE input	Motor operation
Signal level	ON	ON	Operation
	ON	OFF	Instantaneous stop
	OFF	ON	Deceleration stop

If the RUN/BRAKE input is turned OFF during deceleration stop, the motor stops instantaneously.

Deceleration stop: The motor decelerates to a stop according to a time set in the deceleration time.

Instantaneous stop: The motor stops at the shortest time without following the deceleration time.



- When the START/STOP input and the RUN/BRAKE input are turned OFF simultaneously, the RUN/BRAKE input is prioritized.
- The actual acceleration time and deceleration time are affected by customer's conditions of use, load inertia, and load torque.

Examples of operation patterns

The figure shows an example of the 3-wire mode when 2000 r/min is set in the operation data No.0 and 650 r/min is set in the operating data No.1.

The rotation direction show the round shaft type. It varies depending on the gear ratio of gearhead.

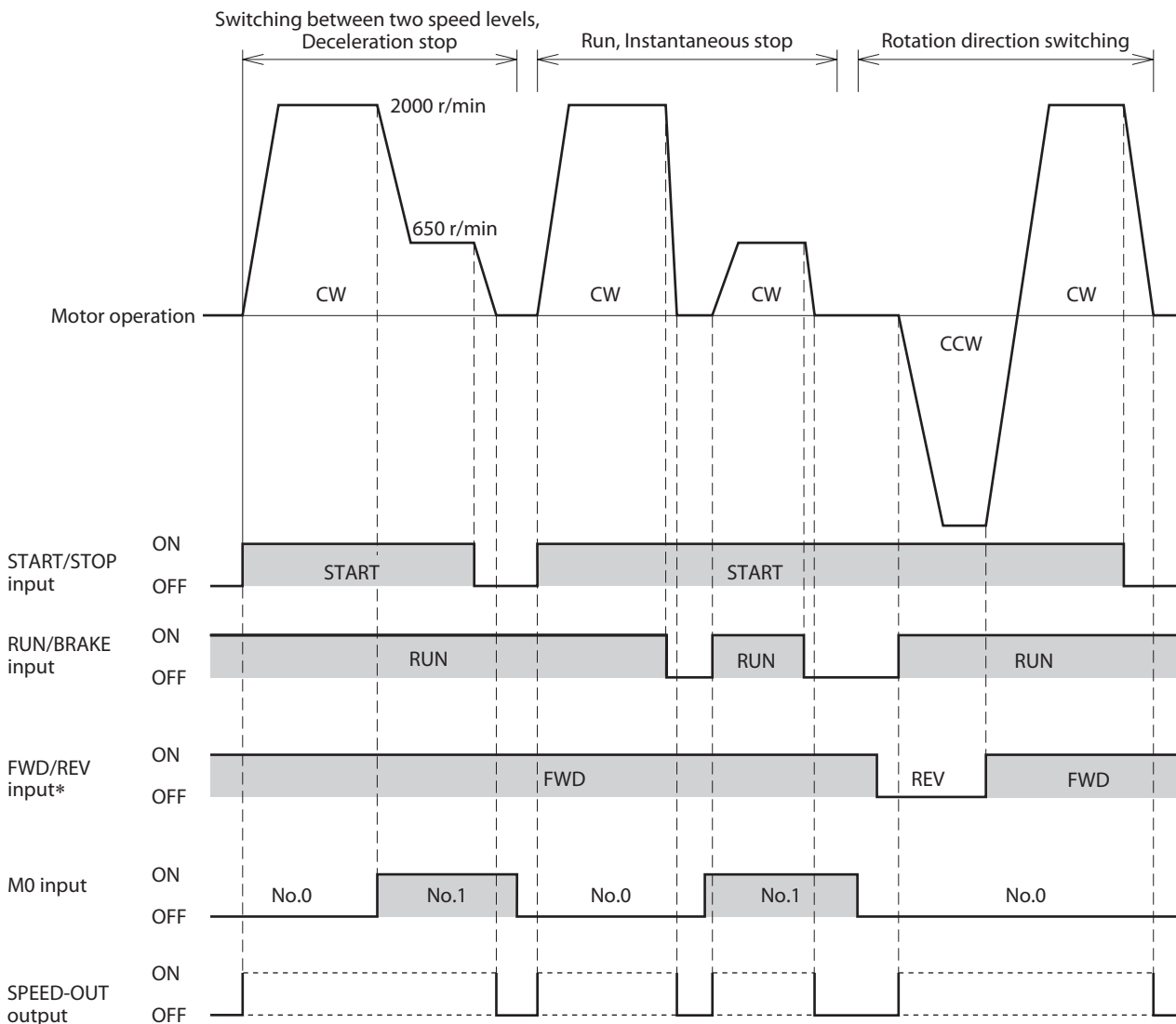

* The motor rotation direction when the FWD/REV input is turned ON can be changed by setting of the "Motor rotation direction" parameter. Refer to p.62 for details.



To surely recognize the input signal, ensure the ON time and OFF time of each input signal for at least 10 ms.

● Timing chart when power is input

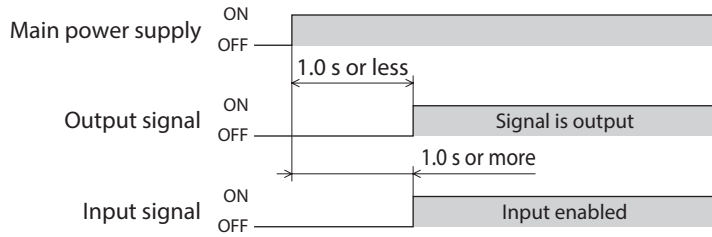

7.7 Rotation direction of the motor output shaft

The rotation direction of the motor output shaft represents the direction when viewed from the motor output shaft.

The motor rotation direction can be changed using the **MEXE02**.

The figure shows when the "Motor rotation direction" parameter is set to "+=CW."

"Motor rotation direction" parameter ⇒ p.62

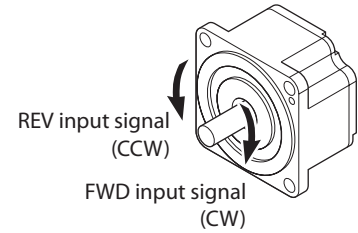

Rotation direction of the gearhead output shaft

The rotation direction of the gearhead output shaft varies depending on the type or the gear ratio of the gearhead. Check the operating manual of the motor for the rotation direction of the gearhead output shaft.

7.8 Multi-speed operation

Multi-speed operation can be performed by switching the ON-OFF status of the M0 to M2 inputs.

The M0 and M1 inputs are assigned at the time of shipment.

If the M0 to M2 inputs are assigned to the CN2, variable speed operation using up to 8 operation data can be performed.

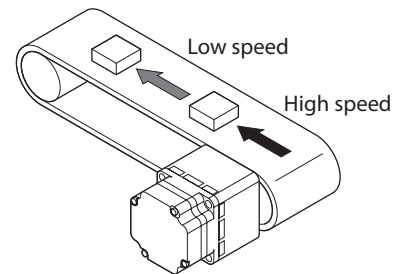

Operation data	M2	M1	M0
0	OFF	OFF	OFF
1	OFF	OFF	ON
2	OFF	ON	OFF
3	OFF	ON	ON
4	ON	OFF	OFF
5	ON	OFF	ON
6	ON	ON	OFF
7	ON	ON	ON

● When 4-speed operation is performed with the operation data No.0 to No.3

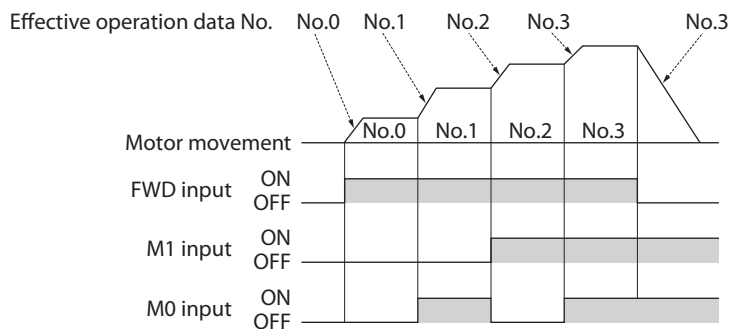

7.9 Multi-motor control

Operating two or more motors at the same speed can be performed using any of the external potentiometer, external DC voltage, or PWM signal.

Using an external potentiometer

Use common lines for the power supply and speed setting, and set the speed using VRx as shown in the figure below.

- Obtain the resistance value for the external speed potentiometer as follows.

Resistance VRx when the number of drivers is n units: $VRx (k\Omega) = 20 k\Omega/n$, permissible dissipation (W) = $n/20$

Example: If two drivers are connected, 10 kΩ and 1/10 W are obtained.

- For I/O signals other than the speed setting, connect for each driver.
- If multiple motors are used with speed differences among them, adjust as follows.
The first driver: Connect a resistor of 1.5 kΩ, 1/20 W to the terminal M on the driver.
The second and subsequent drivers: Connect a variable resistor (VRn) of 5 kΩ, 1/20 W to the terminal M on the driver.
- Keep the number of drivers to 10 units or less in multi-motor control using an external potentiometer.

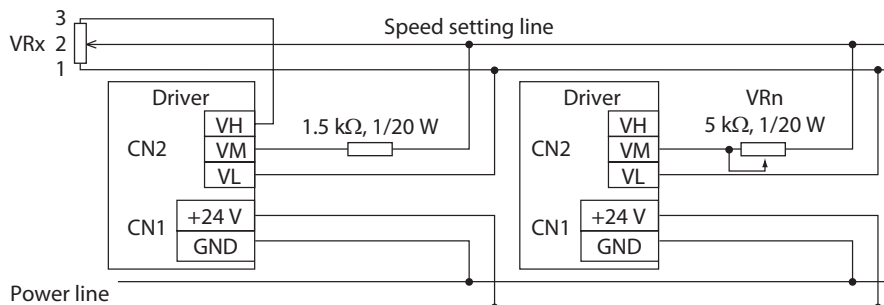

Using external DC voltage

- Use a DC power supply whose current capacity is at least the value calculated by the formula below.

Current capacity (mA) when the number of drivers is n units = $1 mA \times n$

Example: If two drivers are connected, the current capacity should be at least 2 mA.

- For I/O signals other than the speed setting, connect for each driver.
- If multiple motors are used with speed differences among them, adjust as follows.
The first driver: Connect a resistor of 1.5 kΩ, 1/20 W to the terminal M on the driver.
The second and subsequent drivers: Connect a variable resistor (VRn) of 5 kΩ, 1/20 W to the terminal M on the driver.

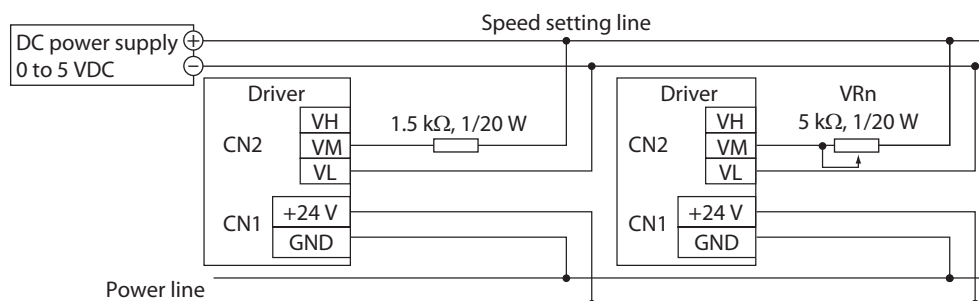

■ How to adjust the speed difference

To adjust the speed difference among the first motor and the second and subsequent motors, change the "External analog operation speed command offset" parameter. Refer to p.57 for the parameter.

When the speed difference is adjusted by changing the parameter, no resistor for adjusting the speed difference is required.

The speed difference can be adjusted by changing the "setting voltage - rotation speed characteristics" shown in the figure.

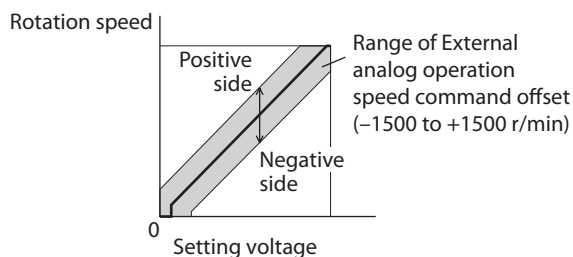

[Example]

- When the speed of the second motor is slower than that of the first motor, set a value for the positive side (0 to +1500 r/min) in the "External analog operation speed command offset" parameter of the second driver.

8 How to use MEXE02

8.1 Starting MEXE02

1. Connect a driver with a PC in which the **MEXE02** has been installed.

- 1) Start the **MEXE02**.
- 2) Connect the driver and PC with a USB cable.
- 3) Turn on the driver power.

2. Set the communication port.

- 1) Click [Communication port] from the [Setting of the communication] menu.

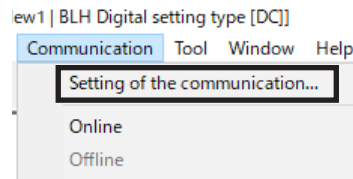

- 2) Select "ORIENTAL MOTOR/Common Virtual COM Port" and click [OK].

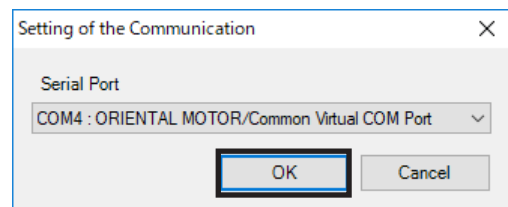

3. Select the product.

- 1) Click the [New] icon in the toolbar.

Select "**BLH**."

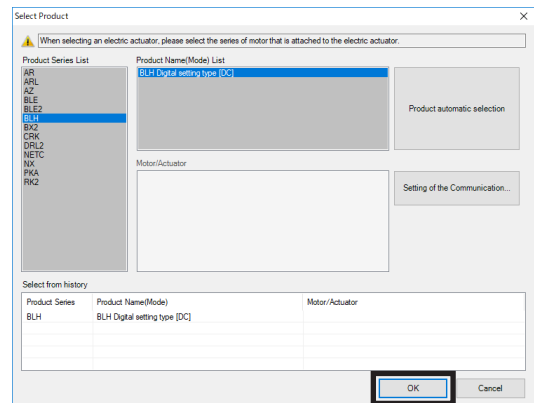

8.2 Setting the operation data

Click "Operation data" in TreeView.
The operation data edit window appears.

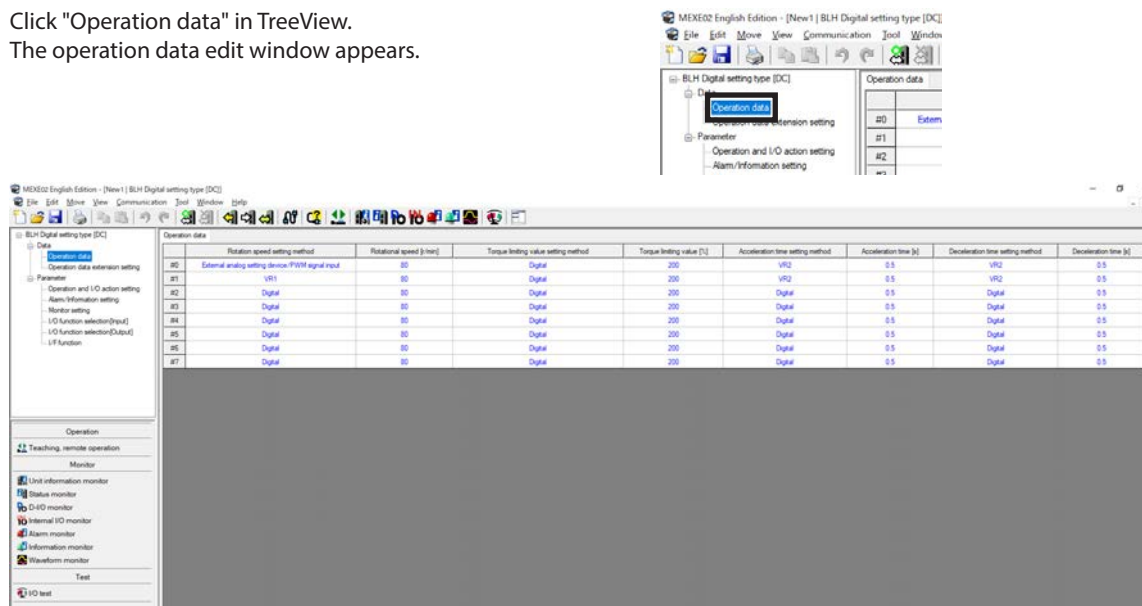

■ Data entry

The background color of a cell is initially white. When the value in the cell is changed, the color of the cell changes to yellow.
The color of characters in the cell is initially blue. When the value in the cell is changed, the color of characters changes to black.

- Entering a numeric value

Click a desired cell, and enter a value using the keyboard.

#1	VR1	80
#2	Digital	80

- Selecting a value from a pull-down menu

Double-clicking a desired cell displays a pull-down menu.
Select a desired value from the pull-down menu.

Operation input mode selection	3-Wire mode
VA detection speed range [r/min]	2-Wire mode
	3-Wire mode



Moving a cursor over a cell to be input the data can check the description, the setting range, and the update timing.

Rotational speed [r/min]	Torque limiting value setting method
80	Digital
80	Digital
80	Digital
80	Digital
80	Digital
80	Digital
80	Digital

Sets the motor rotation speed.
UNIT:1 [r/min]
RANGE:80 to 3,150 [r/min]
Initial value:80 [r/min]
Reflected:immediately

Refer to the operating manual of the **MEXE02** for how to use such as data editing method and others.

8.3 Setting the parameters

1. Open the data edit window.
2. Click the parameter group to be edited in TreeView. The parameter edit window appears.

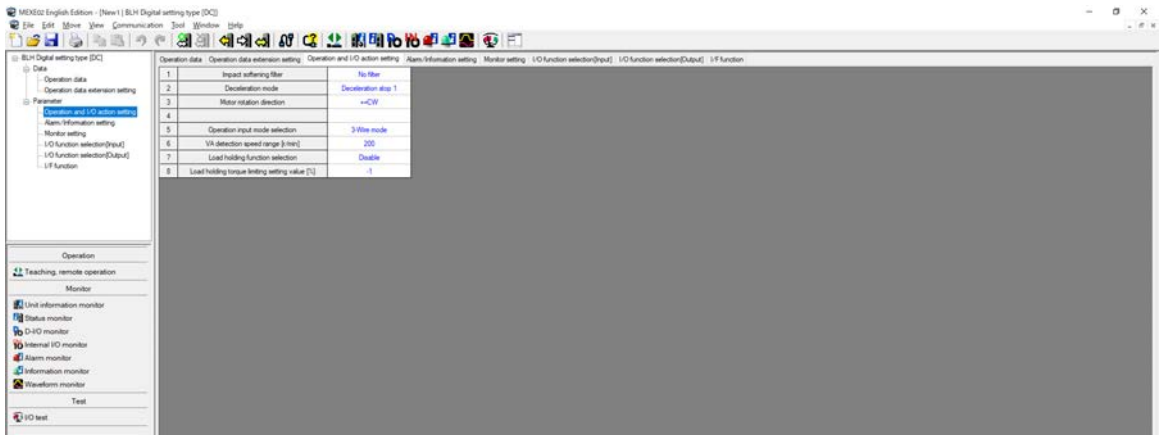
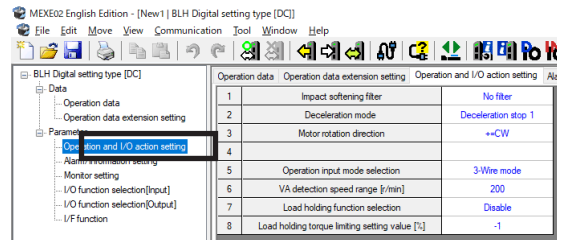

Refer to the operating manual of the **MEXE02** for how to edit the data and others.

3. Write the data to the driver after editing. Click "Data writing" in the toolbar.



8.4 Monitor

■ Unit information monitor

The unit information monitor is provided in the **MEXE02**.

If this monitor function is used, product information such as model name can be checked.

The setting value of parameters can also be checked.

1. Start "Unit information monitor" using either of the following methods.

Starting from the toolbar: Click the [Unit information monitor] icon

Starting from the shortcut button: Click [Unit information monitor]

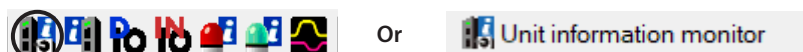

The window of the unit information monitor appears.

2. Click "Start the Unit information monitor."

The unit information monitor starts.

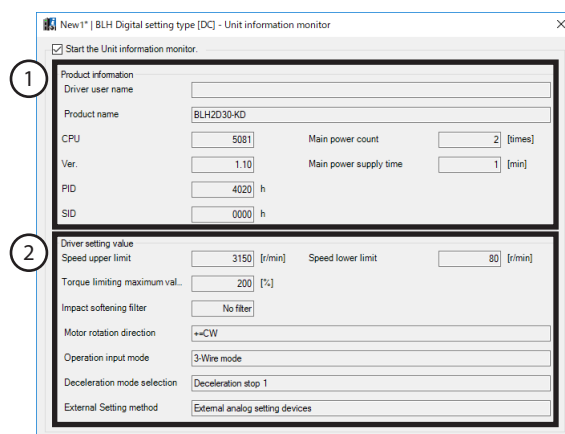

3. To exit the unit information monitor, unselect "Start the Unit information monitor."

● How to view the unit information monitor window

Area	Item	Description
Product information area	Driver user name	Monitors the name set in the "Driver user name" parameter.
	Product name	Monitors the model name of the driver.
	Ver.	Monitors the software version used.
	Main power count	Monitors the number of times that the main power supply of the driver is turned on.
	Main power supply time	Monitors the integrated value of the main power supply time of the driver.
Driver setting value area	Speed upper limit	Monitors the setting value of the "Speed upper limit" parameter.
	Speed lower limit	Monitors the setting value of the "Speed lower limit" parameter.
	Torque limiting maximum value	Monitors the setting value of the "Torque limiting maximum value" parameter.
	Impact softening filter	Monitors the setting of the "Impact softening filter" parameter.
	Motor rotation direction	Monitors the setting of the "Motor rotation direction" parameter.
	Operation input mode	Monitors the setting of the "Operation input mode selection" parameter.
	Deceleration mode selection	Monitors the setting of the "Deceleration mode selection" parameter.
External Setting method	Monitors the setting of the "External setting method" parameter.	

■ Status monitor

The present status of the **BLH** Series can be monitored.

1. Start the "Status monitor" using either of the following methods.
Starting from the toolbar: Click the [Status monitor] icon
Starting from the shortcut button: Click [Status monitor]

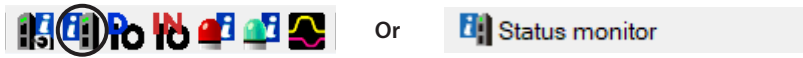

The window of the status monitor appears.

2. Click "Start Status monitor."
Status monitor starts.

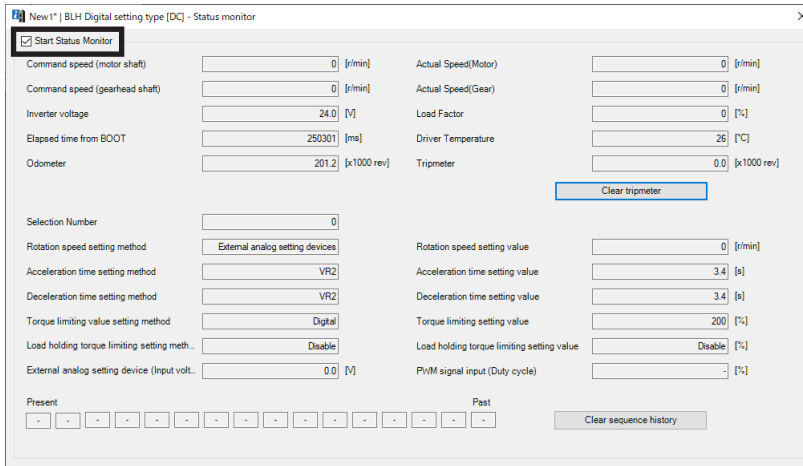

3. To exit the status monitor, unselect "Start Status monitor."

- How to view the status monitor window

Item	Description
Command speed (motor shaft)	Monitors the command speed of the motor.
Command speed (gearhead shaft)	Monitors the command speed converted by the set speed reduction ratio.
Actual Speed (Motor)	Monitors the detected speed of the motor.
Actual Speed (Gearhead)	Monitors the detected speed converted by the set speed reduction ratio.
Load Factor	Monitors the motor output torque as a load factor (The load factor is a value when the rated torque is being 100%).
Inverter voltage	Monitors the present voltage value inside the driver.
Elapsed time from BOOT	Monitors the elapsed time after turning on the power.
Driver Temperature	Monitors the present driver temperature.
Odometer	Monitors the integrated rotation amount inside the driver.
Tripmeter	Monitors the rotation amount inside the driver.
Clear tripmeter	Clears the value of the tripmeter.
Selection Number	Monitors the operation data number presently selected.
Rotation speed setting method	Monitors the setting method of the rotation speed presently set.
Acceleration time setting method	Monitors the setting method of the acceleration time presently set.
Deceleration time setting method	Monitors the setting method of the deceleration time presently set.
Torque limiting value setting method	Monitors the setting method of the torque limiting value presently set.
Load holding torque limiting setting method	Monitors the setting method of the load holding torque limiting presently set.
Rotation speed setting value	Monitors the rotation speed presently set.
Acceleration time setting value	Monitors the acceleration time presently set.
Deceleration time setting value	Monitors the deceleration time presently set.
Torque limiting setting value	Monitors the torque limiting value presently set.
Load holding torque limiting setting value	Monitors the load holding torque limiting value presently set.
External analog setting device (Input volt... *	Monitors the voltage value of the external analog setting device presently input.
PWM signal input (Duty cycle) *	Monitors the duty cycle of the PWM signal presently input.
Sequence information	Monitors the operation data numbers of the past 16 times. The sequence information can be cleared on the status monitor.
Clear sequence history	Clears sequence information.

* "-" is displayed if not selected in the "External setting method" parameter.

■ D-I/O monitor

D-I/O represents direct I/O.

In addition to the ON-OFF status of direct I/O, setting values of external analog setting device and PWM signal input can be monitored for the **BLH** Series.

1. Start the "D-I/O monitor" using either of the following methods.

Starting from the toolbar: Click the "D-I/O monitor" icon.

Starting from the shortcut button: Click "D-I/O monitor."



Or



The window of the D-I/O monitor appears.

2. Click "Start the D-I/O Monitor."

The D-I/O monitor starts.

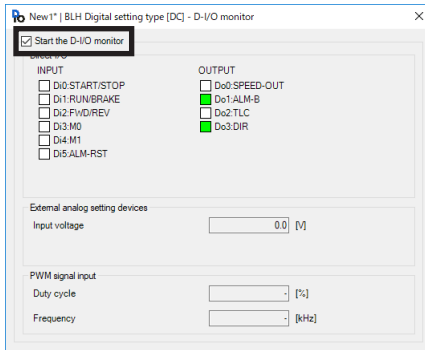

The ON-OFF status of D-I/O is indicated as follows.

Indication	Energized state
ON (green)	Conduction
OFF (white)	Non-conduction

3. To exit the D-I/O monitor, unselect "Start the D-I/O Monitor."

● How to view the D-I/O monitor window

Monitored items	Description
INPUT	Monitors the assigned input signals and each ON-OFF status.
OUTPUT	Monitors the assigned output signals and each ON-OFF status.
Input voltage *	Monitors the input voltage value of the external analog setting device.
PWM signal input *	Monitors duty cycle and frequency of the PWM signal input.

* "-" is displayed if not selected in the "External setting method" parameter.

Internal I/O monitor

All I/O signals of the **BLH** Series and the hall sensor signal detected in the driver can be monitored. Signals not assigned to direct I/O can also be checked.

1. Start the "Internal I/O monitor" using either of the following methods.
Starting from the toolbar: Click the "Internal I/O monitor" icon
Starting from the shortcut button: Click "Internal I/O monitor"

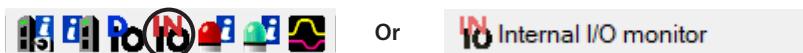

The window of the internal I/O monitor appears.

2. Click "Start the Internal I/O monitor."
The internal I/O monitor starts.

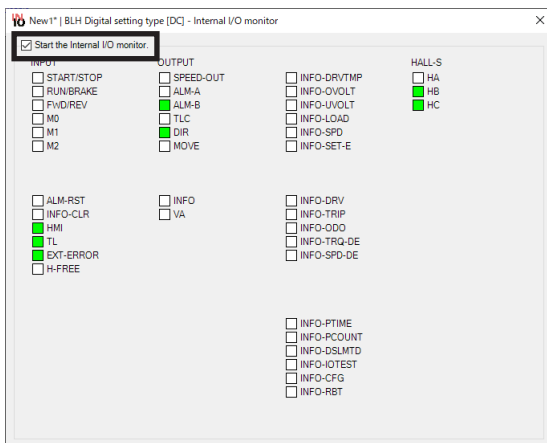

The ON-OFF status of the I/O signals is shown as follows.

Indication	Internal signal status
ON (green)	Active state
OFF (white)	Non-active state

3. To exit the internal I/O monitor, unselect "Start the Internal I/O monitor."

Alarm monitor

Alarm information of the **BLH** Series can be monitored.

1. Start the "Alarm monitor" using either of the following methods.
Starting from the toolbar: Click the "Alarm monitor" icon
Starting from the shortcut button: Click "Alarm monitor"



Or

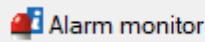

The window of the alarm monitor appears.

2. Click "Start the Alarm monitor."
The alarm monitor starts.

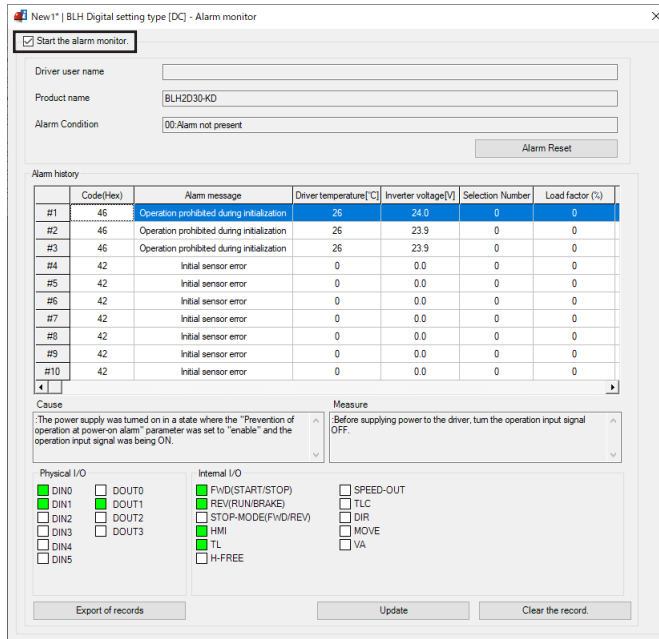

Window that the alarm history has scrolled to right

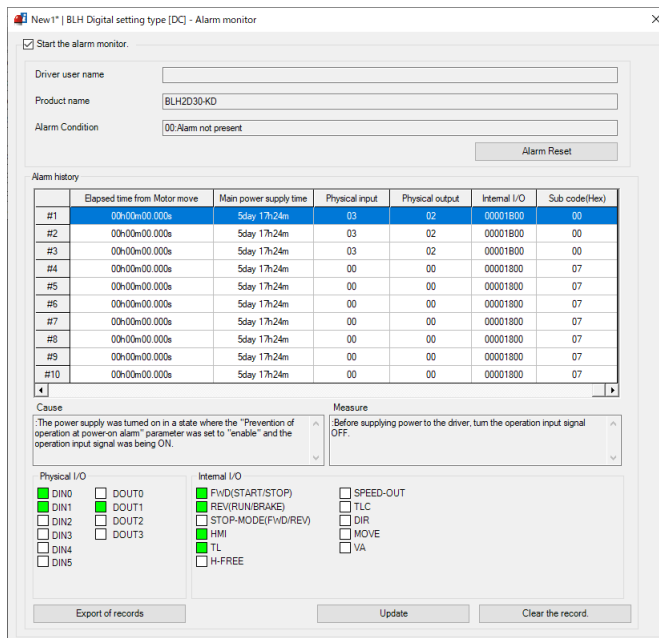

Items that can be checked in the alarm history

Item	Description
Code	This is a code to represent the content of the generated alarm.
Alarm message	This is the content of the generated alarm.
Driver temperature	Monitors the driver temperature when an alarm was generated.
Inverter voltage	Monitors the internal voltage of the driver when an alarm was generated.
Selection number	Monitors the operation data number selected when an alarm was generated.
Load factor	Monitors the load factor when an alarm was generated.
Command speed	Monitors the speed command when an alarm was generated.
Actual speed	Monitors the detected speed when an alarm was generated.
Elapsed time from BOOT	Monitors an elapsed time until an alarm was generated from power-on.
Elapsed time from starting operation	Monitors an elapsed time until an alarm was generated from the start of operation.
Main power supply time	Monitors the integrated value of time that the main power supply was turned on when the alarm was generated.
Physical input	Monitors the status of the DIN0 to DIN5 when an alarm was generated.
Physical output	Monitors the status of the DOUT0 to DOUT3 when an alarm was generated.
Internal I/O	Monitors the status of the internal I/O when an alarm was generated.
Sub code	This is our code for checking.

When the sensor error at power-on and the EEPROM error shortly after power-on are generated, "0" is shown in all fields. (Excluding the code, alarm message, and main power supply time)

- To exit the alarm monitor, unselect "Start the alarm monitor."

■ Information monitor

Information of the **BLH** Series can be monitored.

- "Start the Information monitor" using either of the following methods.
Starting from the toolbar: Click the [Information monitor] icon
Starting from the shortcut button: Click [Information monitor]



Or

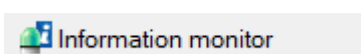

The window of the information monitor appears.

- Click "Start the Information monitor."
The information monitor starts.

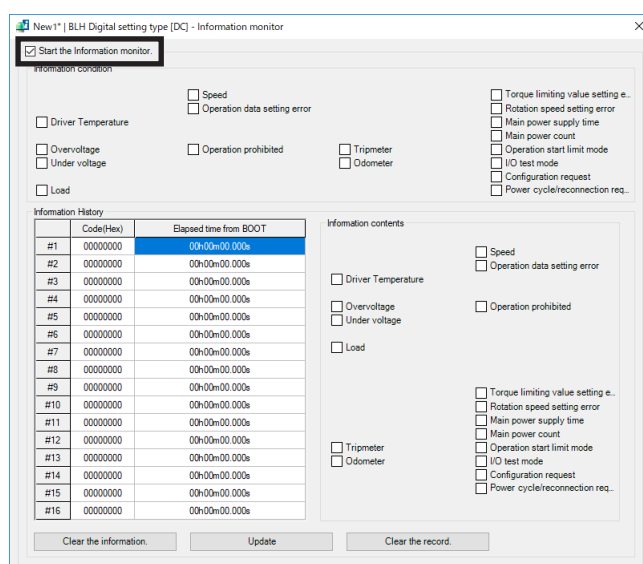

- To exit the information monitor, unselect "Start the Information monitor."

■ Waveform monitor

The motor rotation speed or the status of I/O signals can be checked in a waveform format.

1. Start the "Waveform monitor" using either of the following methods.
Starting from the toolbar: Click the [Waveform monitor] icon
Starting from the shortcut button: Click [Waveform monitor]

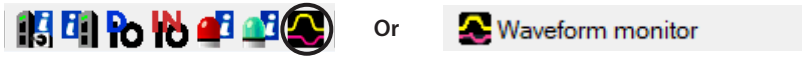

The window of the waveform monitor appears.

2. Click "Start Waveform monitor."
The buttons on the window are enabled, allowing you to prepare for measurement of the waveform monitor.

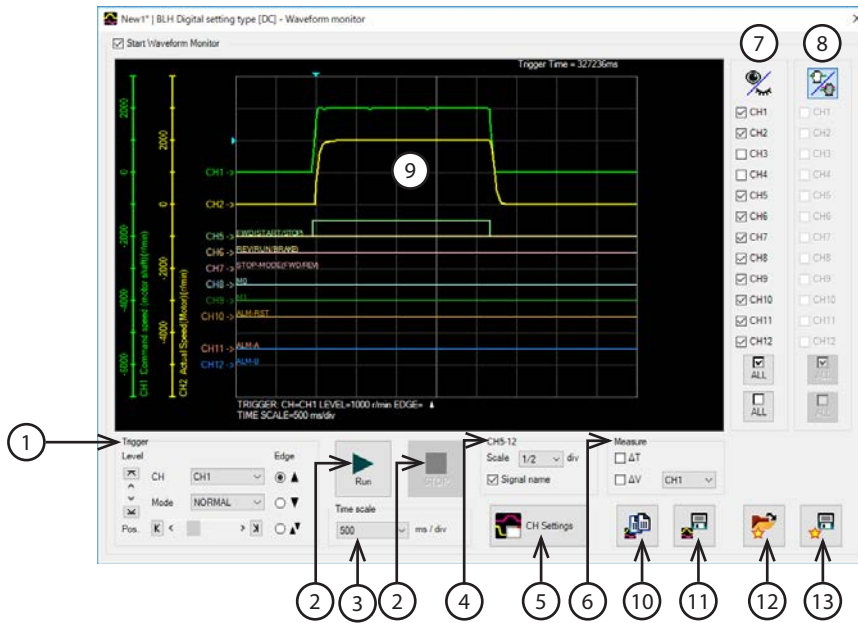

1	Sets the Pos (trigger position), Level, CH, Mode, and Edge (detection condition) that are used when a waveform is measured. For "CH," only those CHs displayed on ⑨ can be used.
2	Run: This button is used to start measurement. Stop: This button is used to stop measurement.
3	Sets the measurement time range (width).
4	Sets the display method for CH5 to CH12. Scale: Selects the display size from 1/1 (100%), 1/2 (50%), or 1/4 (25%). Signal name: Shows or hides the signal name.
5	Displays the CH setting window.
6	Shows or hides measures for measurement. Also, selects the CH to be measured.
7	Shows or hides each CH.
8	When the display position of the waveform drawn on the window is moved, the CH items selected here can be moved all together.
9	Measurement results are drawn in this area.
10	Copies the waveform presently shown to the clipboard.
11	Saves the waveform presently shown to an external file.
12	Reads the setting for measurement from "Favorites."
13	The setting for measurement can be saved as "Favorites."

3. Click the "CH Settings."

The CH setting window is shown. Set the measurement condition for each CH.

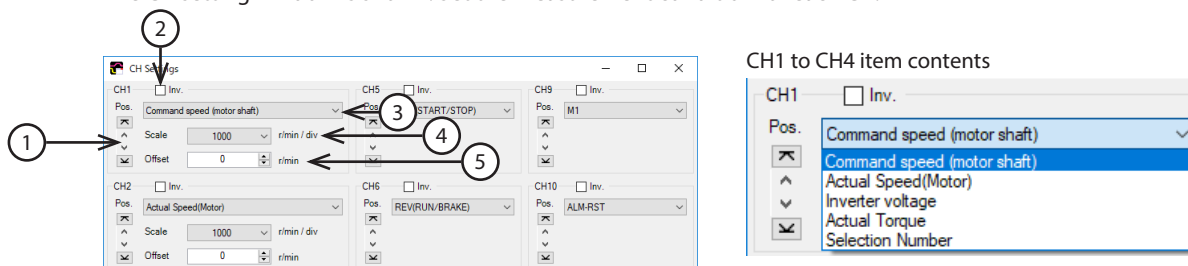

1	Moves the display position of the waveform up and down.
2	Inverts the display of measured signal.
3	Selects the signal to be measured. The CH1 to CH4 are items for the command speed, detected torque and others, and the CH5 to CH12 are items for I/O signals.
4	Selects a display scale for signals (CH1 to CH4 only). Using this in combination with ⑤ can zoom in on signals.
5	Adds the set offset value to the signal display (CH1 to CH4 only). Using this in combination with ④ can zoom in on signals.

4. Click "RUN."

Waveform measurement starts.

5. During measurement, click "Stop" to exit the waveform measurement.

If "SINGLE" is selected for Mode in Trigger, measurement automatically ends when the waveform drawing ends.

6. To exit the waveform monitor, unselect "Start Waveform Monitor."

8.5 Test operation

■ Teaching/remote operation

A motor can be operated using the **MEXE02**. The motor operation can be checked before connecting to a programmable controller.

Also, the teaching function of the operation data can be performed.

The PWR/ALM LED on the driver blinks in orange when teaching/remote operation is started.



- Teaching/remote operation and I/O test cannot be executed at the same time.
- While teaching/remote operation is performed, the motor is operated based on the data set in the teaching data. If the motor is used in a state where the output torque is limited, check the setting of the teaching data before performing teaching/remote operation.

1. Start the "Teaching/remote operation" using either of the following methods.
Starting from the toolbar: Click the "Teaching/remote operation" icon
Starting from the shortcut button: Click "Teaching/remote operation"



The window of teaching/remote operation appears.

2. Click "Start the teaching remote operation."

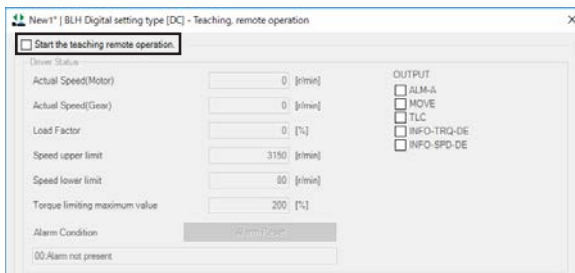

3. Click "Yes."
Teaching/remote operation is enabled.

Teaching/remote operation requires synchronization of the data under editing and the data of an applicable product. When the data is not synchronized, the following window appears. Select a synchronization method, and click "OK."

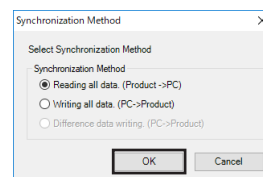
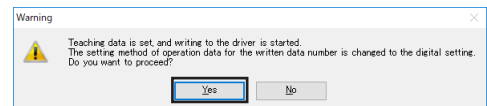

When the above window appears, all the communications in progress will be OFF. All the other monitors in progress in other windows are also stopped. Resume monitor after synchronization is completed.

4. Execute teaching/remote operation using buttons in the window.



1	Selects the operation data number that the teaching function is performed.
2	This button is used to rotate the motor in the reverse direction.
3	This button is used to rotate the motor in the forward direction.
4	This button is used to decelerate the motor to a stop.
5	This button is used to accelerate the motor rotation speed.
6	This button is used to decelerate the motor rotation speed.
7	Sets the changing value in the rotation speed when pressing 5 or 6 once.
8	This is the operation data to be changed by teaching function. The value can be changed directly.
9	This is the operation data presently written in the driver.
10*	Writes the teaching data to the operation data number.
11	This button is used instantaneously to stop the motor that is rotating by pressing 2 or 3.

* When writing the teaching data to the operation data number, execute while the motor is in a standstill state.

5. The load holding function can be operated using buttons on the window. It cannot be operated when the "Load holding function selection" parameter is set to disable.

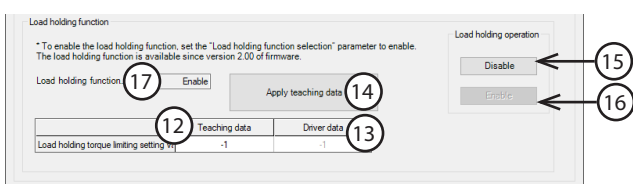

12	This is the load holding torque limiting setting value to be changed by the teaching function. The value can be changed directly. If -1 is set, the torque limiting value set to the selected operation data number is applied.
13	This is the load holding torque limiting value presently written in the driver.
14	This button is used to write the teaching data of the load holding torque limiting setting value to the driver.
15	This button is used to make the motor output shaft a free-run state.
16	This button is used to enable the load holding function.
17	This is the present status of the load holding function.

6. To exit the teaching/remote operation, unselect "Start the teaching remote operation." If "Start the teaching remote operation" is unselected while the motor rotates, the following window appears. Clicking "Yes" causes the motor to stop instantaneously.

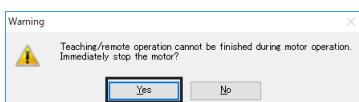

If the communication is disconnected while the motor rotates, the motor stops instantaneously.

I/O test

I/O signals of D-I/O can be tested.

Input signals can be monitored, and output signals can forcibly be turned ON or OFF to check the connection with a programmable controller.

The rotation speed or torque limiting value set by the internal potentiometer or external setting device can be checked before operating the motor.

The PWR/ALM LED on the driver blinks in orange when I/O test is started.

Refer to the operating manual of the **MEXE02** for the operating method and others.



- Output signals can forcibly be turned ON or OFF with I/O test. Therefore, other devices connected to the applicable product may operate. Before operation, check the condition of the surrounding area to ensure safety.
- Teaching/remote operation and I/O test cannot be executed at the same time.

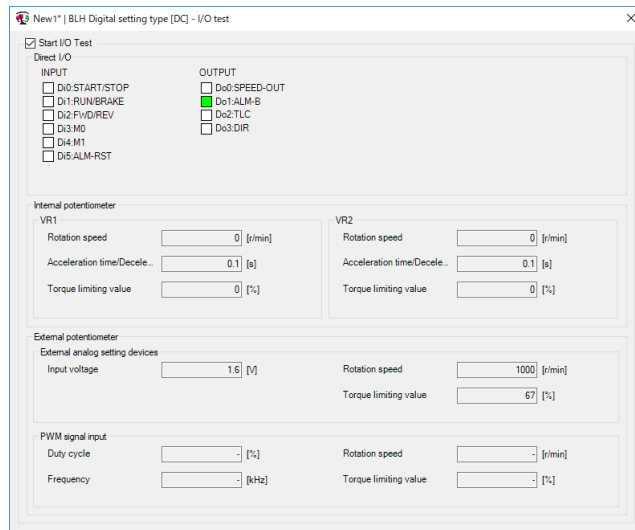

Values in the rotation speed and torque limiting value shown on the I/O test window do not follow the setting values for "Speed upper limit," "Speed lower limit," and "Torque limiting maximum value."

● Items possible to check on the I/O test monitor window

Input values from the external setting device and setting values of operation data converted from the input values are shown.

Even if the motor is not rotated actually, the setting values (rotation speed, torque limiting value, acceleration time, deceleration time) over the input values can be checked.

Values before applying the limiter function such as the speed upper limit, speed lower limit, and torque limiting maximum value are shown for the converted values.

Setting device name		Item
Internal potentiometer	VR1	Rotation speed
		Acceleration time/Deceleration time
		Torque limiting value
	VR2	Rotation speed
		Acceleration time/Deceleration time
		Torque limiting value
External potentiometer	External analog setting device	Input voltage
		Rotation speed
		Torque limiting value
	PWM signal input	Duty cycle
		Frequency
		Rotation speed
		Torque limiting value

9 Settings of MEXE02

Functions of the product can be extended by extension setting of operation data and setting of parameter using the MEXE02.

[MEXE02 Operation data extension setting window]

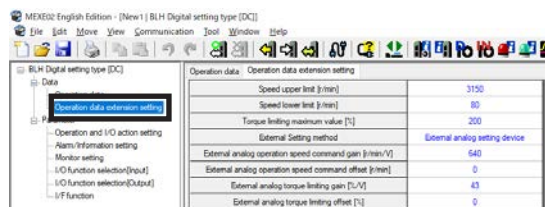

[MEXE02 Parameter setting window]

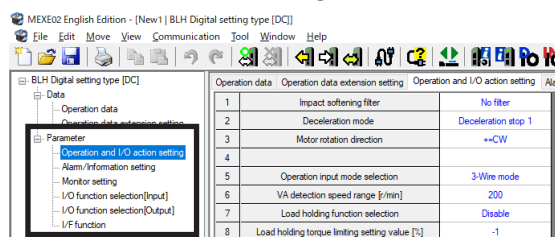

9.1 Timing to update data when the setting is changed

When a parameter is written to the driver, it is saved in the non-volatile memory. The parameter saved in the non-volatile memory is stored even after the power supply is turned off. When a parameter is changed, the timing to update the changed value varies depending on the parameter. See the following four types.

- Update immediately..... Recalculation and setup are immediately executed when the parameter is written.
- Update after operation stop..... Recalculation and setup are executed when the operation is stopped.
- Update after executing configuration Recalculation and setup are executed after configuration is executed.
Configuration is executed using the **MEXE02**.
- Update after turning on the power again... Recalculation and setup are executed after the power is turned on again.

■ Notation rules

In this chapter, each update timing is represented in an alphabet.

A: Update immediately

B: Update after operation stop

C: Update after executing configuration or turning the power again

D: Update after turning on the power again

9.2 Parameter list

	Parameter name	Setting range	Factory setting	Update	Reference page
Operation data extension setting	Speed upper limit	80 to 3150 [r/min]	3150	B	P.57
	Speed lower limit	80 to 3150 [r/min]	80		
	Torque limiting maximum value	0 to 200 [%]	200		
	External setting method	External analog setting device, PWM signal input	External analog setting device	C	
	External analog operation speed command gain	0 to 3150 [r/min/V]	640	A	
	External analog operation speed command offset	-1500 to +1500 [r/min]	0		
	External analog torque limiting gain	0 to 200 [%/V]	43		
	External analog torque limiting offset	-100 to +100 [%]	0		
Operation and I/O action	Impact softening filter	No filter, Filter 1, Filter 2	No filter	B	P.60
	Deceleration mode selection	Deceleration stop 1, Deceleration stop 2, Deceleration stop 3	Deceleration stop 1	C	
	Motor rotation direction	+=CCW +=CW	+=CW		
	Operation input mode selection	2-Wire mode, 3-Wire mode	3-Wire mode		
	VA detection width	1 to 400 [r/min]	200	A	
	Load holding function selection	Disable Enable	Disable	C	
	Load holding torque limiting setting value	-1 to 50 [%]	-1 (Operation data is followed)	A	
Alarm and information settings	Overload alarm detection time	0.1 to 10.0 [s]	10.0	A	P.64
	Prevention of operation at power-on alarm	Disable Enable	Enable	C	
	Information auto clear	Disable Enable	Enable	A	
	Driver temperature information	40 to 85 [°C]	85		
	Overvoltage information	18.0 to 38.0 [VDC]	38.0		
	Undervoltage information	18.0 to 38.0 [VDC]	18.0		
	Load information	0 (disable), 1 to 200 [%]	0		
	Speed information	0 (disable), 1 to 5200 [r/min]	0		
	Tripmeter information	0.0 (disable), 0.1 to 99999999.9 [kRev]	0.0		
	Odometer information	0.0 (disable), 0.1 to 99999999.9 [kRev]	0.0		
	Main power supply time information	0 (disable), 1 to 999,999,999 [min]	0		
	Main power supply count information	0 (disable), 1 to 999,999,999 [times]	0		
	INFO action (Driver temperature information (INFO-DRVTMP))	INFO action is not applied, INFO action is applied	INFO action is applied		
	INFO action (Overvoltage information (INFO-OVOLT))				
INFO action (Undervoltage information (INFO-UVOLT))					

Parameter name		Setting range	Factory setting	Update	Reference page
Alarm and information settings	INFO action (Load information (INFO-LOAD))	INFO action is not applied, INFO action is applied	INFO action is applied	A	P.64
	INFO action (Speed information (INFO-SPD))				
	INFO action (Operation data setting error information (INFO-SET-E))				
	INFO action (Operation prohibited information (INFO-DRV))				
	INFO action (Tripmeter information (INFO-TRIP))				
	INFO action (Odometer information (INFO-ODO))				
	INFO action (Torque limiting value setting error information (INFO-TRQ-DE))				
	INFO action (Rotation speed setting information (INFO-SPD-DE))				
	INFO action (Main power supply time information (INFO-PTIME))				
	INFO action (Main power supply count information (INFO-PCOUNT))				
	INFO action (Operation start limiting mode information (INFO-DSLMTD))				
	INFO action (I/O test mode information (INFO-IOTEST))				
	INFO action (Configuration request information (INFO-CFG))				
	INFO action (Power cycling request information (INFO-RBT))				
Monitor setting	Driver user name	Up to 16 characters	-	A	P.65
	Speed reduction ratio	100 to 9999	100		
	Speed reduction ratio digit setting	×1, ×0.1, ×0.01	×0.01		
	Speed increasing ratio	1.00 to 2.00	1.00		
I/O function selection	DIN0 input function selection	Not used, ALM-RST, INFO-CLR, HMI, TL, EXT-ERROR, FWD (START/STOP) *, REV (RUN/BRAKE) *, M0, M1, M2, STOP-MODE (FWD/REV) *, H-FREE	FWD (START/STOP) *	C	P.66
	DIN1 input function selection		REV (RUN/BRAKE) *		
	DIN2 input function selection		STOP-MODE (FWD/REV) *		
	DIN3 input function selection		M0		
	DIN4 input function selection		M1		
	DIN5 input function selection		ALM-RST		
	DIN0 logic level setting	Not invert, Invert	Not invert		
	DIN1 logic level setting		Not invert		
	DIN2 logic level setting		Not invert		
	DIN3 logic level setting		Not invert		
	DIN4 logic level setting		Not invert		
DIN5 logic level setting	Not invert				

* If the 3-wire input mode is selected with the "Operation input mode selection" parameter, the signal in the parentheses () will be applied.

Parameter name		Setting range	Factory setting	Update	Reference page
I/O function selection	DOUT0 output function selection	Not used, ALM-A, ALM-B, MOVE, INFO, TLC, VA, SPEED-OUT, DIR, INFO-DRVTMP, INFO-OVOLT, INFO-UVOLT, INFO-LOAD, INFO-SPD, INFO-SET-E, INFO-DRV, INFO-TRIP, INFO-ODO, INFO-TRQ-DE, INFO-SPD-DE, INFO-PTIME, INFO-PCONT, INFO-DSLMTD, INFO-IOTEST, INFO-CFG, INFO-RBT	SPEED-OUT	C	P.66
	DOUT1 output function selection		ALM-B		
	DOUT2 output function selection		TLC		
	DOUT3 output function selection		DIR		
	DOUT0 logic level setting	Not invert, Invert	Not invert		
	DOUT1 logic level setting		Not invert		
	DOUT2 logic level setting		Not invert		
	DOUT3 logic level setting		Not invert		
I/F function	USB-ID enable	Disable, Enable	Enable	D	P.67
	USB-ID	0 to 999,999,999	0		
	USB-PID	0 to 31	0		

9.3 Operation data extension setting

A: Update immediately, B: Update after operation stop, C: Update after executing configuration

Parameter name	Description	Setting range	Factory setting	Update
Speed upper limit	Sets the upper limit value of the speed command.	80 to 3150 [r/min]	3150	B
Speed lower limit	Sets the lower limit value of the speed command.	80 to 3150 [r/min]	80	
Torque limiting maximum value	Sets the upper limit value of torque limiting command.	0 to 200 [%]	200	
External setting method	Selects the function of the external setting device.	External analog setting device, PWM signal input	External analog setting device	C
External analog operation speed command gain	Sets the speed command per 1 VDC of the input voltage by the external analog setting device.	0 to 3150 [r/min/V]	640	A
External analog operation speed command offset	Sets the offset of the speed command by the external analog setting device.	-1500 to +1500 [r/min]	0	
External analog torque limiting gain	Sets the torque limiting value per 1 VDC of the input voltage by the external analog setting device.	0 to 200 [%/V]	43	
External analog torque limiting offset	Sets the offset of the torque limiting by the external analog setting device.	-100 to +100 [%]	0	

9.3.1 Limiting the setting range of the rotation speed

■ "Speed upper limit" parameter and "Speed lower limit" parameter

The setting range of the rotation speed is set to 80 to 3150 r/min at the time of shipment. This setting range can be changed to limit.

Setting range of rotation speed

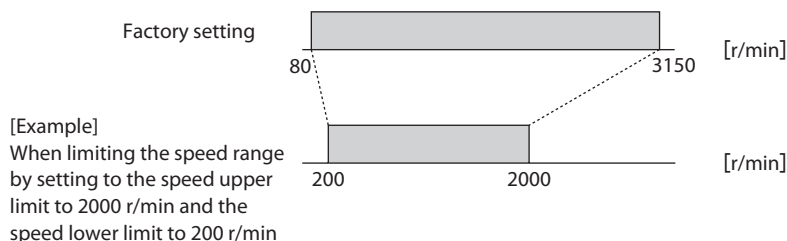

● Speed upper limit

Set the upper limit value of the rotation speed with the "Speed upper limit" parameter.

If the rotation speed exceeding the "Speed upper limit" is already set in the operation data, the rotation speed is limited to the value set in the "Speed upper limit" parameter.

● Speed lower limit

Set the lower limit value of the rotation speed with the "Speed lower limit" parameter.

If the rotation speed below the "Speed lower limit" is already set in the operation data, the rotation speed is limited to the value set in the "Speed lower limit" parameter.



When the operating rotation speed is limited to the value set in the "Speed upper limit" parameter or "Speed lower limit" parameter, the rotation speed setting error (INFO-SPD-DE) information is generated.

9.3.2 Limiting the setting range of the torque limiting value

■ "Torque limiting maximum value" parameter

The setting range of the torque limiting is set to 0 to 200% at the time of shipment.
Set when the upper limit is provided.

If the torque limiting value exceeding the "Torque limiting maximum value" is already set in the operation data, the torque limiting value is limited to the value set in the "Torque limiting maximum value" parameter.



When the torque is limited to the torque limiting value set in the "Torque limiting maximum value" parameter, the torque limiting setting error (INFO-TRQ-DE) information is generated.

9.3.3 Setting the rotation speed and torque limiting value using PWM signal

■ "External setting method" parameter

The rotation speed and torque limiting value can be set by inputting the PWM signal.

The rotation speed or torque limiting value changes according to the duty cycle of input PWM signal.

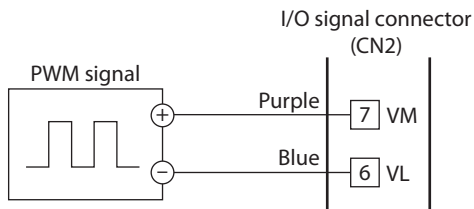

• Input signal specifications

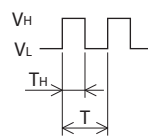

$$\text{PWM duty cycle (\%)} = \frac{T_H}{T} \times 100$$

$$\text{PWM frequency * (kHz)} = \frac{1}{T}$$

$$V_H = 4.5 \text{ to } 5.0 \text{ V} \quad V_L = 0 \text{ to } 0.5 \text{ V}$$

* Available for 1 kHz to 25 kHz

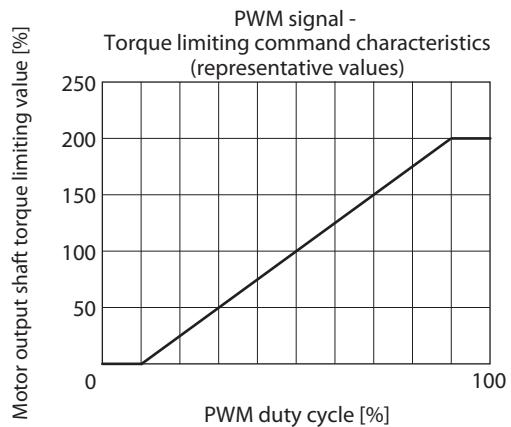
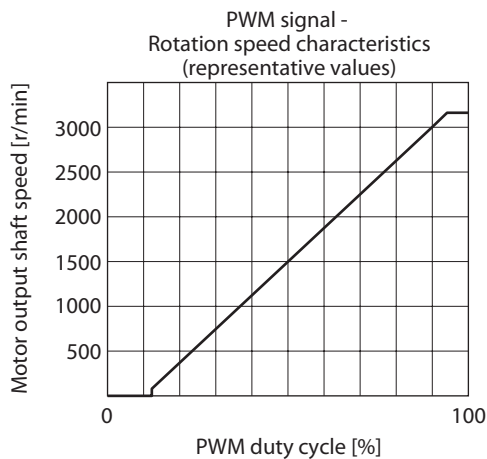

9.3.4 Adjusting gain and offset for rotation speed command

If gain and offset are adjusted when the rotation speed is set using the external DC voltage or external potentiometer, the slope of the speed command can be changed, and the speed can finely be adjusted.



The rotation speed corresponding to the voltage value varies depending on the product.

- Gain adjustment and offset adjustment for rotation speed

Adjust using the following parameters.

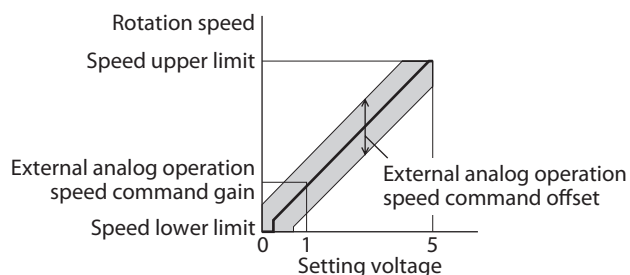

$$\text{External analog operation speed command gain}^* = \frac{\text{Speed upper limit}}{\text{Maximum value of setting voltage}}$$

* If the motor does not reach the speed upper limit when the setting voltage is the maximum value, increase the value in the "External analog operation speed command gain" parameter.

- Setting example: When the motor is operated linearly in a state where the maximum rotation speed is set to 2000 r/min

Set the "Speed upper limit" parameter to 2000 first, and set the "External analog operation speed command gain" parameter to 400.

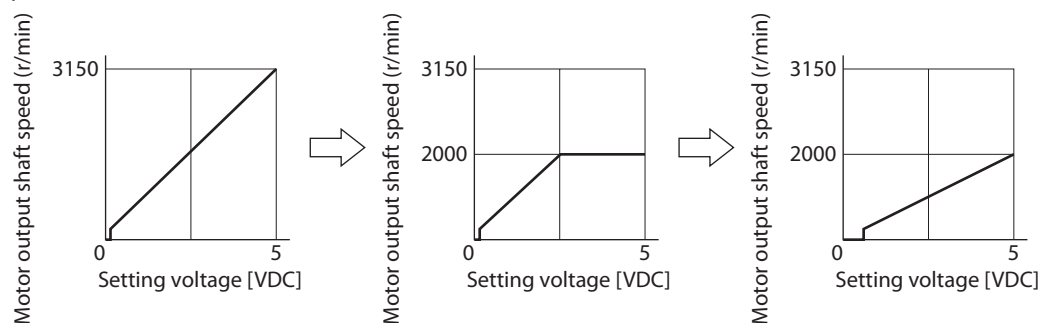

Refer to "How to adjust the speed difference" on p.37 for how to use the "Analog operation speed command offset" parameter.

9.3.5 Adjusting gain and offset for torque limiting command

If gain and offset are adjusted when the torque limiting value is set using the external DC voltage or external potentiometer, the slope of the command or the upper limit can be set.



The rotation speed corresponding to the voltage value varies depending on the products.

- Gain adjustment and offset adjustment for torque limiting value

Adjust using the following parameters.

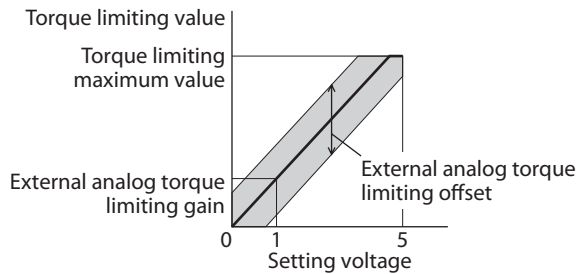

$$\text{External analog torque limiting gain*} = \frac{\text{Torque limiting maximum value}}{\text{Maximum value of setting voltage}}$$

* If the motor does not reach the torque upper limit when the setting voltage is the maximum value, increase the value in the "External analog torque limiting gain" parameter.

- Setting example: When the torque limiting value is adjusted up to 100% using the external DC voltage of 0 to 5 VDC

Set the "Torque limiting maximum value" parameter to 100 first, and set the "External analog torque limiting gain" parameter to 21.

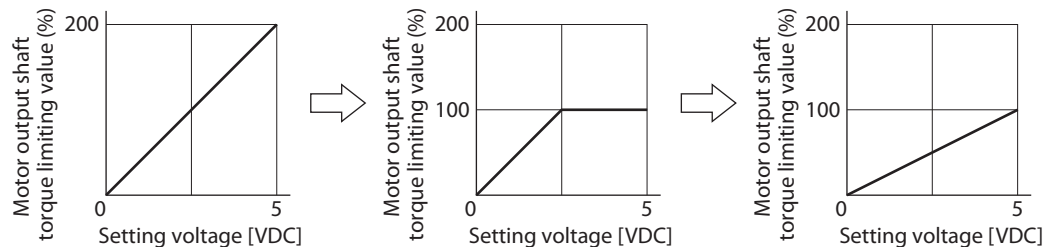

9.4 Operation and I/O action

A: Update immediately, B: Update after operation stop, C: Update after executing configuration

Parameter name	Description	Setting range	Factory setting	Update
Impact softening filter	This is a function to soften an impact being applied to a load at starting or stopping.	No filter, Filter 1, Filter 2	No filter	B
Deceleration mode selection	Selects how to stop the motor at deceleration stop.	Deceleration stop 1, Deceleration stop 2, Deceleration stop 3	Deceleration stop 1	C
Motor rotation direction	Sets the motor rotation direction. (Sets the rotation direction when turning the FWD input ON if the 2-wire mode is selected with the "Operation input mode selection" parameter. Sets the rotation direction when turning the FWD/REV input ON if the 3-wire mode is selected.)	+=CCW, +=CW	+=CW	
Operation input mode selection	Selects whether the operation input mode is used in the 2-wire mode or the 3-wire mode.	2-Wire mode, 3-Wire mode	3-Wire mode	
VA detection width	Sets the detection width for the VA output.	1 to 400 [r/min]	200	A
Load holding function selection	Selects whether to generate a force to hold the shaft electrically when the motor stops.	Disable Enable	Disable	C
Load holding torque limiting setting value	Sets the limiting value of the load holding torque. If -1 is set, the torque limiting value set to the selected operation data number is applied.	-1 to 50 [%]	-1 (Operation data is followed)	A

9.4.1 Softening an impact at starting and stopping

■ "Impact softening filter" parameter

The impact softening filter is a function to perform a filter processing to the set acceleration time and deceleration time, and to suppress an impact being applied to a transferred load at starting or stopping. The motor accelerates slowly at starting and decelerates slowly at stopping.

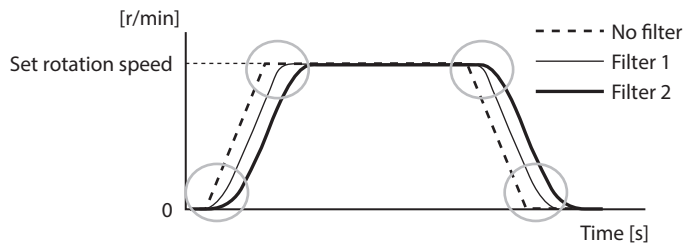

If the "Impact softening filter" is enabled, the actual acceleration time/deceleration time may be longer than the acceleration time/deceleration time having set.

9.4.2 Changing the motor movement at deceleration stop

■ "Deceleration mode selection" parameter

The motor stopping movement can be selected. Set according to the type of a power supply used or the motor stopping movement.

However, note the deceleration stop time varies depending on a load condition.

To stop the motor with the set deceleration time

Not to return the regenerative power to the power supply (switched-mode power supply, etc.)

"Deceleration stop 1"

This is the stopping method that regenerative power generated at deceleration stop is consumed in the motor and driver not to return to the power supply side.

When the deceleration time is short, the output torque may become smaller than the set torque limiting value due to regenerative energy, causing the stopping time to increase.

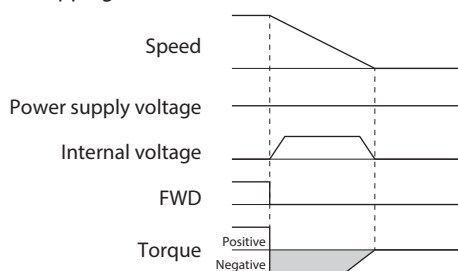

- To utilize the regenerative power
- Regenerative capacity is large (Battery, etc.)

"Deceleration stop 3"

This is the stopping method that regenerative power generated at deceleration stop is returned to the power supply side.

Also, use this setting when regenerative power is used in other equipment.

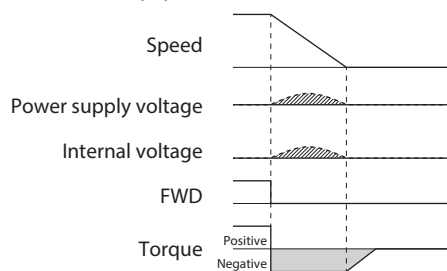

● Note when using a switched-mode power supply in "Deceleration stop 3"
 If a power supply with a small regenerative capacity is combined, the voltage may rise as indicated by hatched areas, causing a trip in the power supply or an alarm of the driver to generate.
 When performing regeneration operation continuously, use a power supply with a large regenerative capacity.

To stop the motor gently

"Deceleration stop 2"

The motor coasts to a stop due to no braking force. If the deceleration time is longer than the coasting stop time, the motor stops according to the deceleration stop time.

9.4.3 Changing the rotation direction when the FWD/REV signal * is turned ON

■ "Motor rotation direction" parameter

Even when a gearhead with a reduction ratio which rotation direction is opposite to the motor output shaft is used, the rotation direction of the gearhead output shaft when the FWD/REV input * is turned ON can be set to the same as that of the motor.

Rotation direction of the motor output shaft ⇒ p.36

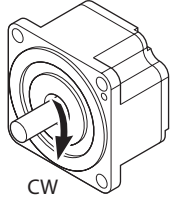
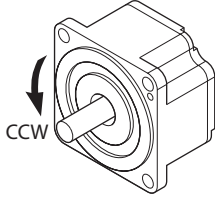
Input signal	Rotation direction when the input signal is turned ON	
	"Motor rotation direction" parameter +=CW	+=CCW
FWD/REV*		

* This is the signal when the 3-wire mode is selected. When the 2-wire mode is selected, it is the FWD input.

9.4.4 Changing the input mode of the operation signal to the 2-wire mode.

■ "Operation input mode selection" parameter

The input mode of the operation signal can be changed from the 3-wire mode to the 2-wire mode.

3-Wire mode

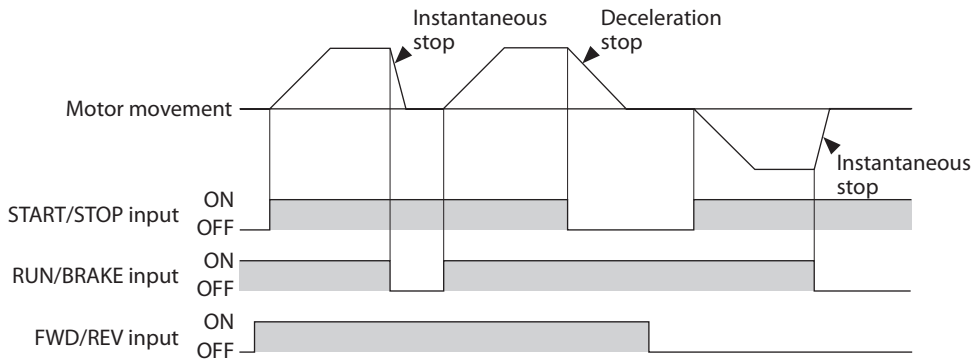

2-Wire mode

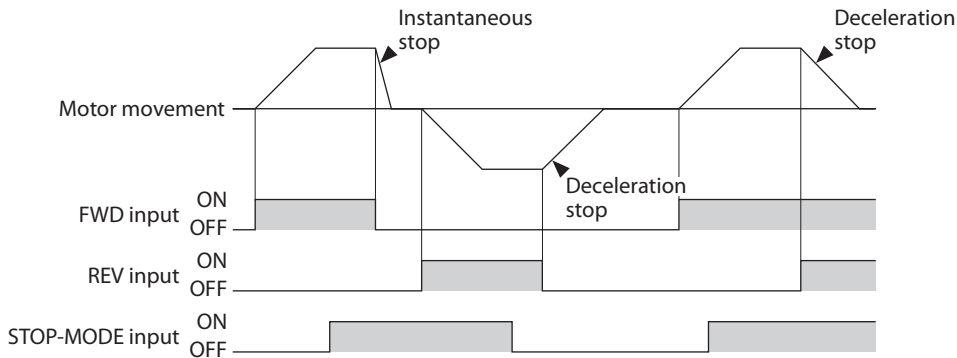

9.4.5 Setting the detection width for the VA output

■ "VA detection width" parameter

The VA output is output when the motor reaches the plus or minus range of the "VA detection width" with respect to the set rotation speed.

The VA detection width can be set in a range of 1 to 400 r/min with respect to the set rotation speed.

(Factory setting: 200 r/min)

Example: When the motor speed changes from the setting speed 1 to the setting speed 2

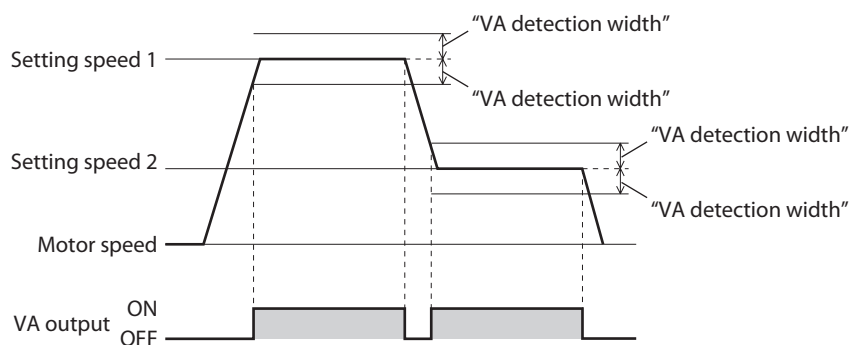

9.4.6 Holding a load at motor standstill (Load holding function)

Although the electromagnetic brake motor can hold a load by the electromagnetic brake when the motor stops, even if a motor without an electromagnetic brake is used, a certain degree of holding force can be generated at motor standstill by the load holding function.

■ "Load holding function selection" parameter

When 1 (enabled) is set, a force to hold the shaft electrically can be generated when the motor stops (load holding torque).

The factory setting is 0 (disable).

If the angle of the motor output shaft is changed about 15°, a holding force is generated.

■ "Load holding torque limiting setting value" parameter

The load holding torque limiting value is set with this parameter.

If -1 is set, the torque limiting value set to the selected operation data number is applied.

When the setting value of the torque limiting value exceeds 50% of the rated torque, the load holding torque is limited to a maximum of 50%.

If a value of 0 to 50% is set, the torque limiting value having set is applied.



- Do not use a motor in a vertical application. If the power supply to the driver is turned off or if an alarm is generated, the holding force is lost. This function cannot be used for keeping the load position when the motor stops.
- If the load holding function is enabled, the time until the motor stops will be longer than when set to disable according to the setting or load conditions. In addition, the motor output shaft may vibrate when the motor stops.

9.5 Alarm and information settings

Refer to p.73 for details about information.

A: Update immediately, C: Update after executing configuration

Parameter name	Description	Setting range	Factory setting	Update
Overload alarm detection time	Sets the detection time of the overload alarm.	0.1 to 10.0 [s]	10.0	A
Prevention of operation at power-on alarm	Sets whether to enable or disable the "prevention of operation at power-on alarm." Refer to p.71 for alarms.	Disable, Enable	Enable	C
Information auto clear	This is a function to clear the information status automatically to turn the INFO output signal OFF when the cause of the generated information was removed.	Disable, Enable	Enable	
Driver temperature information	Sets the generation condition of the driver temperature information.	40 to 85 [°C]	85	
Overvoltage information	Sets the generation condition of the overvoltage information.	18.0 to 38.0 [VDC]	38.0	
Undervoltage information	Sets the generation condition of the undervoltage information.	18.0 to 38.0 [VDC]	18.0	
Load information	Sets the generation condition of the load information.	0 (disable), 1 to 200 [%]	0	
Speed information	Sets the generation condition of the speed information.	0 (disable), 1 to 5200 [r/min]	0	
Tripmeter information	Sets the generation condition of the tripmeter information.	0.0 (disable), 0.1 to 99999999.9 [kRev]	0.0	
Odometer information	Sets the generation condition of the odometer information.	0.0 (disable), 0.1 to 99999999.9 [kRev]	0.0	
Main power supply time information	Sets the generation condition of the main power supply time information.	0 (disable), 1 to 999,999,999 [min]	0	
Main power supply count information	Sets the generation condition of the main power supply count information.	0 (disable), 1 to 999,999,999 [times]	0	
INFO action (Driver temperature information (INFO-DRVTMP))	This is a function to select whether the INFO output will be output and the LED will blink when corresponding information is generated.		INFO action is not applied · Information bit: Indicates on the MEXE02 display · INFO output: OFF · LED: Unlit INFO action is applied · Information bit: Indicates on the MEXE02 display · INFO output: ON · LED: Blink	A
INFO action (Overvoltage information (INFO-OVOLT))				
INFO action (Undervoltage information (INFO-UVOLT))				
INFO action (Load information (INFO-LOAD))				
INFO action (Speed information (INFO-SPD))				
INFO action (Operation data setting error information (INFO-SET-E))				
INFO action (Operation prohibited information (INFO-DRV))				
INFO action (Tripmeter information (INFO-TRIP))				
INFO action (Odometer information (INFO-ODO))				
INFO action (Torque limiting value setting error information (INFO-TRQ-DE))				
INFO action (Rotation speed setting information (INFO-SPD-DE))				
INFO action (Main power supply time information (INFO-PTIME))				
INFO action (Main power supply count information (INFO-PCOUNT))				
INFO action (Operation start limiting mode information (INFO-DSLMTD))				
INFO action (I/O test mode information (INFO-IOTEST))				
INFO action (Configuration request information (INFO-CFG))				
INFO action (Power cycling request information (INFO-RBT))				

9.6 Monitor setting

A: Update immediately

Parameter name	Description	Setting range	Factory setting	Update
Driver user name	The desired name can be given to the driver used. (The set name can be checked using the unit information monitor.)	Up to 16 characters	-	A
Speed reduction ratio	Sets the speed reduction ratio when the rotation speed of the gearhead output shaft is monitored. The speed reduction ratio is calculated by multiplying a value in the "Speed reduction ratio" parameter by that in the "Speed reduction ratio digit setting" parameter. The rotation speed of the gearhead output shaft can be checked on the status monitor of the MEXE02 .	100 to 9999	100	
Speed reduction ratio digit setting		×1, ×0.1, ×0.01	×0.01	
Speed increasing ratio	Sets the speed increasing ratio when the increased rotation speed is monitored. If the speed increasing ratio is set to other than 1, the speed increasing ratio is prioritized. The rotation speed of the gearhead output shaft is shown on the status monitor of the MEXE02 as a value calculated by multiplying a value in the "Speed increasing ratio" parameter by a rotation speed.	1.00 to 2.00	1.00	

■ Calculation method of speed reduction ratio: "Speed reduction ratio" parameter, "Speed reduction ratio digit setting" parameter

Set using the "Speed reduction ratio" parameter and "Speed reduction ratio digit setting" parameter.

To display the rotation speed of the gearhead output shaft on the **MEXE02**

Example) When the speed reduction ratio 15 is set

Set 150 to the "Speed reduction ratio" parameter and ×0.1 to the "Speed reduction ratio digit setting" parameter.

15 that was calculated by the formula "150 × 0.1" was set.

At this time, $\frac{1}{15}$ speed of the motor rotation speed is displayed.

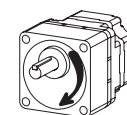

Rotation speed

To display the conveyor transfer speed on the **MEXE02**

To display the conveyor transfer speed, calculate the conveyor speed reduction ratio using the formula below, and set to the "Speed reduction ratio" parameter.

$$\text{Conveyor speed reduction ratio} = \frac{1}{\text{Feed rate per motor revolution}} = \frac{\text{Gearhead gear ratio}}{\text{Pulley diameter [m]} \times \pi}$$

If the calculated conveyor speed reduction ratio is used, the conveyor transfer speed is converted as follows.

$$\text{Conveyor transfer speed [m/min]} = \frac{\text{Rotation speed of motor output shaft [r/min]}}{\text{Conveyor speed reduction ratio}}$$

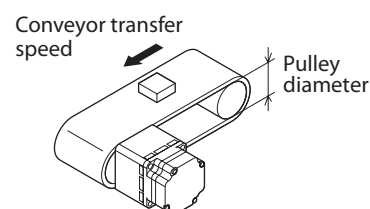

Example) When the pulley diameter is 0.1 m and the gear ratio of the gearhead is 20

$$\text{Conveyor speed reduction ratio} = \frac{\text{Gearhead gear ratio}}{\text{Pulley diameter [m]} \times \pi} = \frac{20}{0.1 \text{ [m]} \times \pi} \approx 63.7$$

From the conversion formula, the conveyor speed reduction ratio is calculated as 63.7 in this example.

If the conveyor speed reduction ratio is 63.7 and the rotation speed of the motor is 1300 r/min, the conveyor transfer speed is converted as follows:

$$\text{Conveyor transfer speed [m/min]} = \frac{1300}{63.7} \approx 20.4$$

[MEXE02 Status monitor window]

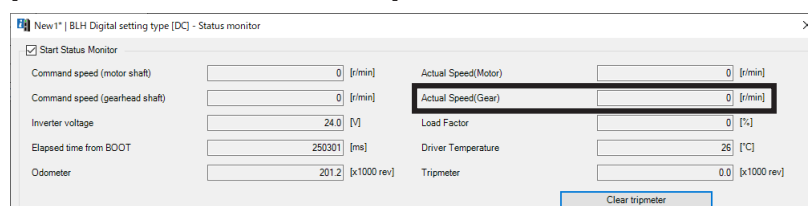

9.7 I/O function selection

C: Update after executing the configuration

Parameter name	Description	Setting range	Factory setting	Update
DIN0 input function selection	Selects the input signal to assign to the direct I/O (DIN0 to DIN5).	Refer to "1 Input function selection."	FWD (START/STOP) *	C
DIN1 input function selection			REV (RUN/BRAKE) *	
DIN2 input function selection			STOP-MODE (FWD/REV) *	
DIN3 input function selection			M0	
DIN4 input function selection			M1	
DIN5 input function selection			ALM-RST	
DIN0 logic level setting	Sets the logic level for the direct I/O (DIN0 to DIN5).	Not invert, Invert	Not invert	
DIN1 logic level setting			Not invert	
DIN2 logic level setting			Not invert	
DIN3 logic level setting			Not invert	
DIN4 logic level setting			Not invert	
DIN5 logic level setting			Not invert	
DOUT0 output function selection	Selects the signal to assign to the direct I/O (DOUT0 to DOUT3).	Refer to "2 Output function selection."	SPEED-OUT	
DOUT1 output function selection			ALM-B	
DOUT2 output function selection			TLC	
DOUT3 output function selection			DIR	
DOUT0 logic level setting	Sets the logic level for the direct I/O (DOUT0 to DOUT3).	Not invert, Invert	Not invert	
DOUT1 logic level setting			Not invert	
DOUT2 logic level setting			Not invert	
DOUT3 logic level setting			Not invert	

* If the 3-wire input mode is selected with the "Operation input mode selection" parameter, the signal in the parentheses () will be applied.

■ Setting range of the function selection parameter

1 Input function selection

Refer to p.22 for details.

Not used	M0	M2
ALM-RST	M1	STOP-MODE (FWD/REV) *
INFO-CLR	EXT-ERROR	H-FREE
HMI	FWD (START/STOP) *	
TL	REV (RUN/BRAKE) *	

* If the 3-wire input mode is selected with the "Operation input mode selection" parameter, the signal in the parentheses () will be applied.

2 Output function selection

Refer to p.25 for details.

Not used	VA	INFO-UVOLT	INFO-TRIP	INFO-PCOUNT
ALM-A	SPEED-OUT	INFO-LOAD	INFO-ODO	INFO-DSLMTD
ALM-B	DIR	INFO-SPD	INFO-TRQ-DE	INFO-IOTEST
MOVE	INFO-DRVTMP	INFO-SET-E	INFO-SPD-DE	INFO-CFG
INFO	INFO-OVOLT	INFO-DRV	INFO-PTIME	INFO-RBT
TLC				

9.8 I/F function

D: Update after turning on the power again

Parameter name	Description	Setting range	Factory setting	Update
USB-ID enable	Sets whether to enable or disable the USB-ID (serial number). When it is set to "Disable," the USB-ID is automatically set to a random number.	Disable, Enable	Enable	D
USB-ID	Sets the USB-ID (serial number). The COM port at power-on can be fixed.	0 to 999,999,999	0	
USB-PID	Sets the ID to be displayed in the COM port.	0 to 31	0	

■ USB-ID

The USB-ID is a parameter to associate the USB port (COM port number) of a PC with the driver. The COM port number is used when setting the communication port with the **MEXE02**.

If multiple drivers are connected to a PC, the PC allocates empty COM ports to the driver in the connected order. If the driver power is turned on again or if the UBS cable is removed and inserted, the allocated COM port numbers may change because the order of connection recognized by the PC is changed.

● When the USB-ID is not set

COM port number	Connection status
1	Connected
2	Connected
3	Empty
4	Connected
5	Empty
6	Empty

← COM port on the driver that the power was supplied first

← COM port on the driver that the power was supplied second

← COM port on the driver that the power was supplied third

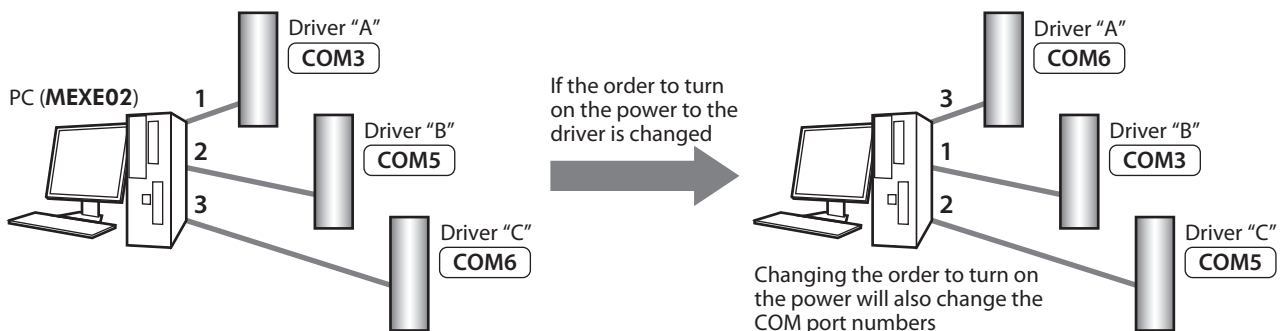

● When the USB-ID is set

If the "USB-ID" parameter is set, the same COM port numbers are always displayed regardless of the order of connection because the COM port number is fixed to each driver. (The USB-ID and the COM port number may not match because a PC associates with empty COM port numbers in descending order.)

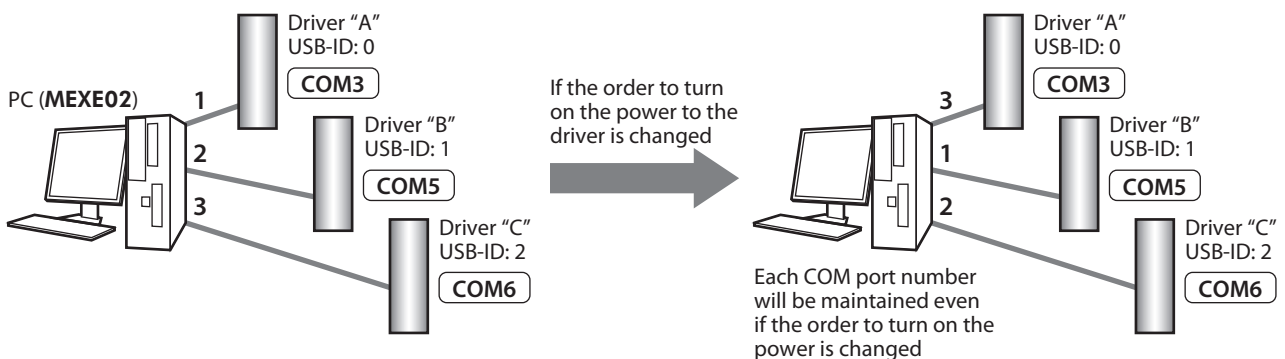

Note

The COM port number set with the "USB-ID" parameter is disabled if the PC is changed.

10 Maintenance and inspection

10.1 Inspection

It is recommended that periodic inspections would be conducted for the items listed below after each operation of the motor.

If an abnormal condition is noted, discontinue any use and contact your nearest Oriental Motor sales office.



- Do not conduct the insulation resistance measurement or dielectric strength test with the motor and driver connected.
Doing so may cause damage to the product.
- The driver uses semiconductor elements, so be extremely careful when handling them.
Static electricity may damage the driver.

■ Inspection item

- Check if any of the mounting screws of the motor and gearhead is loose.
- Check if the bearing part (ball bearings) of the motor generates unusual noises.
- Check if the bearing part (ball bearings) or gear meshing part of the gearhead generates unusual noises.
- Check if the output shaft of the motor and gearhead and a load shaft are out of alignment.
- Check if a damage or stress is applied on the cable or the connection part between the cable and driver is loose.
- Check if dust is deposited on the driver.

10.2 Warranty

Check on the Oriental Motor Website for the product warranty.

10.3 Disposal

Dispose the product correctly in accordance with laws and regulations, or instructions of local governments.

11 Troubleshooting

The motor or driver may not operate properly if the rotation speed is wrongly set or the connection is wrong. If the motor cannot operate properly, refer to the contents provided in this chapter and take appropriate action. If the problem persists, contact your nearest Oriental Motor sales office.



Check the alarm contents when an alarm is generated.

Check the motor movement using teaching/remote operation. If the motor rotates, there may be a mistake occurred either in the setting methods.

I/O signal status and others can be checked using monitors of the **MEXE02**. Use when checking the wiring condition of the I/O signals and others.

The motor does not operate.	<ul style="list-style-type: none"> ● The power supply is not connected correctly or it is improper connection. <ul style="list-style-type: none"> ▷ Check the connection of the power supply.
	<ul style="list-style-type: none"> ● The operation input signal is not turned ON. <ul style="list-style-type: none"> ▷ Check the connection and the ON-OFF status of signal. The signal input status can be checked using the internal I/O monitor or D-I/O monitor.
	<ul style="list-style-type: none"> ● The operation data number is selected wrongly. Or the motor connector is not connected properly. <ul style="list-style-type: none"> ▷ Check the connection and the ON-OFF status of signal. The signal input status can be checked using the internal I/O monitor or D-I/O monitor.
	<ul style="list-style-type: none"> ● An alarm is present. <ul style="list-style-type: none"> ▷ Check if an alarm is generated. The PWR/ALM LED blinks in red while an alarm is present. The alarm content can be checked by counting the number of times the LED blinks or by using the MEXE02. Refer to p.71, and reset the alarm after removing the cause of the alarm.
	<ul style="list-style-type: none"> ● The operation data is set wrongly. <ul style="list-style-type: none"> ▷ Check how to set the operation data. The setting method and setting value of the operation data selected can be checked using the status monitor.
The motor does not move according to the set operation data.	<ul style="list-style-type: none"> ● The operation data number is selected wrongly. Or the motor connector is not connected properly. <ul style="list-style-type: none"> ▷ Check the connection and the ON-OFF status of signal. The signal input status can be checked using the internal I/O monitor or D-I/O monitor.
	<ul style="list-style-type: none"> ● The setting method or setting value is wrong. <ul style="list-style-type: none"> ▷ Check the setting method. The setting method and setting value presently selected can be checked using the status monitor.
	<ul style="list-style-type: none"> ● A load is too large. <ul style="list-style-type: none"> ▷ Check if the torque is enough.
	<ul style="list-style-type: none"> ● An external analog setting device or PWM signal input is set wrongly. <ul style="list-style-type: none"> ▷ Check the setting value of the "External setting method" parameter. The setting of the "External setting method" parameter can be checked using the unit information monitor.
The rotation speed cannot be increased.	<ul style="list-style-type: none"> ● The rotation speed equal to or higher than the value set in the "Speed upper limit" parameter is set. <ul style="list-style-type: none"> ▷ Reconsider the setting value of the "Speed upper limit" parameter or operation data.
The rotation speed cannot be decreased.	<ul style="list-style-type: none"> ● The rotation speed lower than the value set in the "Speed lower limit" parameter is set. <ul style="list-style-type: none"> ▷ Reconsider the setting value of the "Speed lower limit" parameter or operation data.

<ul style="list-style-type: none"> • A time for stopping is long. • The stopping method is wrong. 	<ul style="list-style-type: none"> ● The stopping method is wrongly selected. <ul style="list-style-type: none"> ▷ Check the stopping method. In the case of the 3-wire mode of the operation input mode, the stop movement by turning the RUN/BRAKE input OFF is different from that by turning the START/STOP input OFF. In the case of the 2-wire mode of the operation input mode, the stop movement when the STOP-MODE input is ON is different from that when it is OFF. Refer to p.23 and p.62 for details. ▷ For the deceleration stop, check the setting value of the "Deceleration mode selection" parameter. Check the setting value of the parameter using the unit information monitor. ● Load inertia is too large. <ul style="list-style-type: none"> ▷ Check by increasing the frictional load or reducing the load inertia.
<p>Torque limiting value is not increased.</p>	<ul style="list-style-type: none"> ● The value set in the "Torque limiting maximum value" parameter is exceeded. <ul style="list-style-type: none"> ▷ Reconsider the setting value of the "Torque limiting maximum value" parameter or operation data.
<p>Torque cannot be limited.</p>	<ul style="list-style-type: none"> ● If the TL input is turned OFF, the torque limiting function is disabled. <ul style="list-style-type: none"> ▷ Check the connection and the ON-OFF status of signal. The signal input status can be checked using the internal I/O monitor or D-I/O monitor.
<p>The PWR/ALM LED blinks in orange.</p>	<ul style="list-style-type: none"> ● Information is present. <ul style="list-style-type: none"> ▷ Information is present because of any of the causes. Check the generated information using the information monitor or internal I/O monitor, and clear the cause of generation or disable the "INFO action" parameter.
<p>The motor rotates in the opposite direction to the specified one.</p>	<ul style="list-style-type: none"> ● The ON-OFF operation of the FWD/REV input is used wrongly or the FWD/REV input is not connected correctly. <ul style="list-style-type: none"> ▷ Check the connection and the ON-OFF status of signal. The signal input status can be checked using the internal I/O monitor or D-I/O monitor. ● The setting of the "Motor rotation direction" parameter has been changed. <ul style="list-style-type: none"> ▷ The motor rotates in the forward direction when the FWD/REV input is turned ON. The setting for rotating in the forward direction can be set with the "Motor rotation direction" parameter. (Initial value: +=CW) ● The gearhead with a reduction ratio which rotation direction is opposite to the motor output shaft is used. (Refer to p.36 for the rotation direction of the gearhead output shaft) <ul style="list-style-type: none"> ▷ Reverse the ON-OFF status of the FWD/REV input or invert the logic level setting of the input. Change the setting for the "Motor rotation direction" parameter. ● A hollow shaft flat gearhead is used. <ul style="list-style-type: none"> ▷ The hollow shaft flat gearhead rotates in the opposite direction to the motor when viewed from the front side of the gearhead, and rotates in the same direction to the motor when viewed from the rear side (motor mounting side).
<ul style="list-style-type: none"> • The motor movement is not stable. • Motor vibration is too large. 	<ul style="list-style-type: none"> ● The motor and gearhead output shaft and a load shaft are out of alignment. <ul style="list-style-type: none"> ▷ Check the coupling condition of the motor and gearhead output shaft and the load shaft. ● The motor output power and the driver output power are not matched. <ul style="list-style-type: none"> ▷ Check if the motor output power and the driver output power are the same. The driver output power can be checked by the driver model name in the unit information monitor. ● The product is affected by electrical noise. <ul style="list-style-type: none"> ▷ Check the operation using the motor, driver and a minimum of external equipment required for operation. If an effect of noise has been confirmed, implement the following countermeasures: [Keep away from the noise sources.] [Reconsider the wiring.]

12 Alarms

This driver has the alarm function to protect from temperature rise, poor connection, error in operation, and others. If an alarm is generated, the ALM-A output is turned ON (in the case of normally open), or the ALM-B output is turned OFF (in the case of normally closed). At the same time, the motor stops, and the PWR/ALM LED blinks in red.

The generated alarm content can be checked by counting the number of times the LED blinks or by using the **MEXE02**.

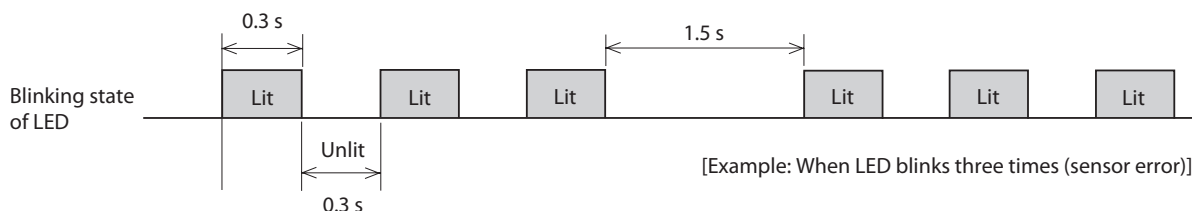

12.1 Alarm reset

Before resetting an alarm by one of the following methods, be sure to remove the cause of the alarm and ensure safety.

- Turn the ALM-RST input ON. (The alarm will be reset at the ON edge of the input.)
- Turn on the power again.
- Execute the alarm reset using the **MEXE02**.



- Some alarms cannot be reset other than turning on the power again. Refer to "12.3 Alarm lists" on the next page.
- Continuing the operation without removing the cause of the alarm may cause damage to equipment.
- Operation cannot be performed until the alarm is reset.
- Perform the ALARM-RESET input after the motor (gearhead) output shaft is stopped completely.

Turn the operation input signal OFF, and remove the cause of the alarm before resetting the alarm.

The alarm reset is disabled while the operation input signal is being ON.

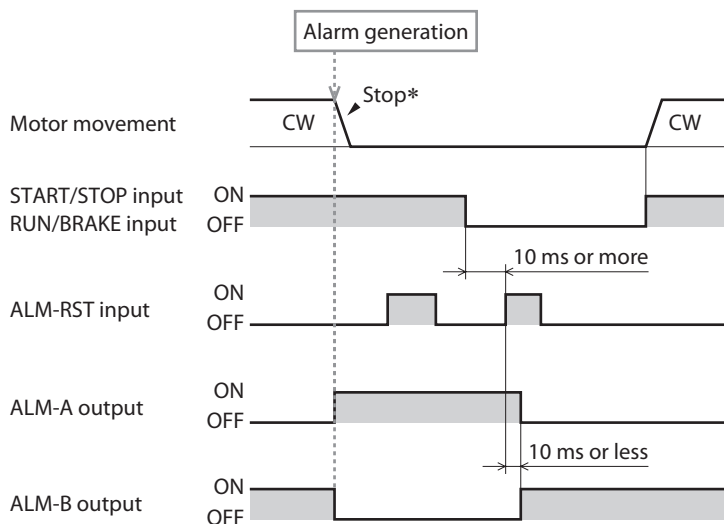

* If an alarm is generated while the motor rotates, the motor will coast to a stop.

12.2 Alarm history

Up to 10 generated alarms are saved in the non-volatile memory in order of the latest to oldest.

Exceeding 10 alarm records will overwrite the data in order from the oldest recorded data.

Alarm history is not cleared even if the power is shut off.

The alarm history and the driver status when an alarm is generated can be checked using the **MEXE02**.

12.3 Alarm lists

Number of times PWR/ALM LED blinks	Alarm name	Cause	Remedial action	Reset using the ALM-RST input	
Two times	Overload	A load exceeding the rated torque was applied to the motor for a time set in the "Overload alarm detection time" parameter or more. *	<ul style="list-style-type: none"> Decrease a load. Reconsider operating conditions such as the acceleration time and deceleration time. If the alarm is generated at a low temperature, warm up. 	Possible	
Three times	Sensor error	The sensor line in the motor cable was disconnected. Or the motor cable was come off.	Check the connection between the driver and motor.		
	Sensor error at power-on	The sensor line in the motor cable was disconnected. Or the driver power supply was turned on in a state where the motor cable was come off.			
Four times	Overvoltage	<ul style="list-style-type: none"> The internal voltage of the driver exceeded 38 VDC. A large inertial load was suddenly stopped. 	<ul style="list-style-type: none"> Check the power supply voltage. If the alarm is generated during operation, decrease a load or increase the deceleration time. If the motor is rotated by external force, reconsider how to use or environment. 		
Five times	Undervoltage	The internal voltage of the driver dropped below 18 VDC.	<ul style="list-style-type: none"> Check the power supply voltage. Check the wiring of the power supply cable. 		
Six times	Overspeed	The motor rotation speed was exceeded 5200 r/min.	<ul style="list-style-type: none"> Decrease a load. Reconsider operating conditions such as the acceleration time and deceleration time. If the motor is rotated by external force, reconsider how to use or environment. 		
Seven times	Overcurrent	Excessive current was flown through the driver due to ground fault, etc.	Turn off the power, and turn on the power again after checking if the product is not damaged. If the alarm is not cleared, contact your nearest Oriental Motor sales office.		Not possible
Eight times	EEPROM error	The data stored in the driver was damaged.	Initialize the parameters, and turn on the power again.		
Nine times	Main circuit overheat	The internal temperature of the driver exceeded 85°C (185°F).	<ul style="list-style-type: none"> Reconsider the ambient temperature. Reconsider the ventilation condition. Reconsider the operating condition. 		Possible
10 times	External stop	<ul style="list-style-type: none"> The EXT-ERROR input signal was turned OFF. External stop was executed using the MEXE02. 	Check the EXT-ERROR input signal.		
11 times	Prevention of operation at power-on	The power supply was turned on in a state where the "Prevention of operation at power-on alarm" parameter was set to "enable" and the operation input signal was being ON.	Before supplying power to the driver, turn the operation input signal OFF.		
Lit	CPU error	The CPU is not operated properly.	Turn on the power again. If the alarm is not cleared, contact your nearest Oriental Motor sales office.	Not possible	

* The setting can be changed using the "Overload alarm detection time" parameter. Refer to p.64 for details.

13 Information

The driver is equipped with a function to generate information output before an alarm is generated. This function can be utilized for periodic maintenance of equipment by setting a suitable value in the parameter of each information.

Set and check using the information monitor of the **MEXE02**.

■ Status when information is generated

● Information bit output

If information is generated, a bit output (INFO-** output) of the corresponding information is turned ON. The bit output can be checked using the internal I/O monitor and waveform monitor of the **MEXE02**.

● INFO output

If any of information is generated, the INFO output will be turned ON.

● LED indicator

If information is generated, the PWR/ALM LED will blink in orange.

● Motor operation

The motor continues to operate during information unlike in the case of an alarm.

● Parameter

Conditions of the cause of generation for some information can be adjusted by parameter setting.

Each information has a corresponding "INFO action" parameter. If the parameter is set to "Not reflected (Only bit output turned ON)," only the bit output of information is turned ON, and the INFO output and LED are not changed.

Also, by setting the "Information auto clear" parameter, you can select whether the INFO output or the bit output of the corresponding information is automatically turned OFF when information is cleared.

13.1 Information history

Up to 16 generated information are saved in the RAM in order of the latest to oldest.

The information items stored as information history are the information code, generation time, and contents of information.

The stored information history can be checked using the **MEXE02**.



Information history will be cleared if the power supply of the driver is turned OFF.

13.2 Information lists

The driver status can be checked using the unit information monitor or the status monitor of the **MEXE02**.

Information	Information bit output signal	Cause	Condition to reset and clear
Driver temperature	INFO-DRVTMP	The internal temperature of the driver increased to the setting value of the "Driver temperature information" parameter or higher.	The internal temperature of the driver dropped below the setting value of the "Driver temperature information" parameter.
Overvoltage	INFO-OVOLT	The internal voltage of the driver increased to the setting value of the "Overvoltage information" parameter or higher.	The internal voltage of the driver dropped below the setting value of the "Overvoltage information" parameter.
Undervoltage	INFO-UVOLT	The internal voltage of the driver dropped to the setting value of the "Undervoltage information" parameter or lower.	The internal voltage of the driver exceeded the setting value of the "Undervoltage information" parameter.
Load	INFO-LOAD	The detected torque of the motor increased to the setting value of the "Load information" parameter or higher.	The detected torque of the motor dropped below the setting value of the "Load information" parameter.
Speed	INFO-SPD	The detected speed of the motor increased to the setting value of the "Speed information" parameter or higher.	The detected speed of the motor dropped below the setting value of the "Speed information" parameter.
Operation data setting error	INFO-SET-E	For the setting method of operation data, the same setting method is assigned in the same operation data number. Setting method ⇒ p.29	The setting method of the operation data number that the same setting method had been assigned was set again.
Operation prohibited	INFO-DRV	<ul style="list-style-type: none"> ● The operation input signal is being ON when I/O test of the MEXE02 or teaching/remote operation was complete. ● Configuration was executed in a state where the motor would immediately rotate when the assignment or the logic level setting of input terminals was changed. ● The operation data number that the same setting method was assigned was selected to operate. Setting method ⇒ p.29 	<ul style="list-style-type: none"> ● The operation input signal was turned OFF. ● The setting method of the operation data number that the same setting method had been assigned was set again. ● The selected operation data number was changed.
Tripmeter *	INFO-TRIP	The rotation amount inside the driver increased to the setting value of the "Tripmeter information" parameter or more.	<p>One of the following operations was performed, and the rotation amount inside the driver dropped below the setting value of the "Tripmeter information" parameter.</p> <ul style="list-style-type: none"> ● The "Tripmeter information" parameter was set again. ● Tripmeter was cleared using the MEXE02.
Odometer *	INFO-ODO	The integrated rotation amount inside the driver increased to the setting value of the "Odometer information" parameter or more.	The "Odometer information" parameter was set again, and the integrated rotation amount inside the driver dropped below the setting value of the "Odometer information" parameter.

* The tripmeter and odometer are saved in the non-volatile memory in the driver at intervals of one minute.
If the power supply is shut off before saving in the driver, the travel distance for one minute is not applied.

Information	Information bit output signal	Cause	Condition to reset and clear
Torque limiting value setting error	INFO-TRQ-DE	A value exceeding the "Torque limiting maximum value" parameter was set in the torque limiting value of the operation data.	<ul style="list-style-type: none"> ● A value lower than the "Torque limiting maximum value" parameter was set again in the torque limiting value of the operation data. ● A value exceeding the torque limiting value of the operation data was set again in the "Torque limiting maximum value" parameter.
Rotation speed setting error	INFO-SPD-DE	A value outside a range of the "Speed upper limit" parameter and "Speed lower limit" parameter was set in the rotation speed of the operation data.	<ul style="list-style-type: none"> ● A value in a range of the "Speed upper limit" parameter and "Speed lower limit" parameter was set again in the rotation speed of the operation data. ● A value was set again in the "Speed upper limit" parameter or/and "Speed lower limit" parameter so that the rotation speed of the operation data was in a range of the parameters.
Main power supply time	INFO-PTIME	A time period having supplied the power to the main power supply of the driver increased to the setting value of the "Main power supply time information" parameter or more.	The "Main power supply time information" parameter was set again, and the time period having supplied the power to the main power supply of the driver dropped below the setting value of the "Main power supply time information" parameter.
Main power supply count	INFO-PCOUNT	The number of times for turning on the main power supply of the driver increased to the setting value of the "Main power supply count information" parameter or more.	The "Main power supply count information" parameter was set again, and the number of times for turning on the main power supply of the driver dropped below the setting value of the "Main power supply count information" parameter.
Operation start limit mode	INFO-DSLMTD	<ul style="list-style-type: none"> ● Configuration was executed. ● "Teaching/remote operation" was executed using the MEXE02. ● Writing was performed using the MEXE02. ● "Restored to the factory setting" was executed using the MEXE02. 	<ul style="list-style-type: none"> ● Configuration was complete. ● "Teaching/remote operation" was released. ● "Restored to the factory setting" was complete.
I/O test mode	INFO-IOTEST	<ul style="list-style-type: none"> ● "I/O test" was executed using the MEXE02. ● Configuration was executed. 	<ul style="list-style-type: none"> ● "I/O test" was released. ● Configuration was complete.
Configuration request	INFO-CFG	● The parameter change required configuration was executed.	Configuration was executed.
Power cycling request	INFO-RBT	The parameter change required to turn on the driver power again was executed.	Turning on the driver power again was executed.

14 Specifications

14.1 Specifications

Values in the rated torque, peak torque, rated rotation speed, and speed control range represent those in a state where the gearhead is not combined. For details about the motor, refer to the operating manual of the motor.

Check on the Oriental Motor Website for the product specifications.

■ 15 W

Model	Driver	BLH2D15-KD	BLH2D15H-KD
	Motor	BLHM015	BLM015HK
Rated output power (Continuous)		15 W	
Power supply input	Rated voltage	24 VDC	
	Permissible voltage range	-10 to +10%	
	Rated input current	0.93 A	0.96 A
	Maximum input current	2.3 A	2.5 A
Rated torque		0.048 N·m (6.8 oz-in)	
Peak torque		0.072 N·m (10.2 oz-in)	
Rated rotation speed		3000 r/min	
Speed control range		(80 *) 100 to 3000 r/min	

* Digital setting

■ 30 W

Model	Driver	BLH2D30-KD	BLH2D30DH-KD	BLH2D30H-KD
	Motor	BLHM230	BLM030DHK	BLM230HK
Rated output power (Continuous)		30 W		
Power supply input	Rated voltage	24 VDC		
	Permissible voltage range	-10 to +10%		
	Rated input current	1.9 A	1.8 A	
	Maximum input current	4.1 A	4.4 A	3.9 A
Rated torque		0.115 N·m (16.3 oz-in)	0.096 N·m (13.6 oz-in)	0.115 N·m (16.3 oz-in)
Peak torque		0.173 N·m (24 oz-in)	0.144 N·m (20 oz-in)	0.173 N·m (24 oz-in)
Rated rotation speed		2500 r/min	3000 r/min	2500 r/min
Speed control range		(80 *) 100 to 3000 r/min		

* Digital setting

■ 50 W

Model	Driver	BLH2D50-KD	BLH2D50DH-KD	BLH2D50H-KD
	Motor	BLHM450	BLM250DHK	BLM450HK
Rated output power (Continuous)		50 W		
Power supply input	Rated voltage	24 VDC		
	Permissible voltage range	-10 to +10%		
	Rated input current	2.9 A		
	Maximum input current	5.4 A	5.8 A	5.9 A
Rated torque		0.191 N·m (27 oz-in)		
Peak torque		0.287 N·m (40 oz-in)		
Rated rotation speed		2500 r/min		
Speed control range		(80 *) 100 to 3000 r/min		

* Digital setting

14.2 General specifications

Operating environment	Ambient temperature	Driver: 0 to +50 °C [+32 to +122 °F] (non-freezing)
	Ambient humidity	85% or less (non-condensing)
	Altitude	Up to 1000 m (3300 ft.) above sea level
	Surrounding atmosphere	No corrosive gas, dust, water or oil. Cannot be used in radioactive materials, magnetic field, vacuum or other special environment. (For details about installation locations, refer to p.9.)
Storage environment Shipping environment	Vibration	Not subject to continuous vibrations or excessive impact. In conformance with JIS C 60068-2-6 "Sine-wave vibration test method" Frequency range: 10 to 55 Hz Pulsating amplitude: 0.15 mm (0.006 in.) Sweep direction: 3 directions (X, Y, Z) Number of sweeps: 20 times
	Ambient temperature	Driver: -25 to +70 °C [-13 to +158 °F] (non-freezing)
Storage environment Shipping environment	Ambient humidity	85% or less (non-condensing)
	Altitude	Up to 3000 m (10000 ft.) above sea level
Storage environment Shipping environment	Surrounding atmosphere	No corrosive gas, dust, water or oil. Cannot be used in radioactive materials, magnetic field, vacuum or other special environment.
	Degree of protection	IP00

14.3 Dimension

Mass: 46 g (1.62 oz.)

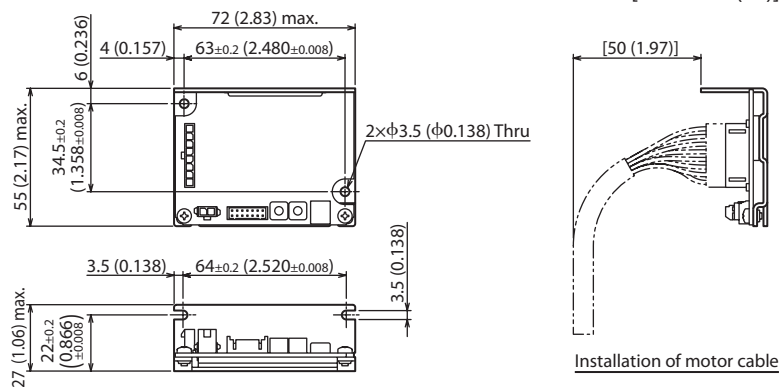

15 Regulations and standards

15.1 UL Standards and CSA Standards

Some products are recognized by UL under the UL/CSA standards.

Model	Applicable Standards	Certification Body	Standards File No.
BLH2D15-KD, BLH2D30-KD, BLH2D50-KD	UL 62368-1 CSA C22.2 No.62368-1	UL	E208200
BLH2D15H-KD, BLH2D30H-KD, BLH2D50H-KD, BLH2D30DH-KD, BLH2D50DH-KD	—	—	—

15.2 EU Directives

■ CE Marking

This product is affixed the CE Marking under the EMC Directive.

● Low Voltage Directives

- This product is not subject to the coverage of the Low Voltage Directive because the input power supply voltage is 24 VDC.
- When conforming the equipment incorporating this product to the Low Voltage Directive, connect the driver power supply input to the DC power supply where the primary and secondary sides are provided with reinforced insulation.
- Install this product inside an enclosure because it is designed and manufactured to be incorporated in equipment.
- Degree of protection for driver: IP00

● EMC Directive

This product has received EMC compliance under the conditions specified in "Example of installation and wiring" on p.19. The final level of conformance of your mechanical equipment to the EMC Directive will vary depending on such factors as the control system equipment used with the motor and driver, configuration of electrical parts, wiring, layout, and hazard level. It therefore must be verified through conducting EMC measures on your mechanical equipment.

Applicable standards

EMI	EN 55011 Group 1 Class A EN 61000-6-4
EMS	EN 61000-6-2

Caution This equipment is not intended for use in residential environments nor for use on a low-voltage public network supplied in residential premises, and it may not provide adequate protection to radio reception interference in such environments.

15.3 Republic of Korea, Radio Waves Act

KC Mark is affixed to this product under the Radio Waves Act, the republic of Korea.

15.4 RoHS Directive

The products do not contain the substances exceeding the restriction values of RoHS Directive (2011/65/EU).

- Unauthorized reproduction or copying of all or part of this manual is prohibited.
If a new copy is required to replace an original manual that has been damaged or lost, please contact your nearest Oriental Motor branch or sales office.
- Oriental Motor shall not be liable whatsoever for any problems relating to industrial property rights arising from use of any information, circuit, equipment or device provided or referenced in this manual.
- Characteristics, specifications and dimensions are subject to change without notice.
- While we make every effort to offer accurate information in the manual, we welcome your input. Should you find unclear descriptions, errors or omissions, please contact the nearest office.
- **Orientalmotor** is a registered trademark or trademark of Oriental Motor Co., Ltd., in Japan and other countries.
Other product names and company names mentioned in this manual may be registered trademarks or trademarks of their respective companies and are hereby acknowledged. The third-party products mentioned in this manual are recommended products, and references to their names shall not be construed as any form of performance guarantee. Oriental Motor is not liable whatsoever for the performance of these third-party products.

© Copyright ORIENTAL MOTOR CO., LTD. 2018

Published in March 2021

- Please contact your nearest Oriental Motor office for further information.

ORIENTAL MOTOR U.S.A. CORP.
Technical Support Tel:800-468-3982
8:30am EST to 5:00pm PST (M-F)
www.orientalmotor.com

ORIENTAL MOTOR (EUROPA) GmbH
Schiessstraße 44, 40549 Düsseldorf, Germany
Technical Support Tel:00 800/22 55 66 22
www.orientalmotor.de

ORIENTAL MOTOR (UK) LTD.
Tel:+44-1256347090
www.oriental-motor.co.uk

ORIENTAL MOTOR (FRANCE) SARL
Tel:+33-1 47 86 97 50
www.orientalmotor.fr

ORIENTAL MOTOR ITALIA s.r.l.
Tel:+39-02-93906347
www.orientalmotor.it

ORIENTAL MOTOR ASIA PACIFIC PTE. LTD.
Singapore
Tel:1800-842-0280
www.orientalmotor.com.sg

ORIENTAL MOTOR (MALAYSIA) SDN. BHD.
Tel:1800-806-161
www.orientalmotor.com.my

ORIENTAL MOTOR (THAILAND) CO., LTD.
Tel:1800-888-881
www.orientalmotor.co.th

ORIENTAL MOTOR (INDIA) PVT. LTD.
Tel:1800-120-1995 (For English)
1800-121-4149 (For Hindi)
www.orientalmotor.co.in

TAIWAN ORIENTAL MOTOR CO., LTD.
Tel:0800-060708
www.orientalmotor.com.tw

SHANGHAI ORIENTAL MOTOR CO., LTD.
Tel:400-820-6516
www.orientalmotor.com.cn

INA ORIENTAL MOTOR CO., LTD.
Korea
Tel:080-777-2042
www.inaom.co.kr

ORIENTAL MOTOR CO., LTD.
4-8-1 Higashiueno, Taito-ku, Tokyo
110-8536 Japan
Tel:+81-3-6744-0361
www.orientalmotor.co.jp