

2-Phase Stepping Motors PK Series

● Connection Information ●
 Technical reference → Page G-1
 Safety standards → Page H-2

28 mm

42 mm

50 mm

56.4 mm

60 mm

85 mm

90 mm

In 2-Phase **PK** Series, in addition to a standard type with a resolution of 200 steps per revolution ($1.8^\circ/\text{step}$), a high-resolution type (Resolution: 400 steps per revolution) and a geared type (high torque, higher resolution) are also available. The dedicated driver is required separately to operate the motor.

RoHS

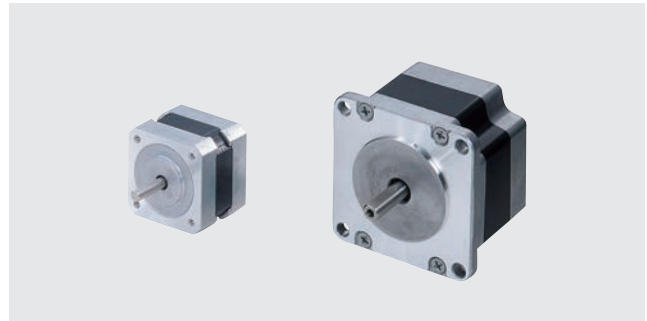

Features

● Wide Variety

A high-resolution type, high-torque, high-efficiency type, high-torque type, standard type, standard type with terminal box and **SH** geared type are also available.

◇ High-Resolution Type

The basic step angle is 0.9° , which is half that of the standard type. 400 steps per rotation is possible. This motor achieves high resolution, improved stopping accuracy and low vibration.

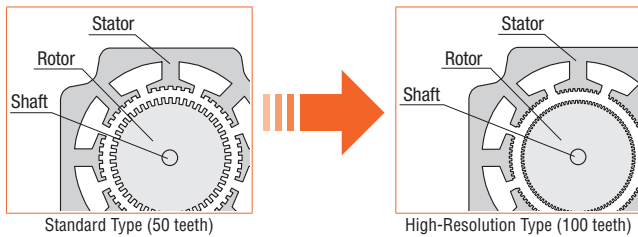

The small basic step angle allows the torque to increase sharply while minimizing the negative effect of frictional load.

Comparison of Angle – Torque Characteristics

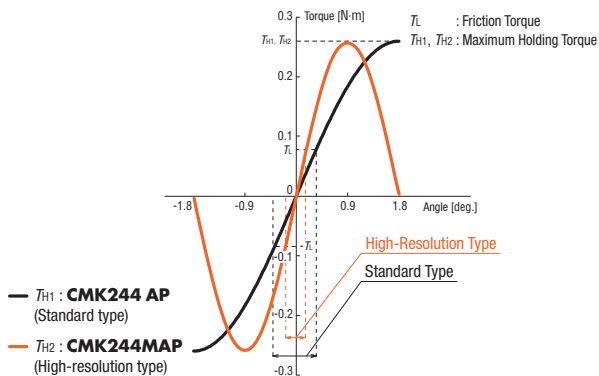

● Avoidance of Resonance Regions

If the used pulse speed is within a resonance region, vibration can increase. Resonance regions can be avoided by switching to a high-resolution type.

◇ High-Torque, High-Efficiency Type

● Lower Heat Generation

Utilizing the latest in motor technology, the high-torque, high-efficiency type stepping motors are able to achieve a significant reduction in the amount of heat generated from the motor. (There is a 50% reduction in temperature rise compared with conventional models.)

Motor Case Temperature under the Same Operating Conditions

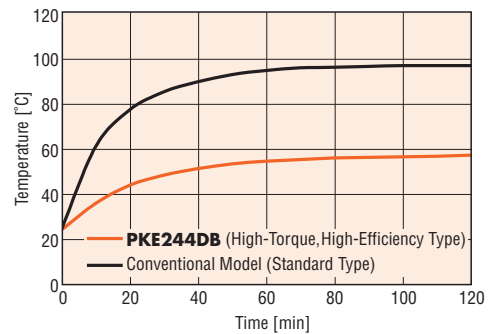

Temperature Distribution by Thermography

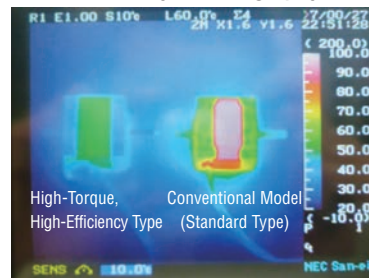

● Comparison under the Same Operating Conditions

● Lower Power Consumption

This model has achieved a 31% reduction* in power consumption through energy savings and a reduction of 10 kg/per year in CO₂ emissions.

Power Consumption

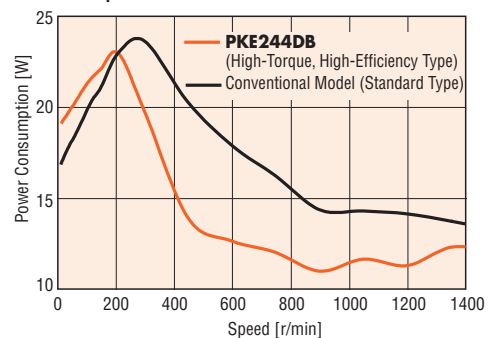

*450 r/min, continuous operation

◇ High-Torque Type

The high-torque type provides, on average, 1.5 times higher torque than a standard stepping motor. By utilizing a larger rotor diameter, larger magnets can be used to significantly increase the output torque.

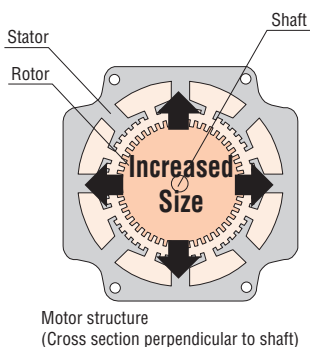

◇ Standard Type

The basic model offers an optimal balance of torque, low vibration and noise reduction.

◇ Standard Type with Cable

The motor conforms to the IP54 standard to changing the lead wire outlet form lead wire to cable and cable clamp (excluding the mounting surface.)

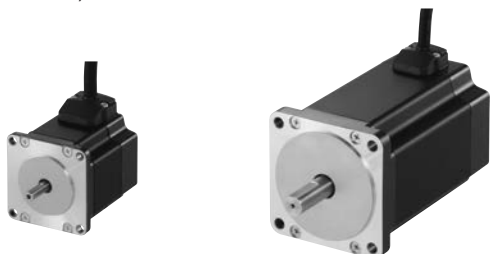

◇ Standard Type with Terminal Box

Terminal boxes have excellent watertightness and dust-resistance. This product conforms to the IP65 motor specification for the degree of protection (excluding shaft penetration).

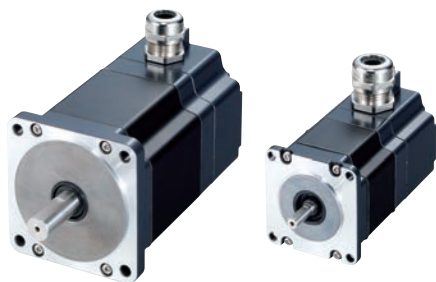

● Terminal-Block Connection Design

The motor can be wired directly from its terminal block.

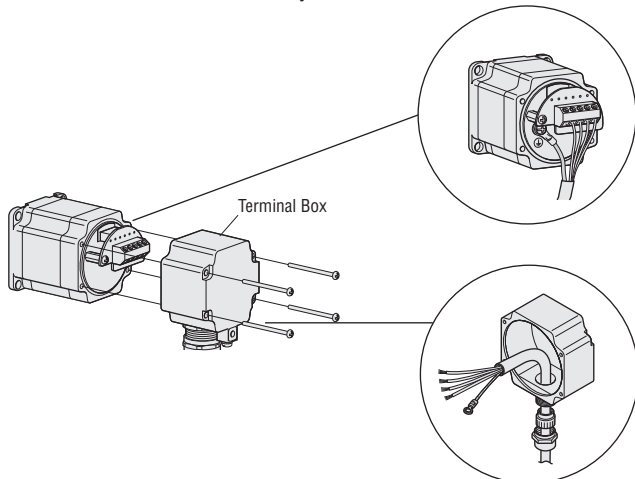

● No Motor/Driver Relay

Since the motor cable can be connected directly to the driver terminals, there is no need for wire connection or soldering on a relay terminal block.

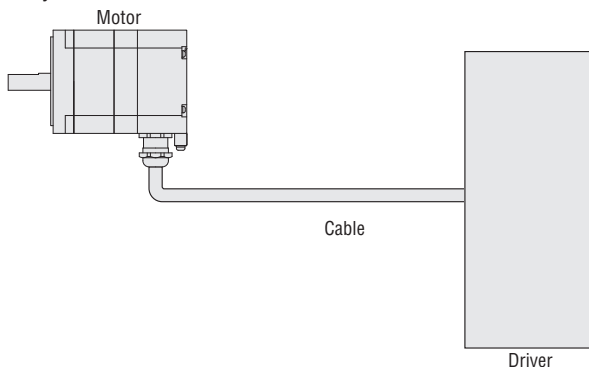





◇ SH Geared Type

This geared type is effective for reducing speed, increasing torque, higher resolution and low vibration. Eight types of gear ratios are available.

Introduction	
AC Input Motor & Driver	
0.36°/Geared AR Q ₅₀₀₀	0.72°/Geared RK
0.36°/Geared AR Q ₅₀₀₀	
DC Input Motor & Driver	
0.36°/0.72°/Geared CRK	1.8°/Geared RBK
0.9°/1.8°/Geared CMK	
Motor Only	
0.72° PK	1.8°/Geared High-Torque PK
0.9°/1.8°/Geared PK	
Controllers SG80301Y	
Accessories	

Motor Lineup

Type	Features	Frame Size			
		28 mm	42 mm	50 mm	56.4 mm
High-Resolution Type	These have half the basic step angle of the standard type, increasing resolution and stopping accuracy.		 Page A-286, A-287		 Page A-291, A-293
High-Torque, High-Efficiency Type	It achieves lower heat generation and lower power consumption with high-efficiency technology. It uses a high-torque designed motor.		 Page A-297, A-298		
High-Torque Type	A high-torque motor generates higher torque of more than 1.5 times compared with the conventional standard type motor.				
Standard Type	These are standard type motors with a wide variety of current specifications.		 Page A-303, A-304	 Page A-308	 Page A-309, A-311
SH Geared Type	These are effective for deceleration, increased torque, increased resolution, and vibration suppression. They have a wide variety of gear ratios.		 Page A-323		
TH Geared Type	A geared motor achieving both low backlash and low cost.		 Page A-327, A-328		
PL Geared Type PS Geared Type	A geared stepping motor with planetary gear mechanism offering low backlash, high strength.	 Page A-331	 Page A-332		

60 mm	85 (90) mm	With Encoder	With Cable	With Terminal Box	Connection Type	
					Bipolar	Unipolar
		 Page A-288, A-294	-	-	●	●
		-	-	-	●	●
 Page A-300, A-301		-	-	-	●	●
	 Page A-315, A-316	 Page A-305, A-312	 Page A-318, A-319	 Page A-320, A-321	● (Except for frame size 50 mm)	●
 Page A-324	 Page A-325	-	-	-	-	●
 Page A-329, A-330		-	-	-	●	●
 Page A-333		-	-	-	●	-

Introduction

0.36°/Geared
AC Input Motor & Driver
AR
0.72°/Geared
RK

0.36°/Geared
AR

0.36°/0.72°/
Geared
DC Input Motor & Driver
CRK
1.8°/Geared
RBK

0.9°/1.8°/Geared
CMK

0.72°
PK

1.8°/Geared
High-Torque
Motor Only
PKP

0.9°/1.8°/Geared
PK

Controllers
SG8030JY

Accessories

System Configuration

These accessories enable 2-phase **PK** Series products to be used for various operations.

* Not supplied

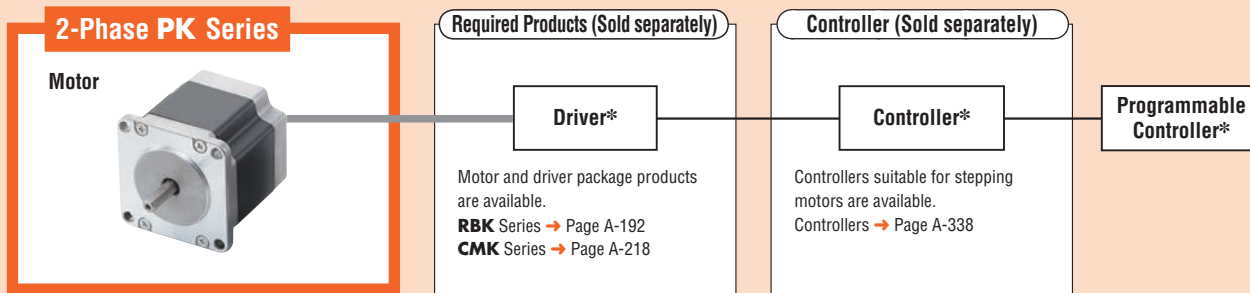

Number	Name	Overview
①	Motor Mounting Brackets	Dedicated mounting bracket for the motor.
②	Flexible Couplings	Coupling that connects the motor shaft to the driven shaft.
③	Clean Dampers	Dedicated damper for suppressing stepping motor vibration.

System Configuration Example



The system configuration shown above is an example. Other combinations are available.

Product Number Code

High-Torque, High-Efficiency Type

PKE 2 4 3 D B - L

① ② ③ ④ ⑤ ⑥ ⑦

①	Series Name	PKE: PK Series High-Torque, High-Efficiency Type
②	2-Phase	
③	Motor Frame Size	4: 42 mm
④	Motor Case Length	
⑤	Number of Lead Wires	Blank: 6 D: 4
⑥	Motor Shaft Type	A: Single Shaft B: Double Shaft
⑦	Connection Cable	L: Included (0.6 m)

High-Torque Type

PK 2 6 4 J D B

① ② ③ ④ ⑤ ⑥ ⑦

①	Series Name	PK: PK Series
②	2-Phase	
③	Motor Frame Size	6: 60 mm
④	Motor Case Length	
⑤	Motor Type	J: High-Torque Type
⑥	Number of Lead Wires	Blank: 6 D: 4
⑦	Motor Shaft Type	A: Single Shaft B: Double Shaft

● Standard Type with Cable
Standard Type with Terminal Box

PK 2 9 6 E A T

① ② ③ ④ ⑤ ⑥ ⑦

● Standard Type (Bipolar 4 lead wires)

PK 2 4 4 D A

① ② ③ ④ ⑤ ⑦

PK 2 6 4 D 14 A

① ② ③ ④ ⑤ ⑥ ⑦

● High-Resolution Type, Standard Type

PK 2 6 6 M - 0 1 B

① ② ③ ④ ⑤ ⑥ ⑦ ⑧

● High-Resolution Type with Encoder
Standard Type with Encoder

PK 2 6 6 M - 0 1 A R22 - L

① ② ③ ④ ⑤ ⑥ ⑦ ⑧ ⑨ ⑩

● Geared Type

PK 2 6 4 A E - SG 10

① ② ③ ④ ⑦ ⑥ ⑧ ⑨

PK 2 6 6 P D B - P 10 - L

① ② ③ ④ ⑤ ⑥ ⑦ ⑧ ⑨ ⑩

①	Series Name	PK: PK Series
②	2: 2-Phase	
③	Motor Frame Size	6: 56.4 mm 9: 85 mm
④	Motor Case Length	
⑤	Number of Lead Wires or Motor Terminals	D, D1: 4 Leads, 4 Terminals E: 8 Terminals
⑥	Motor Shaft Type	A: Single Shaft
⑦	Motor Type	W: With Cable T: With Terminal Box

①	Series Name	PK: PK Series
②	2: 2-Phase	
③	Motor Frame Size	4: 42 mm 6: 56.4 mm 9: 85 mm
④	Motor Case Length	
⑤	Number of Lead Wires	D: 4
⑥	Winding Specifications	14: Rated Current 1.4 A/Phase 28: Rated Current 2.8 A/Phase
⑦	Motor Shaft Type	A: Single Shaft B: Double Shaft

①	Series Name	PK: PK Series
②	2: 2-Phase	
③	Motor Frame Size	4: 42 mm 5: 50 mm 6: 56.4 mm 9: 85 mm
④	Motor Case Length	
⑤	Motor Type	Blank: Standard Type (1.8°/Step) M: High-Resolution Type (0.9°/Step)
⑥	Reference Number	
⑦	Winding Specifications	
⑧	Motor Shaft Type	A: Single Shaft B: Double Shaft

①	Series Name	PK: PK Series
②	2: 2-Phase	
③	Motor Frame Size	4: 42 mm 6: 56.4 mm
④	Motor Case Length	
⑤	Motor Type	Blank: Standard Type (1.8°/step) M: High-Resolution Type (0.9°/step)
⑥	Reference Number	
⑦	Winding Specifications	
⑧	Motor Shaft Type	A: Single Shaft B: Double Shaft
⑨	Encoder Resolution	R21: 200 P/R R22: 400 P/R
⑩	Encoder Cable	L: Included (0.6 m)

①	Series	PK: PK Series
②	2: 2-Phase	
③	Motor Frame Size	2: 28 mm 4: 42 mm 6: 60 mm 9: 90 mm
④	Motor Case Length	
⑤	Motor Type	
⑥	Number of Lead Wires	1 or 2: 6 Leads D: 4 Leads E: 8 Leads
⑦	Shaft Type	A: Single Shaft B: Double Shaft
⑧	Gearhead Type	SG: SH Geared Type T: TH Geared Type PS: PS Geared Type P: PL Geared type
⑨	Gear Ratio	
⑩	Connection Cable	L: Included (0.6 m)

Introduction
AC Input Motor & Driver
0.36°/Geared AR
0.72°/Geared RK
0.36°/Geared AR
0.36°/0.72°/Geared CRK
DC Input Motor & Driver
1.8°/Geared RK
0.9°/1.8°/Geared CMK
0.72° PK
1.8°/Geared High-Torque PKD
Motor Only
0.9°/1.8°/Geared PK
Controllers SG8030JY
Accessories

28 mm

42 mm

50 mm

56.4 mm

60 mm

85 mm

90 mm

Product Line

● High-Resolution Type (4 lead wires)

Product Name (Single shaft)	Product Name (Double shaft)
PK243MD15A	PK243MD15B
PK244MD15A	PK244MD15B
PK245MD15A	PK245MD15B
PK264MD14A	PK264MD14B
PK264MD28A	PK264MD28B
PK264MD42A	PK264MD42B
PK266MD14A	PK266MD14B
PK266MD28A	PK266MD28B
PK266MD42A	PK266MD42B
PK268MD14A	PK268MD14B
PK268MD28A	PK268MD28B
PK268MD42A	PK268MD42B

● High-Resolution Type (6 lead wires)

Product Name (Single shaft)	Product Name (Double shaft)
PK243M-01A	PK243M-01B
PK243M-02A	PK243M-02B
PK243M-03A	PK243M-03B
PK244M-01A	PK244M-01B
PK244M-02A	PK244M-02B
PK244M-03A	PK244M-03B
PK245M-01A	PK245M-01B
PK245M-02A	PK245M-02B
PK245M-03A	PK245M-03B
PK264M-01A	PK264M-01B
PK264M-02A	PK264M-02B
PK264M-03A	PK264M-03B
PK264M-E2.0A	PK264M-E2.0B
PK266M-01A	PK266M-01B
PK266M-02A	PK266M-02B
PK266M-03A	PK266M-03B
PK266M-E2.0A	PK266M-E2.0B
PK268M-01A	PK268M-01B
PK268M-02A	PK268M-02B
PK268M-03A	PK268M-03B
PK268M-E2.0A	PK268M-E2.0B

● High-Resolution Type with Encoder (6 lead wires)

Product Name (Single shaft)
PK243M-01AR22-L
PK243M-02AR22-L
PK243M-03AR22-L
PK244M-01AR22-L
PK244M-02AR22-L
PK244M-03AR22-L
PK245M-01AR22-L
PK245M-02AR22-L
PK245M-03AR22-L
PK264M-01AR22-L
PK264M-02AR22-L
PK264M-03AR22-L
PK264MEAR22-L
PK266M-01AR22-L
PK266M-02AR22-L
PK266M-03AR22-L
PK266MEAR22-L
PK268M-01AR22-L
PK268M-02AR22-L
PK268M-03AR22-L
PK268MEAR22-L

● High-Torque, High-Efficiency Type (4 lead wires)

Product Name (Single shaft)	Product Name (Double shaft)
PKE243DA-L	PKE243DB-L
PKE244DA-L	PKE244DB-L
PKE245DA-L	PKE245DB-L

● High-Torque, High-Efficiency Type (6 lead wires)

Product Name (Single shaft)	Product Name (Double shaft)
PKE243A-L	PKE243B-L
PKE244A-L	PKE244B-L
PKE245A-L	PKE245B-L

● High-Torque Type (4 lead wires)

Product Name (Single shaft)	Product Name (Double shaft)
PK264JDA	PK264JDB
PK266JDA	PK266JDB
PK267JDA	PK267JDB
PK269JDA	PK269JDB

● High-Torque Type (6 lead wires)

Product Name (Single shaft)	Product Name (Double shaft)
PK264JA	PK264JB
PK266JA	PK266JB
PK267JA	PK267JB
PK269JA	PK269JB

● Standard Type (4 lead wires)

Product Name (Single shaft)	Product Name (Double shaft)
PK243DA	PK243DB
PK244DA	PK244DB
PK245DA	PK245DB
PK264D14A	PK264D14B
PK264D28A	PK264D28B
PK264DA	PK264DB
PK266D14A	PK266D14B
PK266D28A	PK266D28B
PK266DA	PK266DB
PK268D14A	PK268D14B
PK268D28A	PK268D28B
PK268DA	PK268DB
PK296DA	PK296DB
PK299DA	PK299DB
PK2913DA	PK2913DB

● Standard Type (6 lead wires)

Product Name (Single shaft)	Product Name (Double shaft)
PK243-01A	PK243-01B
PK243-02A	PK243-02B
PK243-03A	PK243-03B
PK244-01A	PK244-01B
PK244-02A	PK244-02B
PK244-03A	PK244-03B
PK244-04A	PK244-04B
PK245-01A	PK245-01B
PK245-02A	PK245-02B
PK245-03A	PK245-03B
PK256-02A	PK256-02B
PK258-02A	PK258-02B
PK264-01A	PK264-01B
PK264-02A	PK264-02B
PK264-03A	PK264-03B
PK264-E2.0A	PK264-E2.0B
PK266-01A	PK266-01B
PK266-02A	PK266-02B
PK266-03A	PK266-03B
PK266-E2.0A	PK266-E2.0B
PK268-01A	PK268-01B
PK268-02A	PK268-02B
PK268-03A	PK268-03B
PK268-E2.0A	PK268-E2.0B
PK296-E4.5A	PK296-E4.5B
PK299-E4.5A	PK299-E4.5B
PK2913-E4.0A	PK2913-E4.0B

● Standard Type with Encoder (6 lead wires)

Product Name (Single shaft)
PK243-01AR21-L
PK243-01AR22-L
PK243-02AR21-L
PK243-02AR22-L
PK243-03AR21-L
PK243-03AR22-L
PK244-01AR21-L
PK244-01AR22-L
PK244-02AR21-L
PK244-02AR22-L
PK244-03AR21-L
PK244-03AR22-L
PK245-01AR21-L
PK245-01AR22-L
PK245-02AR21-L
PK245-02AR22-L
PK245-03AR21-L
PK245-03AR22-L
PK264-01AR21-L
PK264-01AR22-L
PK264-02AR21-L
PK264-02AR22-L
PK264-03AR21-L
PK264-03AR22-L
PK264EAR21-L
PK264EAR22-L
PK266-01AR21-L
PK266-01AR22-L
PK266-02AR21-L
PK266-02AR22-L
PK266-03AR21-L
PK266-03AR22-L
PK266EAR21-L
PK266EAR22-L
PK268-01AR21-L
PK268-01AR22-L
PK268-02AR21-L
PK268-02AR22-L
PK268-03AR21-L
PK268-03AR22-L
PK268EAR21-L
PK268EAR22-L

● Standard Type with Cable

Product Name (Single shaft)
PK264DW
PK266DW
PK268DW
PK296DW
PK299DW
PK2913DW

● Standard Type with Terminal Box

Product Name (Single shaft)
PK264DAT
PK264D1T
PK266DAT
PK266D1T
PK268DAT
PK268D1T
PK296DT
PK296EAT
PK299DT
PK299EAT
PK2913DT
PK2913EAT

● SH Geared Type (6 lead wires)

Product Name (Single shaft)	Product Name (Double shaft)
PK243A1-SG3.6	PK243B1-SG3.6
PK243A1-SG7.2	PK243B1-SG7.2
PK243A1-SG9	PK243B1-SG9
PK243A1-SG10	PK243B1-SG10
PK243A1-SG18	PK243B1-SG18
PK243A1-SG36	PK243B1-SG36
PK243A1-SG50	PK243B1-SG50
PK243A1-SG100	PK243B1-SG100
PK264AE-SG3.6	PK264BE-SG3.6
PK264AE-SG7.2	PK264BE-SG7.2
PK264AE-SG9	PK264BE-SG9
PK264AE-SG10	PK264BE-SG10
PK264AE-SG18	PK264BE-SG18
PK264AE-SG36	PK264BE-SG36
PK264A2-SG3.6	PK264B2-SG3.6
PK264A2-SG7.2	PK264B2-SG7.2
PK264A2-SG9	PK264B2-SG9
PK264A2-SG10	PK264B2-SG10
PK264A2-SG18	PK264B2-SG18
PK264A2-SG36	PK264B2-SG36
PK264A2-SG50	PK264B2-SG50
PK264A2-SG100	PK264B2-SG100
PK296AE-SG3.6	PK296BE-SG3.6
PK296AE-SG7.2	PK296BE-SG7.2
PK296AE-SG9	PK296BE-SG9
PK296AE-SG10	PK296BE-SG10
PK296AE-SG18	PK296BE-SG18
PK296AE-SG36	PK296BE-SG36

● TH Geared Type (4 lead wires)

Product Name (Single shaft)	Product Name (Double shaft)
PK243DA-T3.6	PK243DB-T3.6
PK243DA-T7.2	PK243DB-T7.2
PK243DA-T10	PK243DB-T10
PK243DA-T20	PK243DB-T20
PK243DA-T30	PK243DB-T30
PK264DA-T3.6	PK264DB-T3.6
PK264DA-T7.2	PK264DB-T7.2
PK264DA-T10	PK264DB-T10
PK264DA-T20	PK264DB-T20
PK264DA-T30	PK264DB-T30

● TH Geared Type (6 lead wires)

Product Name (Single shaft)	Product Name (Double shaft)
PK243A1-T3.6	PK243B1-T3.6
PK243A1-T7.2	PK243B1-T7.2
PK243A1-T10	PK243B1-T10
PK243A1-T20	PK243B1-T20
PK243A1-T30	PK243B1-T30
PK264A2-T3.6	PK264B2-T3.6
PK264A2-T7.2	PK264B2-T7.2
PK264A2-T10	PK264B2-T10
PK264A2-T20	PK264B2-T20
PK264A2-T30	PK264B2-T30

● PS Geared Type (4 lead wires)

Product Name (Single shaft)	Product Name (Double shaft)
PK223PDA-PS5-L	PK223PDB-PS5-L
PK223PDA-PS10-L	PK223PDB-PS10-L

● PL Geared Type (4 lead wires)

Product Name (Single shaft)	Product Name (Double shaft)
PK244PDA-P5-L	PK244PDB-P5-L
PK244PDA-P10-L	PK244PDB-P10-L
PK244PDA-P36-L	PK244PDB-P36-L
PK266PDA-P5-L	PK266PDB-P5-L
PK266PDA-P10-L	PK266PDB-P10-L
PK266PDA-P36-L	PK266PDB-P36-L

The following items are included in each product.

Motor, Connection Cable*1,

Mounting Screws for Motor*2, Operating Manual

*1 Only products that have product names that end in 'L'

*2 SH geared type only



Step Angle 0.9° Frame Size 42 mm (4 lead wires)

High-Resolution Type

Specifications RoHS

Product Name	Connection Type	Maximum Holding Torque	Rotor Inertia	Rated Current	Voltage	Resistance per Phase	Inductance	Basic Step Angle	Wirings and Connections
Single Shaft Double Shaft		N·m	J: kg·m ²	A/Phase	VDC	Ω/Phase	mH/Phase		(See Page A-334)
PK243MD15A PK243MD15B	Bipolar	0.2	35×10 ⁻⁷	1.5	2.52	1.68	3	0.9°	①
PK244MD15A PK244MD15B		0.31	54×10 ⁻⁷		3.15	2.1	5.4		
PK245MD15A PK245MD15B		0.38	68×10 ⁻⁷		3.18	2.12	5.1		

Speed – Torque Characteristics

PK243MD15A/PK243MD15B

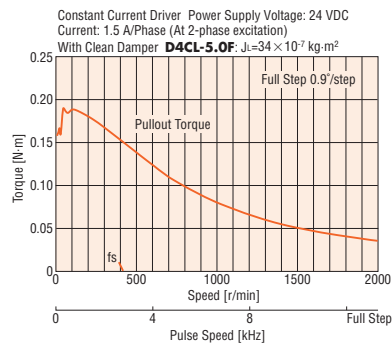

PK244MD15A/PK244MD15B

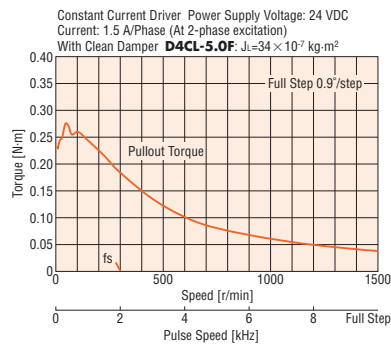

PK245MD15A/PK245MD15B

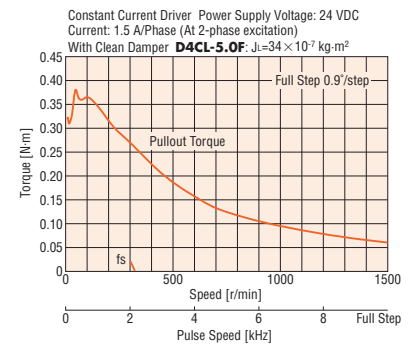

Note

● Depending on the driving conditions, a considerable amount of heat may be generated by the motor. Be sure to keep the motor case temperature at 100°C or less.

Dimensions (Unit = mm)

Product Name	L1	L2	Mass kg
PK243MD15A PK243MD15B	33	— 48	0.24
PK244MD15A PK244MD15B	39	— 54	0.3
PK245MD15A PK245MD15B	47	— 62	0.37

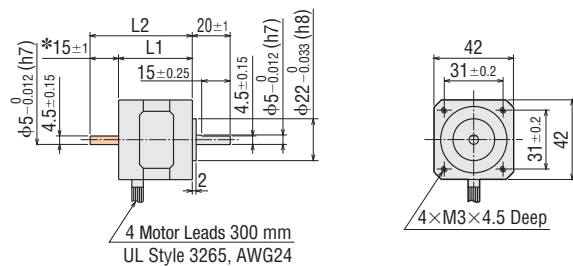

*The length of the shaft flat on the double shaft model is 15±0.25.

● These dimensions are for double shaft models.

For single shaft models, ignore the shaft in the shaded areas.

Step Angle 0.9° Frame Size 42 mm (6 lead wires)

High-Resolution Type

Specifications RoHS

Product Name	Connection Type	Maximum Holding Torque	Rotor Inertia	Rated Current	Voltage	Resistance per Phase	Inductance	Basic Step Angle	Wirings and Connections	Corresponding Motor/Driver Package	Package Product Speed-Torque Characteristics
Single Shaft Double Shaft		N·m	J: kg·m ²	A/Phase	VDC	Ω/Phase	mH/Phase		(See Page A-334)	Product Name	Page
PK243M-01A	Bipolar (Series)	0.2	35×10 ⁻⁷	0.67	5.6	8.4	15.2	0.9°	[3]	–	–
PK243M-01B	Unipolar	0.16		0.95	4	4.2	3.8		[2]	CMK243M□P	A-222
PK243M-02A	Bipolar (Series)	0.2		0.42	8.4	20	38.8		[3]	–	–
PK243M-02B	Unipolar	0.16		0.6	6	10	9.7		[2]	–	–
PK243M-03A	Bipolar (Series)	0.2		0.22	17	77	136		[3]	–	–
PK243M-03B	Unipolar	0.16		0.31	12	38.5	34		[2]	–	–
PK244M-01A	Bipolar (Series)	0.31	54×10 ⁻⁷	0.85	5.6	6.6	17.2		[3]	–	–
PK244M-01B	Unipolar	0.26		1.2	4	3.3	4.3		[2]	CMK244M□P	A-222
PK244M-02A	Bipolar (Series)	0.31		0.57	8.6	15	38.8		[3]	–	–
PK244M-02B	Unipolar	0.26		0.8	6	7.5	9.7		[2]	–	–
PK244M-03A	Bipolar (Series)	0.31		0.28	17	60	152		[3]	–	–
PK244M-03B	Unipolar	0.26		0.4	12	30	38		[2]	–	–
PK245M-01A	Bipolar (Series)	0.38	68×10 ⁻⁷	0.85	5.6	6.6	15.6		[3]	–	–
PK245M-01B	Unipolar	0.32		1.2	4	3.3	3.9		[2]	CMK245M□P	A-222
PK245M-02A	Bipolar (Series)	0.38		0.57	8.6	15	39.6		[3]	–	–
PK245M-02B	Unipolar	0.32		0.8	6	7.5	9.9		[2]	–	–
PK245M-03A	Bipolar (Series)	0.38		0.28	17	60	128		[3]	–	–
PK245M-03B	Unipolar	0.32		0.4	12	30	32		[2]	–	–

● **A** or **B** indicating motor shaft type is entered where the box □ is located within the product name.

● For the speed – torque characteristics of the motors in the table above, see the characteristics of the corresponding motor and driver package. If there is no corresponding package name, refer to the following characteristics.

Dimensions (Unit = mm)

Product Name	L1	L2	Mass kg
PK243M-0□A	33	–	0.24
PK243M-0□B		48	
PK244M-0□A	39	–	0.3
PK244M-0□B		54	
PK245M-0□A	47	–	0.37
PK245M-0□B		62	

● A number indicating the motor specification is entered where the box □ is located within the product name.

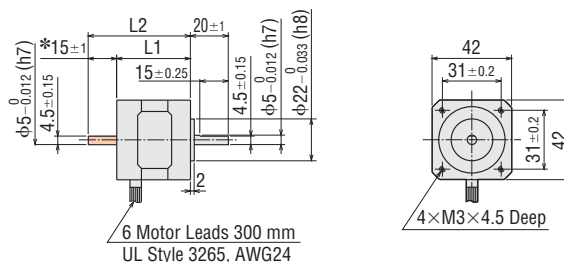

*The length of the shaft flat on the double shaft model is 15±0.25.

● These dimensions are for double shaft models.

For single shaft models, ignore the shaft in the shaded areas.

Step Angle 0.9° Frame Size 42 mm (6 lead wires)

High-Resolution Type with Encoder

Specifications RoHS

Product Name	Connection Type	Maximum Holding Torque	Rotor Inertia	Rated Current	Voltage	Resistance per Phase	Inductance	Basic Step Angle	Wirings and Connections
Single Shaft		N·m	J: kg·m ²	A/Phase	VDC	Ω/Phase	mH/Phase		(See Page A-334)
PK243M-01AR22-L	Bipolar (Series)	0.2	35×10 ⁻⁷	0.67	5.6	8.4	15.2	0.9°	[3]
	Unipolar	0.16		0.95	4	4.2	3.8		[2]
PK243M-02AR22-L	Bipolar (Series)	0.2		0.42	8.4	20	38.8		[3]
	Unipolar	0.16		0.6	6	10	9.7		[2]
PK243M-03AR22-L	Bipolar (Series)	0.2		0.22	17	77	136		[3]
	Unipolar	0.16		0.31	12	38.5	34		[2]
PK244M-01AR22-L	Bipolar (Series)	0.31	54×10 ⁻⁷	0.85	5.6	6.6	17.2		[3]
	Unipolar	0.26		1.2	4	3.3	4.3		[2]
PK244M-02AR22-L	Bipolar (Series)	0.31		0.57	8.6	15	38.8		[3]
	Unipolar	0.26		0.8	6	7.5	9.7		[2]
PK244M-03AR22-L	Bipolar (Series)	0.31		0.28	17	60	152		[3]
	Unipolar	0.26		0.4	12	30	38		[2]
PK245M-01AR22-L	Bipolar (Series)	0.38	68×10 ⁻⁷	0.85	5.6	6.6	15.6	[3]	
	Unipolar	0.32		1.2	4	3.3	3.9	[2]	
PK245M-02AR22-L	Bipolar (Series)	0.38		0.57	8.6	15	39.6	[3]	
	Unipolar	0.32		0.8	6	7.5	9.9	[2]	
PK245M-03AR22-L	Bipolar (Series)	0.38		0.28	17	60	128	[3]	
	Unipolar	0.32		0.4	12	30	32	[2]	

● "R22" in the product name indicate the encoder resolution.

R22: 400 pulses/revolution

● Encoder cable (0.6 m) is included.

Dimensions (Unit = mm)

Product Name	Motor Product Name	L1	L2	Mass kg
PK243M-0□AR22-L	PK243M-0□AR22	33	51.3	0.26
PK244M-0□AR22-L	PK244M-0□AR22	39	57.3	0.32
PK245M-0□AR22-L	PK245M-0□AR22	47	65.3	0.39

● A number indicating the motor specification is entered where the box □ is located within the product name.

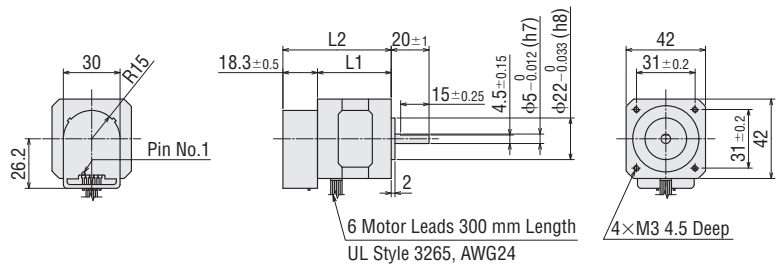

● Applicable Encoder Connector

Connector Product Name	Manufacturer
640442-5	Tyco Electronics Japan G. K.
HEDS-8903 (For 3-Channel: 5-lead wires)	Avago Technologies Limited
2695 Series (Housing)	Molex
2759 Series (Contact)	

● Included Encoder Cable

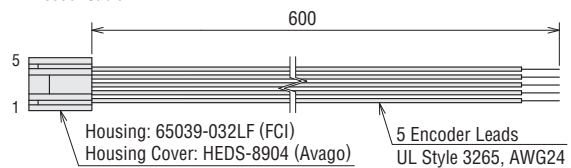

Encoder Specifications

→ Page A-336

Speed – Torque Characteristics

PK243M-01A/PK243M-01B PK243M-01AR22-L Bipolar (Series)

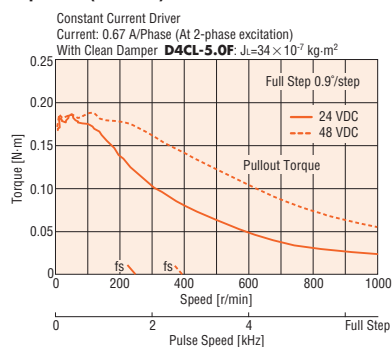

PK243M-02A/PK243M-02B PK243M-02AR22-L Bipolar (Series)

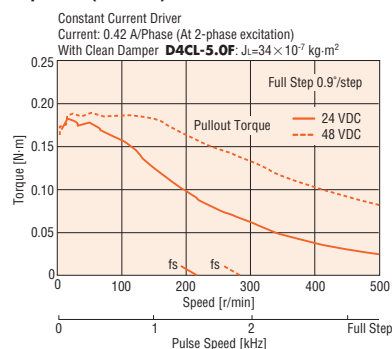

PK243M-02A/PK243M-02B PK243M-02AR22-L Unipolar

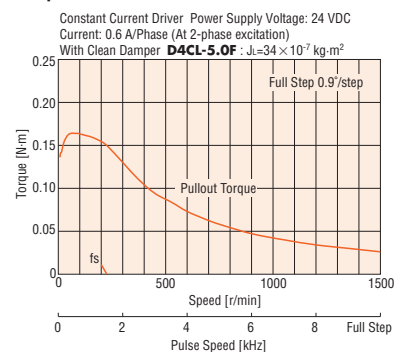

PK243M-03A/PK243M-03B PK243M-03AR22-L Bipolar (Series)

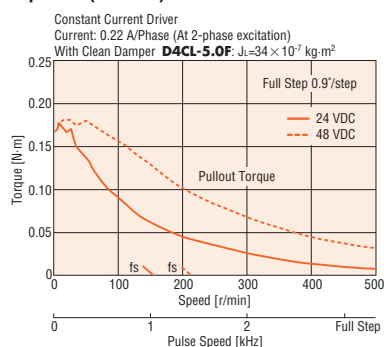

PK243M-03A/PK243M-03B PK243M-03AR22-L Unipolar

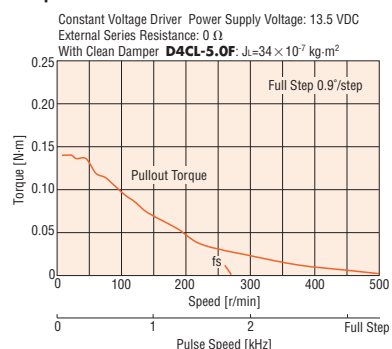

PK244M-01A/PK244M-01B PK244M-01AR22-L Bipolar (Series)

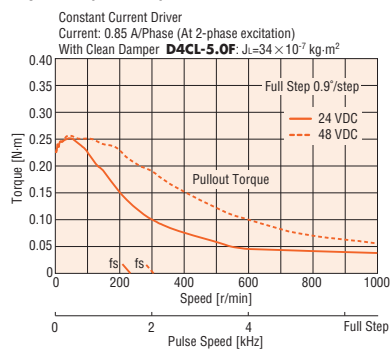

PK244M-02A/PK244M-02B PK244M-02AR22-L Bipolar (Series)

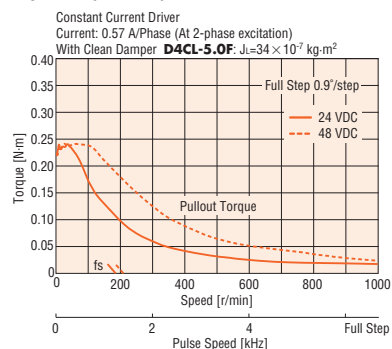

PK244M-02A/PK244M-02B PK244M-02AR22-L Unipolar

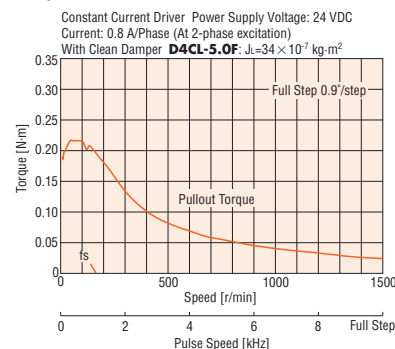

PK244M-03A/PK244M-03B PK244M-03AR22-L Unipolar

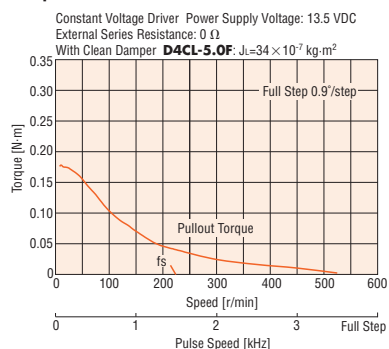

Note

● Depending on the driving conditions, a considerable amount of heat may be generated by the motor. Be sure to keep the motor case temperature at 100°C or less.

28 mm

42 mm

50 mm

56.4 mm

60 mm

85 mm

90 mm

Speed – Torque Characteristics

PK245M-01A/PK245M-01B PK245M-01AR22-L

Bipolar (Series)

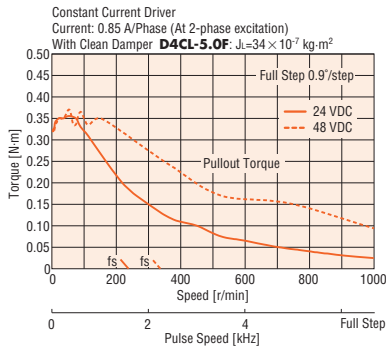

PK245M-02A/PK245M-02B PK245M-02AR22-L

Bipolar (Series)

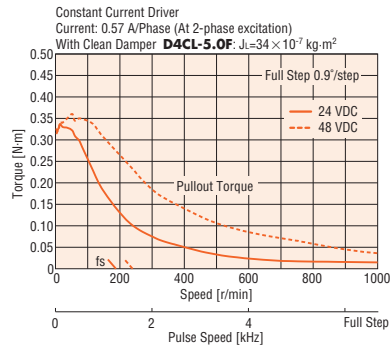

PK245M-02A/PK245M-02B PK245M-02AR22-L

Unipolar

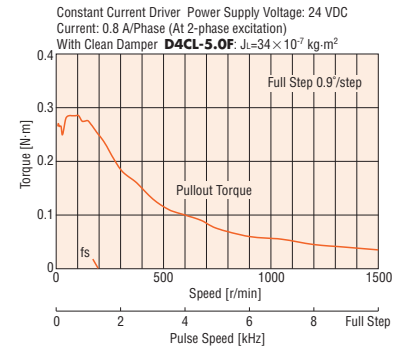

PK245M-03A/PK245M-03B PK245M-03AR22-L

Unipolar

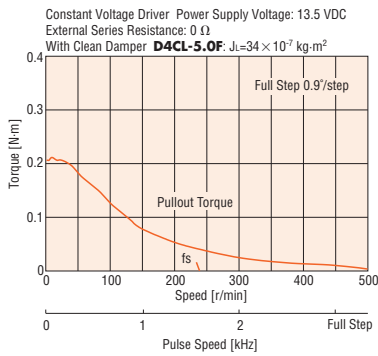

Note

● Depending on the driving conditions, a considerable amount of heat may be generated by the motor. Be sure to keep the motor case temperature at 100°C or less.

Step Angle 0.9° Frame Size 56.4 mm (4 lead wires)

High-Resolution Type

Specifications RoHS

Product Name Single Shaft Double Shaft	Connection Type	Maximum Holding Torque N·m	Rotor Inertia J: kg·m ²	Rated Current A/Phase	Voltage VDC	Resistance per Phase Ω/Phase	Inductance mH/Phase	Basic Step Angle	Wirings and Connections (See Page A-334)
PK264MD14A PK264MD14B	Bipolar	0.48	120×10 ⁻⁷	1.4	3.92	2.8	6.8	0.9°	[1]
PK264MD28A PK264MD28B				2.8	1.96	0.7	1.7		
PK264MD42A PK264MD42B				4.2	1.26	0.3	0.75		
PK266MD14A PK266MD14B		1.17	300×10 ⁻⁷	1.4	5.04	3.6	12.8		
PK266MD28A PK266MD28B				2.8	2.52	0.9	3.2		
PK266MD42A PK266MD42B				4.2	1.68	0.4	1.45		
PK268MD14A PK268MD14B		1.75	480×10 ⁻⁷	1.4	6.02	4.3	19.4		
PK268MD28A PK268MD28B				2.8	3.16	1.13	4.8		
PK268MD42A PK268MD42B				4.2	2.1	0.5	2.1		

Speed – Torque Characteristics

PK264MD14A/PK264MD14B

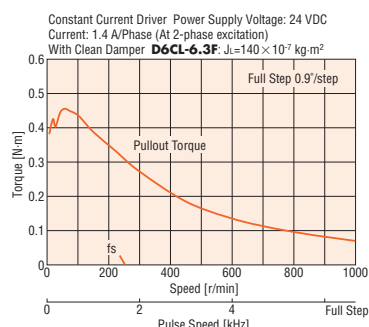

PK264MD28A/PK264MD28B

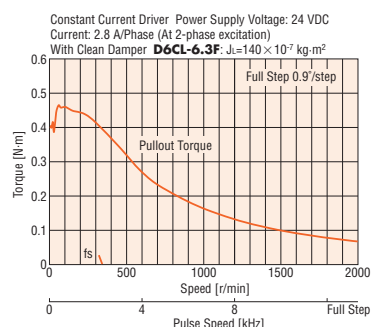

PK264MD42A/PK264MD42B

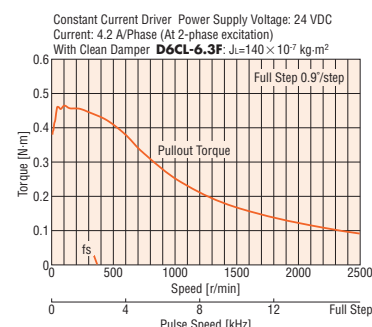

PK266MD14A/PK266MD14B

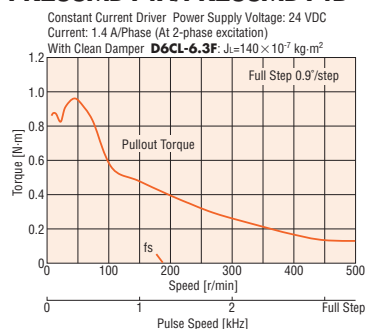

PK266MD28A/PK266MD28B

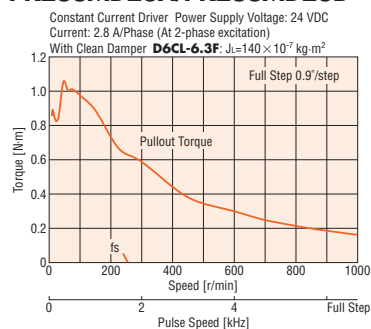

PK266MD42A/PK266MD42B

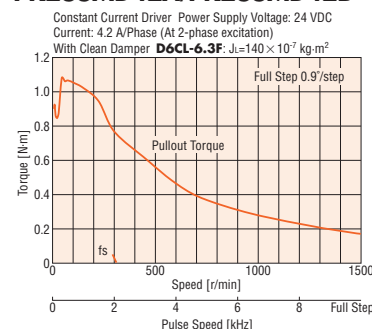

PK268MD14A/PK268MD14B

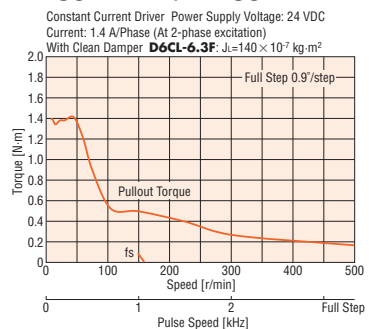

PK268MD28A/PK268MD28B

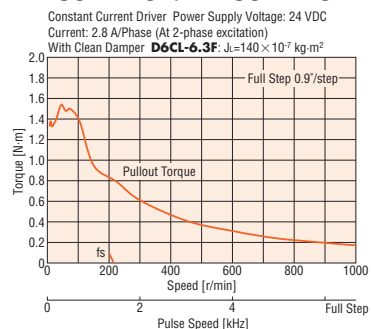

PK268MD42A/PK268MD42B

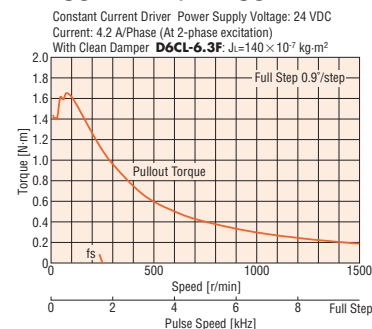

Note

● Depending on the driving conditions, a considerable amount of heat may be generated by the motor. Be sure to keep the motor case temperature at 100°C or less.

□28 mm

□42 mm

□50 mm

□56.4 mm

□60 mm

□85 mm

□90 mm

Dimensions (Unit = mm)

Product Name	L1	L2	Mass kg
PK264MD□A	39	-	0.45
PK264MD□B		55	
PK266MD□A	54	-	0.7
PK266MD□B		70	
PK268MD□A	76	-	1
PK268MD□B		92	

● A number indicating the motor specification is entered where the box □ is located within the product name.

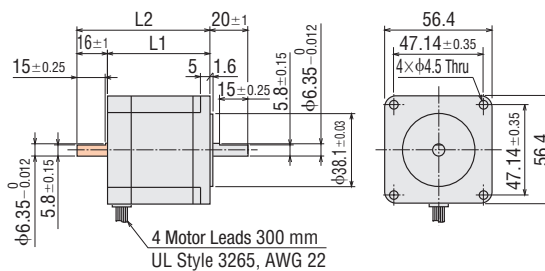

● These dimensions are for double shaft models.
For single shaft models, ignore the shaft in the shaded areas.

Step Angle 0.9° Frame Size 56.4 mm (6 or 8 lead wires)

High-Resolution Type

Specifications RoHS

Product Name Single Shaft Double Shaft	Connection Type	Maximum Holding Torque N-m	Rotor Inertia J: kg-m ²	Rated Current A/Phase	Voltage VDC	Resistance per Phase Ω/Phase	Inductance mH/Phase	Basic Step Angle	Wirings and Connections (See Page A-334)	Corresponding Motor/Driver Package	Package Product Speed-Torque Characteristics
										Product Name	Page
PK264M-01A	Bipolar (Series)	0.48	120×10 ⁻⁷	0.71	8.1	11.4	26	0.9°	[3]	-	-
PK264M-01B	Unipolar	0.39		1	5.7	5.7	6.5		[2]	-	-
PK264M-02A	Bipolar (Series)	0.48		1.4	3.9	2.8	6.8		[3]	-	-
PK264M-02B	Unipolar	0.39		2	2.8	1.4	1.7		[2]	CMK264M□P	A-222
PK264M-03A	Bipolar (Series)	0.48		2.1	2.6	1.26	3		[3]	-	-
PK264M-03B	Unipolar	0.39		3	1.9	0.63	0.75		[2]	-	-
PK264M-E2.0A	Bipolar (Parallel)	0.48		2.8	1.96	0.7	1.7		[6]	-	-
PK264M-E2.0B	Bipolar (Series)	0.48		1.4	3.9	2.8	6.8		[5]	-	-
	Unipolar	0.39		2	2.8	1.4	1.7		[4]	-	-
PK266M-01A	Bipolar (Series)	1.17		300×10 ⁻⁷	0.71	11	14.8		50.8	0.9°	[3]
PK266M-01B	Unipolar	0.9	1		7.4	7.4	12.7	[2]	-		-
PK266M-02A	Bipolar (Series)	1.17	1.4		5	3.6	12.8	[3]	-		-
PK266M-02B	Unipolar	0.9	2		3.6	1.8	3.2	[2]	CMK266M□P		A-222
PK266M-03A	Bipolar (Series)	1.17	2.1		3.2	1.5	5.8	[3]	-		-
PK266M-03B	Unipolar	0.9	3		2.3	0.75	1.45	[2]	-		-
PK266M-E2.0A	Bipolar (Parallel)	1.17	2.8		2.52	0.9	3.2	[6]	-		-
PK266M-E2.0B	Bipolar (Series)	1.17	1.4		5	3.6	12.8	[5]	-		-
	Unipolar	0.9	2		3.6	1.8	3.2	[4]	-		-
PK268M-01A	Bipolar (Series)	1.75	480×10 ⁻⁷		0.71	12	17.2	77.6	0.9°		[3]
PK268M-01B	Unipolar	1.35		1	8.6	8.6	19.4	[2]		-	-
PK268M-02A	Bipolar (Series)	1.75		1.4	6.3	4.5	19.2	[3]		-	-
PK268M-02B	Unipolar	1.35		2	4.5	2.25	4.8	[2]		CMK268M□P	A-222
PK268M-03A	Bipolar (Series)	1.75		2.1	4.2	2	8.4	[3]		-	-
PK268M-03B	Unipolar	1.35		3	3	1	2.1	[2]		-	-
PK268M-E2.0A	Bipolar (Parallel)	1.75		2.8	3.16	1.13	4.8	[6]		-	-
PK268M-E2.0B	Bipolar (Series)	1.75		1.4	6.3	4.5	19.2	[5]		-	-
	Unipolar	1.35		2	4.5	2.25	4.8	[4]		-	-

● **A** or **B** indicating motor shaft type is entered where the box □ is located within the product name.

● For the speed – torque characteristics of the motors in the table above, see the characteristics of the corresponding motor and driver package. If there is no corresponding package name, refer to the following characteristics.

Dimensions (Unit = mm)

Product Name	L1	L2	Mass kg
PK264M-0□A PK264M-E2.0A	39	-	0.45
PK264M-0□B PK264M-E2.0B		55	
PK266M-0□A PK266M-E2.0A	54	-	0.7
PK266M-0□B PK266M-E2.0B		70	
PK268M-0□A PK268M-E2.0A	76	-	1.0
PK268M-0□B PK268M-E2.0B		92	

● A number indicating the motor specification is entered where the box □ is located within the product name.

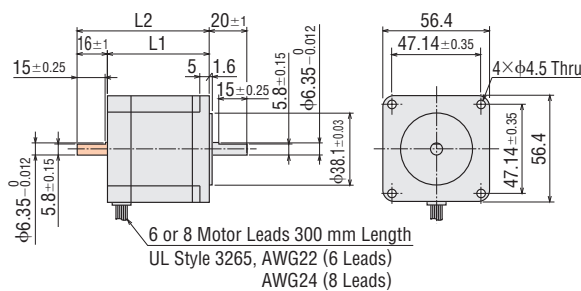

● These dimensions are for double shaft models.

For single shaft models, ignore the shaft in the shaded areas.

Step Angle 0.9° Frame Size 56.4 mm (6 or 8 lead wires)

High-Resolution Type with Encoder

Specifications (RoHS)

Product Name	Connection Type	Maximum Holding Torque	Rotor Inertia	Rated Current	Voltage	Resistance per Phase	Inductance	Basic Step Angle	Wirings and Connections		
Single Shaft		N·m	J: kg·m ²	A/Phase	VDC	Ω/Phase	mH/Phase		(See Page A-334)		
PK264M-01AR22-L	Bipolar (Series)	0.48	120×10 ⁻⁷	0.71	8.1	11.4	26	0.9°	③		
	Unipolar	0.39		1	5.7	5.7	6.5		②		
PK264M-02AR22-L	Bipolar (Series)	0.48		1.4	3.9	2.8	6.8		③		
	Unipolar	0.39		2	2.8	1.4	1.7		②		
PK264M-03AR22-L	Bipolar (Series)	0.48		2.1	2.6	1.26	3		③		
	Unipolar	0.39		3	1.9	0.63	0.75		②		
PK264MEAR22-L	Bipolar (Parallel)	0.48		2.8	1.96	0.7	1.7		⑥		
	Bipolar (Series)	0.48		1.4	3.9	2.8	6.8		⑤		
	Unipolar	0.39		2	2.8	1.4	1.7		④		
PK266M-01AR22-L	Bipolar (Series)	1.17		300×10 ⁻⁷	0.71	11	14.8		50.8	0.9°	③
	Unipolar	0.9			1	7.4	7.4		12.7		②
PK266M-02AR22-L	Bipolar (Series)	1.17			1.4	5	3.6		12.8		③
	Unipolar	0.9	2		3.6	1.8	3.2	②			
PK266M-03AR22-L	Bipolar (Series)	1.17	2.1		3.2	1.5	5.8	③			
	Unipolar	0.9	3		2.3	0.75	1.45	②			
PK266MEAR22-L	Bipolar (Parallel)	1.17	2.8		2.52	0.9	3.2	⑥			
	Bipolar (Series)	1.17	1.4		5	3.6	12.8	⑤			
	Unipolar	0.9	2		3.6	1.8	3.2	④			
PK268M-01AR22-L	Bipolar (Series)	1.75	480×10 ⁻⁷		0.71	12	17.2	77.6	0.9°		③
	Unipolar	1.35			1	8.6	8.6	19.4			②
PK268M-02AR22-L	Bipolar (Series)	1.75			1.4	6.3	4.5	19.2			③
	Unipolar	1.35		2	4.5	2.25	4.8	②			
PK268M-03AR22-L	Bipolar (Series)	1.75		2.1	4.2	2	8.4	③			
	Unipolar	1.35		3	3	1	2.1	②			
PK268MEAR22-L	Bipolar (Parallel)	1.75		2.8	3.16	1.13	4.8	⑥			
	Bipolar (Series)	1.75		1.4	6.3	4.5	19.2	⑤			
	Unipolar	1.35		2	4.5	2.25	4.8	④			

● "R22" in the product name indicates the encoder resolution.

R22: 400 pulses/revolution

● Encoder cable (0.6 m) is included.

Dimensions (Unit = mm)

Product Name	Motor Product Name	L1	L2	Mass kg
PK264M-0□AR22-L	PK264M-0□AR22	39	57.3	0.47
PK264MEAR22-L	PK264MEAR22			
PK266M-0□AR22-L	PK266M-0□AR22	54	72.3	0.72
PK266MEAR22-L	PK266MEAR22			
PK268M-0□AR22-L	PK268M-0□AR22	76	94.3	1.02
PK268MEAR22-L	PK268MEAR22			

● A number indicating the motor specification is entered where the box □ is located within the product name.

● Applicable Encoder Connector

Connector Product Name	Manufacturer
640442-5	Tyco Electronics Japan G. K.
HEDS-8903 (For 3-Channel: 5-lead wires)	Avago Technologies Limited
2695 Series (Housing)	Molex
2759 Series (Contact)	

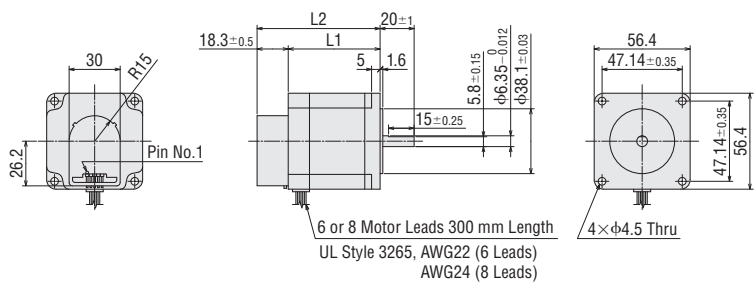

● Included

Encoder Cable

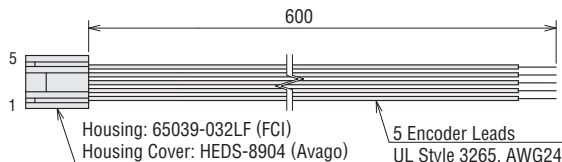

Encoder Specifications

→ Page A-336

Speed – Torque Characteristics

PK264M-01A/PK264M-01B PK264M-01AR22-L

Bipolar (Series)

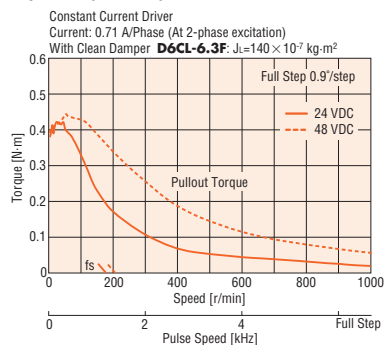

PK264M-03A/PK264M-03B PK264M-03AR22-L

Bipolar (Series)

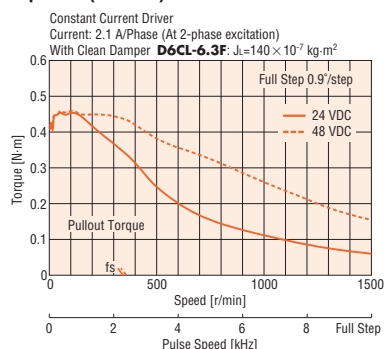

PK266M-01A/PK266M-01B PK266M-01AR22-L

Bipolar (Series)

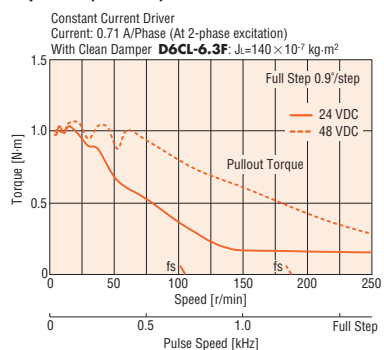

PK266M-03A/PK266M-03B PK266M-03AR22-L

Bipolar (Series)

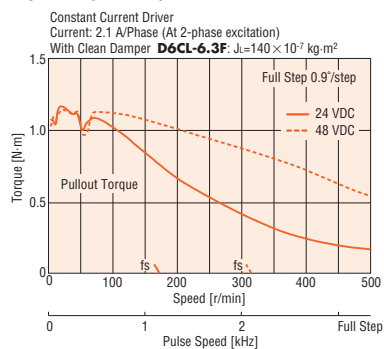

PK264M-01A/PK264M-01B PK264M-01AR22-L

Unipolar

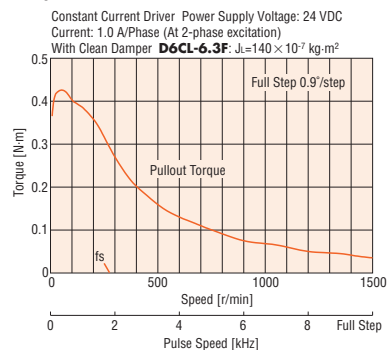

PK264M-03A/PK264M-03B PK264M-03AR22-L

Unipolar

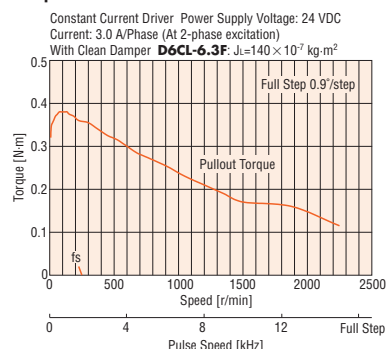

PK266M-01A/PK266M-01B PK266M-01AR22-L

Unipolar

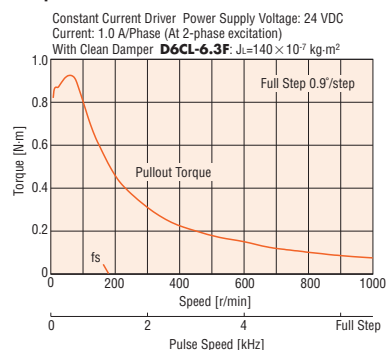

PK266M-03A/PK266M-03B PK266M-03AR22-L

Unipolar

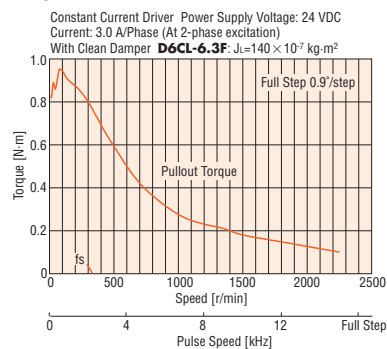

PK264M-02A/PK264M-02B PK264M-02AR22-L

Bipolar (Series)

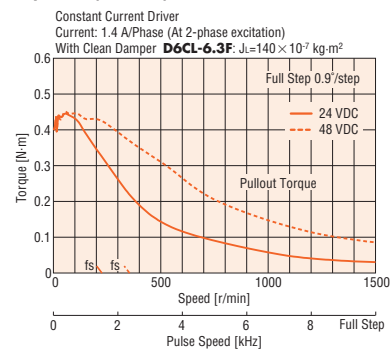

PK264M-E2.0A/PK264M-E2.0B PK264MEAR22-L

Bipolar (Parallel)

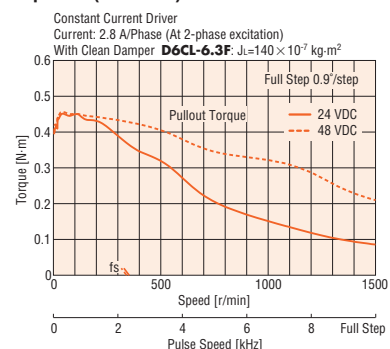

PK266M-02A/PK266M-02B PK266M-02AR22-L

Bipolar (Series)

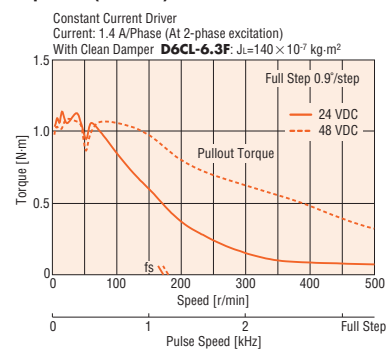

PK266M-E2.0A/PK266M-E2.0B PK266MEAR22-L

Bipolar (Parallel)

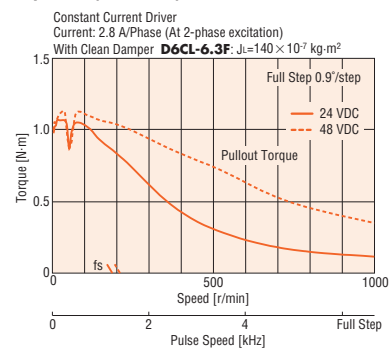

Note

● Depending on the driving conditions, a considerable amount of heat may be generated by the motor. Be sure to keep the motor case temperature at 100°C or less.

28 mm

42 mm

50 mm

56.4 mm

60 mm

85 mm

90 mm

Speed – Torque Characteristics

PK268M-01A/PK268M-01B PK268M-01AR22-L

Bipolar (Series)

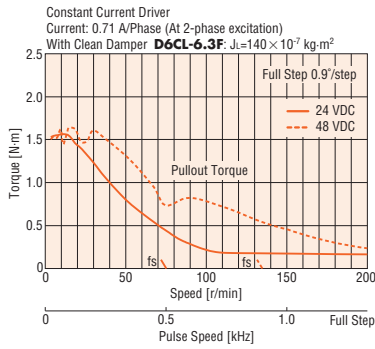

PK268M-01A/PK268M-01B PK268M-01AR22-L

Unipolar

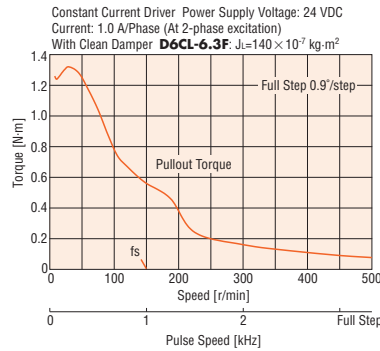

PK268M-02A/PK268M-02B PK268M-02AR22-L

Bipolar (Series)

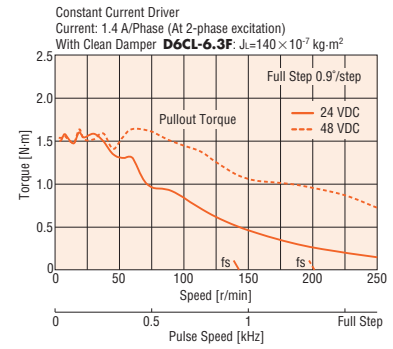

PK268M-03A/PK268M-03B PK268M-03AR22-L

Bipolar (Series)

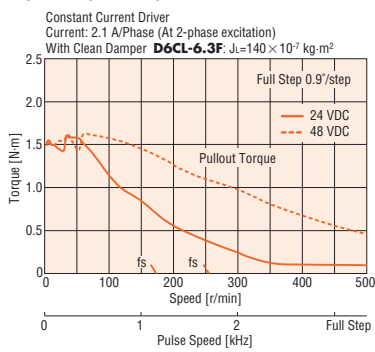

PK268M-03A/PK268M-03B PK268M-03AR22-L

Unipolar

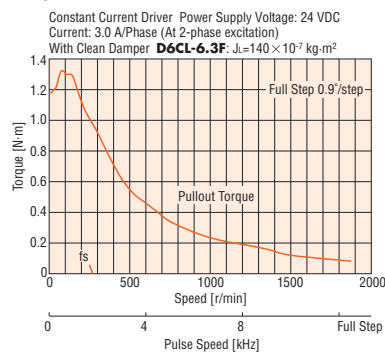

PK268M-E2.0A/PK268M-E2.0B PK268MEAR22-L

Bipolar (Parallel)

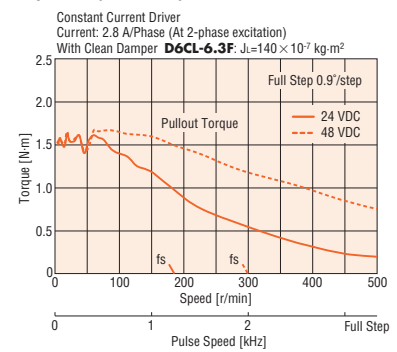

Note

● Depending on the driving conditions, a considerable amount of heat may be generated by the motor. Be sure to keep the motor case temperature at 100°C or less.

Step Angle 1.8° Frame Size 42 mm (4 lead wires)

High-Torque, High-Efficiency Type

Specifications (RoHS)

Product Name	Connection Type	Maximum Holding Torque	Rotor Inertia	Rated Current	Voltage	Resistance per Phase	Inductance	Basic Step Angle	Wirings and Connections
Single Shaft Double Shaft		N·m	J: kg·m ²	A/Phase	VDC	Ω/Phase	mH/Phase		(See Page A-334)
PKE243DA-L PKE243DB-L	Bipolar	0.3	36×10 ⁻⁷	1.5	1.93	1.29	3.7	1.8°	[1]
PKE244DA-L PKE244DB-L		0.48	57×10 ⁻⁷		3.9	2.6	6.25		
PKE245DA-L PKE245DB-L		0.55	83×10 ⁻⁷		2.9	1.94	7		

● Connection cable (0.6 m) is included.

Speed – Torque Characteristics

PKE243DA-L/PKE243DB-L

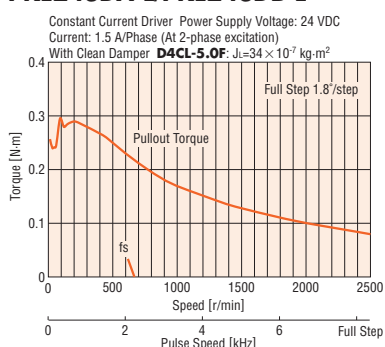

PKE244DA-L/PKE244DB-L

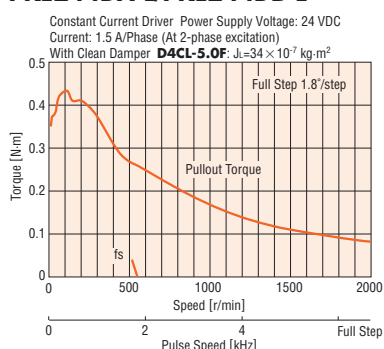

PKE245DA-L/PKE245DB-L

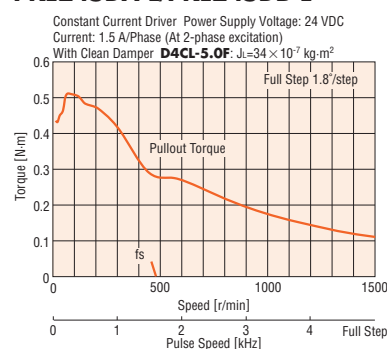

Note

● Depending on the driving conditions, a considerable amount of heat may be generated by the motor. Be sure to keep the motor case temperature at 100°C or less.

Dimensions (Unit = mm)

Product Name	Motor Product Name	L1	L2	Mass kg
PKE243DA-L	PKE243DA	33	—	0.25
PKE243DB-L	PKE243DB		48	
PKE244DA-L	PKE244DA	39	—	0.3
PKE244DB-L	PKE244DB		54	
PKE245DA-L	PKE245DA	47	—	0.39
PKE245DB-L	PKE245DB		62	

● Applicable Connector

Connector Housing: 51103-0600 (Molex)

Contact: 50351-8100 (Molex)

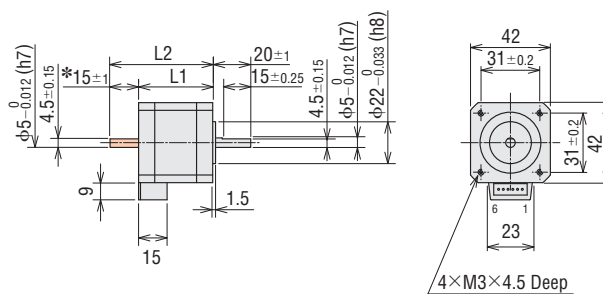

*The length of the shaft flat on the double shaft model is 15±0.25.

● These dimensions are for double shaft models.

For single shaft models, ignore the shaft in shaded areas.

● Included

Connection Cable

Product Name: **LC2B06B**

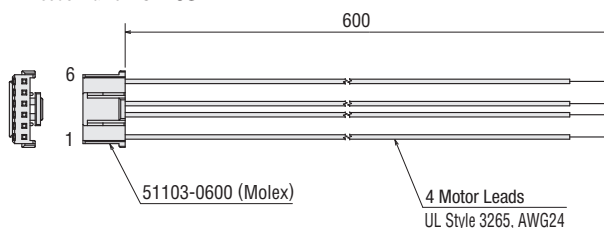

Accessories (Sold separately)

Connection cable and motor connector set are available as accessories.

● Connection cable → Page A-358

● Motor connector set → Page A-358

Step Angle 1.8° Frame Size 42 mm (6 lead wires)

High-Torque, High-Efficiency Type

Specifications RoHS

Product Name	Connection Type	Maximum Holding Torque	Rotor Inertia	Rated Current	Voltage	Resistance per Phase	Inductance	Basic Step Angle	Wiring and Connections
Single Shaft									
Double Shaft		N·m	J: kg·m ²	A/Phase	VDC	Ω/Phase	mH/Phase		(See Page A-334)
PKE243A-L PKE243B-L	Bipolar (Series)	0.3	36×10 ⁻⁷	0.67	4.42	6.6	18.8	1.8°	[3]
	Unipolar	0.24		0.95	3.14	3.3	4.7		[2]
PKE244A-L PKE244B-L	Bipolar (Series)	0.48	57×10 ⁻⁷	0.85	6.8	8	19.4		[3]
	Unipolar	0.39		1.2	4.8	4	4.85		[2]
PKE245A-L PKE245B-L	Bipolar (Series)	0.55	83×10 ⁻⁷	0.85	4.59	5.4	19.2		[3]
	Unipolar	0.44		1.2	3.24	2.7	4.8		[2]

● Connection cable (0.6 m) is included.

Speed – Torque Characteristics

PKE243A-L/PKE243B-L

Bipolar (Series)

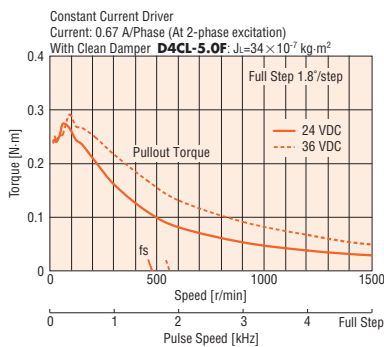

PKE243A-L/PKE243B-L

Unipolar

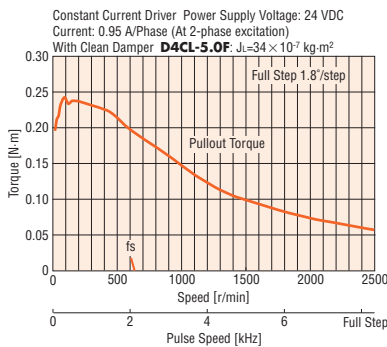

PKE244A-L/PKE244B-L

Bipolar (Series)

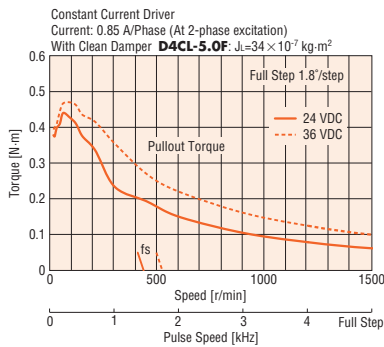

PKE244A-L/PKE244B-L

Unipolar

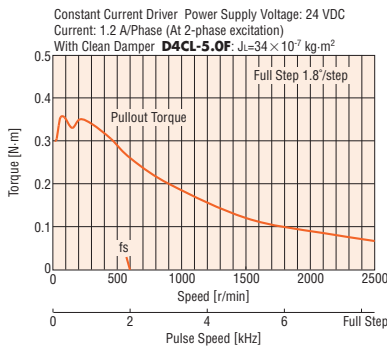

PKE245A-L/PKE245B-L

Bipolar (Series)

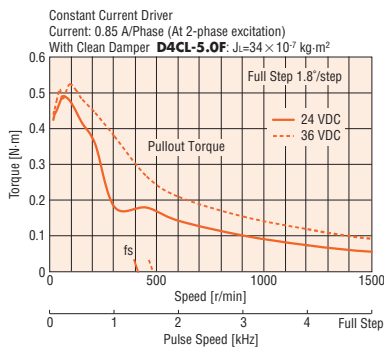

PKE245A-L/PKE245B-L

Unipolar

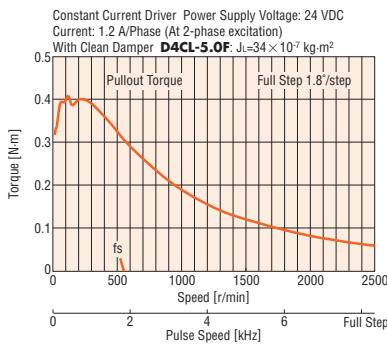

Note

● Depending on the driving conditions, a considerable amount of heat may be generated by the motor. Be sure to keep the motor case temperature at 100°C or less.

Dimensions (Unit = mm)

Product Name	Motor Product Name	L1	L2	Mass kg
PKE243A-L	PKE243A	33	-	0.25
PKE243B-L	PKE243B		48	
PKE244A-L	PKE244A	39	-	0.3
PKE244B-L	PKE244B		54	
PKE245A-L	PKE245A	47	-	0.39
PKE245B-L	PKE245B		62	

● Applicable Connector

Connector Housing: 51103-0600 (Molex)
Contact: 50351-8100 (Molex)

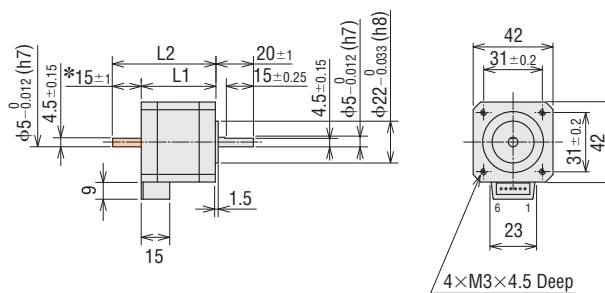

*The length of the shaft flat on the double shaft model is 15 ± 0.25 .

● These dimensions are for double shaft models.

For single shaft models, ignore the shaft in shaded areas.

● Included

Connection Cable
Product Name: **LC2U06B**

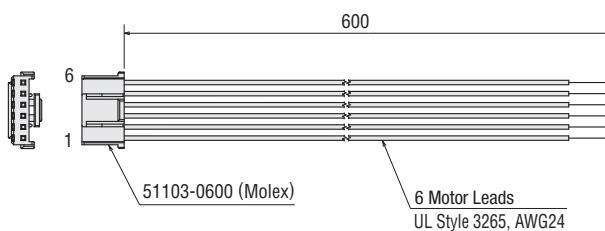

Accessories (Sold separately)

Connection cable and motor connector set are available as accessories.

● Connection cable → Page A-358

● Motor connector set → Page A-358

Introduction
0.36°/Geared AC Input Motor & Driver AR
0.72°/Geared RK
0.36°/Geared AR
0.36°/0.72°/ Geared DC Input Motor & Driver CRK
1.8°/Geared RRK
0.9°/1.8°/Geared CMK
0.72° PK
1.8°/Geared High-Torque Motor Only PKP
0.9°/1.8°/Geared PK
Controllers SG80301Y
Accessories

Step Angle 1.8° Frame Size 60 mm (4 lead wires)

High-Torque Type

Specifications (RoHS)

Product Name	Connection Type	Maximum Holding Torque	Rotor Inertia	Rated Current	Voltage	Resistance per Phase	Inductance	Basic Step Angle	Wirings and Connections
Single Shaft Double Shaft		N·m	J: kg·m ²	A/Phase	VDC	Ω/Phase	mH/Phase		(See Page A-334)
PK264JDA PK264JDB	Bipolar	1.06	280×10 ⁻⁷	2.8	2.1	0.73	1.8	1.8°	①
PK266JDA PK266JDB		1.75	450×10 ⁻⁷		2.8	1	3.05		
PK267JDA PK267JDB		2.2	570×10 ⁻⁷		3.4	1.2	3.54		
PK269JDA PK269JDB		3.1	900×10 ⁻⁷		4.2	1.49	5.7		

Speed – Torque Characteristics

PK264JDA/PK264JDB

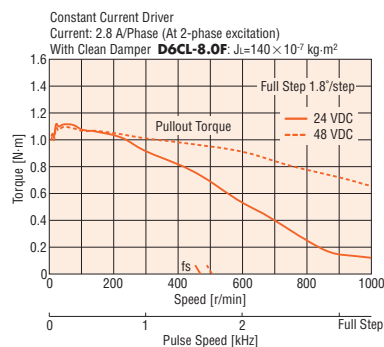

PK266JDA/PK266JDB

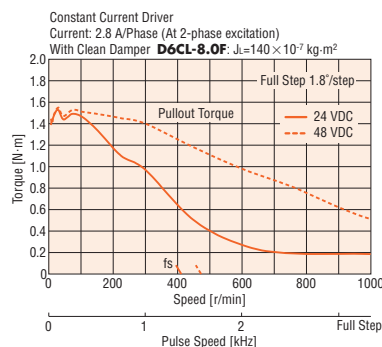

PK267JDA/PK267JDB

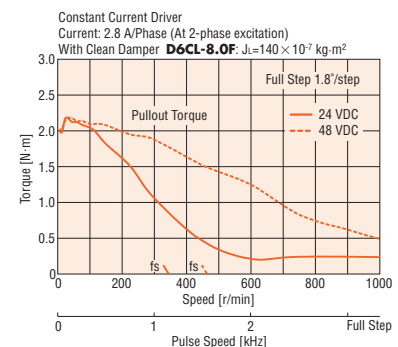

PK269JDA/PK269JDB

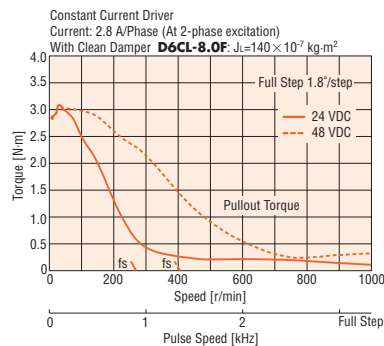

Note

● Depending on the driving conditions, a considerable amount of heat may be generated by the motor. Be sure to keep the motor case temperature at 100°C or less.

Dimensions (Unit = mm)

Product Name	L1	L2	Mass kg
PK264JDA PK264JDB	43.5	— 66.5	0.6
PK266JDA PK266JDB	54	— 77	0.83
PK267JDA PK267JDB	65	— 88	1.02
PK269JDA PK269JDB	85	— 108	1.43

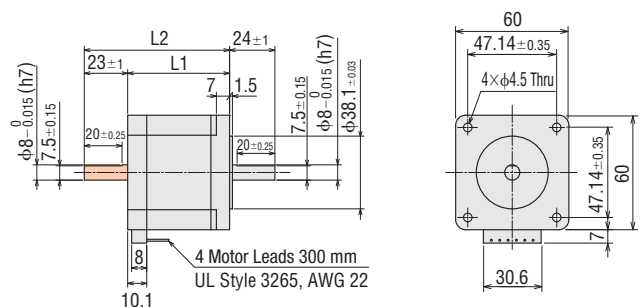

● These dimensions are for double shaft models.
For single shaft models, ignore the shaft in the shaded areas.

Step Angle 1.8° Frame Size 60 mm (6 lead wires)

High-Torque Type

Specifications RoHS

Product Name	Connection Type	Maximum Holding Torque	Rotor Inertia	Rated Current	Voltage	Resistance per Phase	Inductance	Basic Step Angle	Wiring and Connections
Single Shaft		N·m	J: kg·m ²	A/Phase	VDC	Ω/Phase	mH/Phase		(See Page A-334)
PK264JA PK264JB	Bipolar (Series)	1.06	280 × 10 ⁻⁷	1.4	4.1	2.92	7.2	1.8°	③
	Unipolar	0.75		2	2.9	1.46	1.8		②
PK266JA PK266JB	Bipolar (Series)	1.75	450 × 10 ⁻⁷	1.4	5.6	4	12.2		③
	Unipolar	1.35		2	4	2	3.05		②
PK267JA PK267JB	Bipolar (Series)	2.2	570 × 10 ⁻⁷	1.4	6.7	4.8	14.2		③
	Unipolar	1.7		2	4.8	2.4	3.54		②
PK269JA PK269JB	Bipolar (Series)	3.1	900 × 10 ⁻⁷	1.4	8.3	5.96	22.8		③
	Unipolar	2.2		2	6	2.98	5.7		②

Speed – Torque Characteristics

PK264JA/PK264JB

Bipolar (Series)

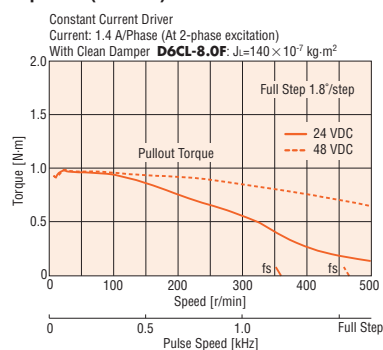

PK264JA/PK264JB

Unipolar

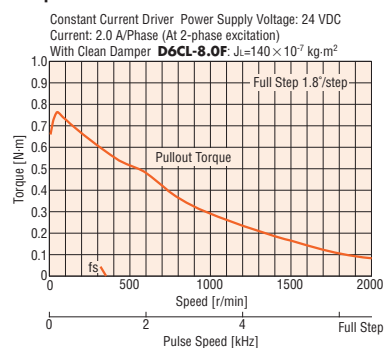

PK266JA/PK266JB

Bipolar (Series)

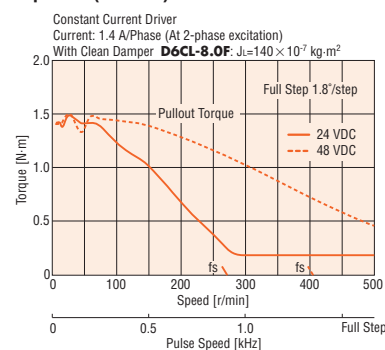

PK266JA/PK266JB

Unipolar

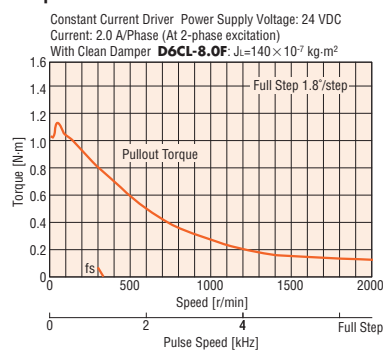

PK267JA/PK267JB

Bipolar (Series)

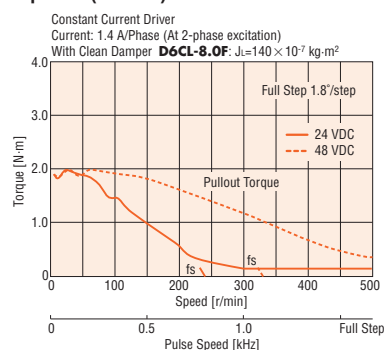

PK267JA/PK267JB

Unipolar

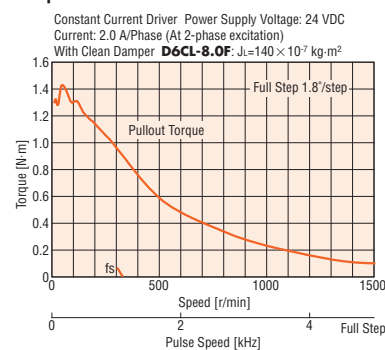

PK269JA/PK269JB

Bipolar (Series)

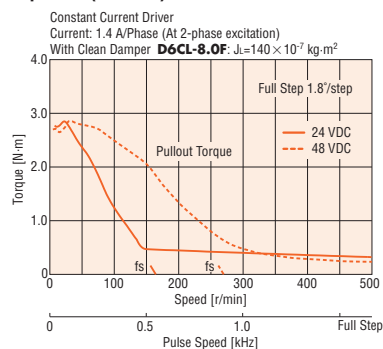

PK269JA/PK269JB

Unipolar

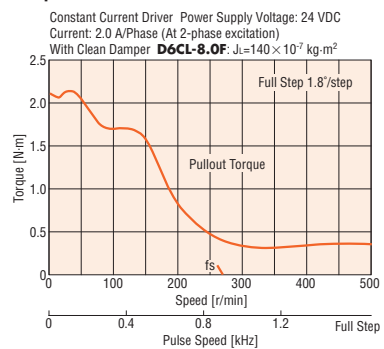

Note

● Depending on the driving conditions, a considerable amount of heat may be generated by the motor. Be sure to keep the motor case temperature at 100°C or less.

□ 28 mm

□ 42 mm

□ 50 mm

□ 56.4 mm

□ 60 mm

□ 85 mm

□ 90 mm

Dimensions (Unit = mm)

Product Name	L1	L2	Mass kg
PK264JDA	43.5	-	0.6
PK264JDB		66.5	
PK266JDA	54	-	0.83
PK266JDB		77	
PK267JDA	65	-	1.02
PK267JDB		88	
PK269JDA	85	-	1.43
PK269JDB		108	

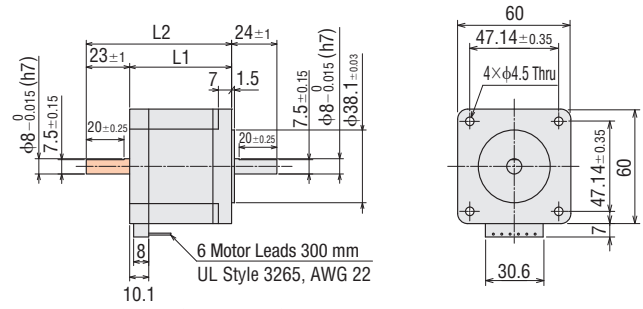

● These dimensions are for double shaft models.
For single shaft models, ignore the shaft in the shaded areas.

Step Angle 1.8° Frame Size 42 mm (4 lead wires)

Standard Type

Specifications RoHS

Product Name Single Shaft Double Shaft	Connection Type	Maximum Holding Torque N·m	Rotor Inertia J: kg·m ²	Rated Current A/Phase	Voltage VDC	Resistance per Phase Ω/Phase	Inductance mH/Phase	Basic Step Angle	Wirings and Connections (See Page A-334)
PK243DA PK243DB	Bipolar	0.2	35×10^{-7}	1.5	2.4	1.6	1.75	1.8°	①
PK244DA PK244DB		0.33	54×10^{-7}		3.45	2.3	3.9		
PK245DA PK245DB		0.43	68×10^{-7}		3.15	2.1	3.1		

Speed – Torque Characteristics

PK243DA/PK243DB

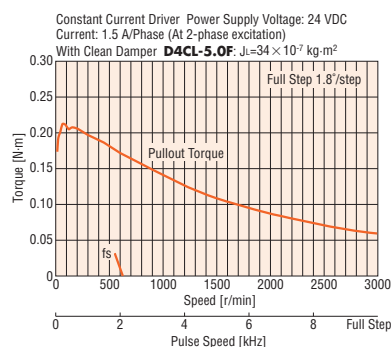

PK244DA/PK244DB

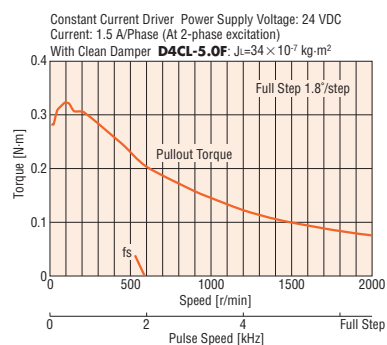

PK245DA/PK245DB

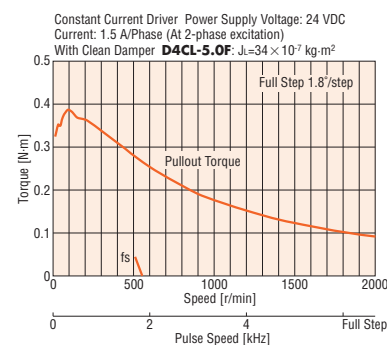

Note

● Depending on the driving conditions, a considerable amount of heat may be generated by the motor. Be sure to keep the motor case temperature at 100°C or less.

Dimensions (Unit = mm)

Product Name	L1	L2	Mass kg
PK243DA	33	—	0.21
PK243DB		48	
PK244DA	39	—	0.27
PK244DB		54	
PK245DA	47	—	0.35
PK245DB		62	

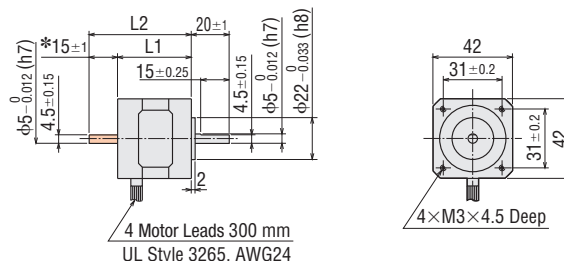

*The length of the shaft flat on the double shaft model is 15 ± 0.25 .

● These dimensions are for double shaft models.

For single shaft models, ignore the shaft in the shaded areas.

Step Angle 1.8° Frame Size 42 mm (6 lead wires)

Standard Type

Specifications RoHS

Product Name	Connection Type	Maximum Holding Torque	Rotor Inertia	Rated Current	Voltage	Resistance per Phase	Inductance	Basic Step Angle	Wirings and Connections (See Page A-334)	Corresponding Motor/Driver Package	Package Product Speed-Torque Characteristics
										Product Name	Page
Single Shaft Double Shaft		N·m	J: kg·m ²	A/Phase	VDC	Ω/Phase	mH/Phase				
PK243-01A	Bipolar (Series)	0.2	35×10 ⁻⁷	0.67	5.6	8.4	10	1.8°	[3]	–	–
PK243-01B	Unipolar	0.16		0.95	4	4.2	2.5		[2]	CMK243 □P	A-226
PK243-02A	Bipolar (Series)	0.2		0.28	13	48	60		[3]	–	–
PK243-02B	Unipolar	0.16		0.4	9.6	24	15		[2]	–	–
PK243-03A	Bipolar (Series)	0.2		0.22	17	77	84		[3]	–	–
PK243-03B	Unipolar	0.16		0.31	12	38.5	21		[2]	–	–
PK244-01A	Bipolar (Series)	0.33	54×10 ⁻⁷	0.85	5.6	6.6	12.8		[3]	–	–
PK244-01B	Unipolar	0.26		1.2	4	3.3	3.2		[2]	CMK244 □P	A-226
PK244-02A	Bipolar (Series)	0.33		0.57	8.6	15	26.8		[3]	–	–
PK244-02B	Unipolar	0.26		0.8	6	7.5	6.7		[2]	–	–
PK244-03A	Bipolar (Series)	0.33		0.28	17	60	120		[3]	–	–
PK244-03B	Unipolar	0.26		0.4	12	30	30		[2]	–	–
PK245-01A	Bipolar (Series)	0.43	68×10 ⁻⁷	0.85	5.6	6.6	11.2		[3]	–	–
PK245-01B	Unipolar	0.32		1.2	4	3.3	2.8		[2]	CMK245 □P	A-226
PK245-02A	Bipolar (Series)	0.43		0.57	8.6	15	28.4		[3]	–	–
PK245-02B	Unipolar	0.32		0.8	6	7.5	7.1		[2]	–	–
PK245-03A	Bipolar (Series)	0.43		0.28	17	60	100		[3]	–	–
PK245-03B	Unipolar	0.32		0.4	12	30	25		[2]	–	–

- **A** or **B** indicating motor shaft type is entered where the box □ is located within the product name.
- For the speed – torque characteristics of the motors in the table above, see the characteristics of the corresponding motor and driver package. If there is no corresponding package name, refer to the following characteristics.

Dimensions (Unit = mm)

Product Name	L1	L2	Mass kg
PK243-0□A	33	–	0.21
PK243-0□B		48	
PK244-0□A	39	–	0.27
PK244-0□B		54	
PK245-0□A	47	–	0.35
PK245-0□B		62	

- A number indicating the motor specification is entered where the box □ is located within the product name.

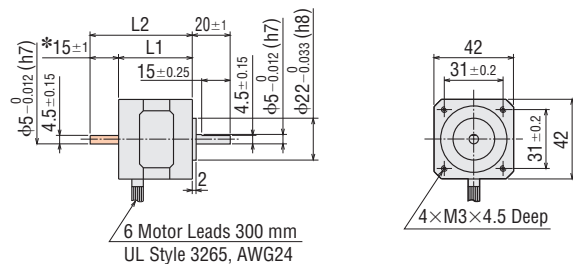

- *The length of the shaft flat on the double shaft model is 15±0.25.
- These dimensions are for double shaft models. For single shaft models, ignore the shaft in the shaded areas.

Step Angle 1.8° Frame Size 42 mm (6 lead wires)

Standard Type with Encoder

Specifications RoHS

Product Name	Connection Type	Maximum Holding Torque	Rotor Inertia	Rated Current	Voltage	Resistance per Phase	Inductance	Basic Step Angle	Wirings and Connections
Single Shaft		N-m	J: kg-m ²	A/Phase	VDC	Ω/Phase	mH/Phase		(See Page A-334)
PK243-01AR21-L	Bipolar (Series)	0.2	35×10 ⁻⁷	0.67	5.6	8.4	10	1.8°	③
PK243-01AR22-L	Unipolar	0.16		0.95	4	4.2	2.5		②
PK243-02AR21-L	Bipolar (Series)	0.2		0.28	13	48	60		③
PK243-02AR22-L	Unipolar	0.16		0.4	9.6	24	15		②
PK243-03AR21-L	Bipolar (Series)	0.2	54×10 ⁻⁷	0.22	17	77	84		③
PK243-03AR22-L	Unipolar	0.16		0.31	12	38.5	21		②
PK244-01AR21-L	Bipolar (Series)	0.33	54×10 ⁻⁷	0.85	5.6	6.6	12.8		③
PK244-01AR22-L	Unipolar	0.26		1.2	4	3.3	3.2		②
PK244-02AR21-L	Bipolar (Series)	0.33		0.57	8.6	15	26.8		③
PK244-02AR22-L	Unipolar	0.26		0.8	6	7.5	6.7		②
PK244-03AR21-L	Bipolar (Series)	0.33	68×10 ⁻⁷	0.28	17	60	120		③
PK244-03AR22-L	Unipolar	0.26		0.4	12	30	30		②
PK245-01AR21-L	Bipolar (Series)	0.43	68×10 ⁻⁷	0.85	5.6	6.6	11.2	③	
PK245-01AR22-L	Unipolar	0.32		1.2	4	3.3	2.8	②	
PK245-02AR21-L	Bipolar (Series)	0.43		0.57	8.6	15	28.4	③	
PK245-02AR22-L	Unipolar	0.32		0.8	6	7.5	7.1	②	
PK245-03AR21-L	Bipolar (Series)	0.43		0.28	17	60	100	③	
PK245-03AR22-L	Unipolar	0.32		0.4	12	30	25	②	

● "R21" and "AR" in the product name indicate the encoder resolution.

R21: 200 pulses/revolution AR: 400 pulses/revolution

● Encoder cable (0.6 m) is included.

R22もFuturaボールドにしました

Dimensions (Unit = mm)

Product Name	Motor Product Name	L1	L2	Mass kg
PK243-0□AR21-L	PK243-0□AR21	33	51.3	0.24
PK243-0□AR22-L	PK243-0□AR22	33	51.3	0.24
PK244-0□AR21-L	PK244-0□AR21	39	57.3	0.29
PK244-0□AR22-L	PK244-0□AR22	39	57.3	0.29
PK245-0□AR21-L	PK245-0□AR21	47	65.3	0.37
PK245-0□AR22-L	PK245-0□AR22	47	65.3	0.37

● A number indicating the motor specification is entered where the box □ is located within the product name.

● Applicable Encoder Connector

Connector Product Name	Manufacturer
640442-5	Tyco Electronics Japan G. K.
HEDS-8903 (For 3-Channel: 5-lead wires)	Avago Technologies Limited
2695 Series (Housing)	Molex
2759 Series (Contact)	

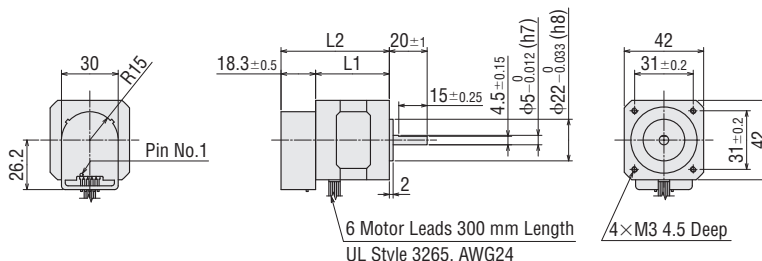

● Included

Encoder Cable

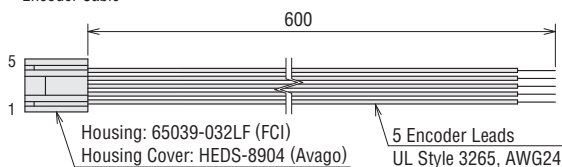

Encoder Specifications

→ Page A-336

28 mm

42 mm

50 mm

56.4 mm

60 mm

85 mm

90 mm

Speed – Torque Characteristics

PK243-01A/PK243-01B

PK243-01AR21-L/PK243-01AR22-L Bipolar (Series)

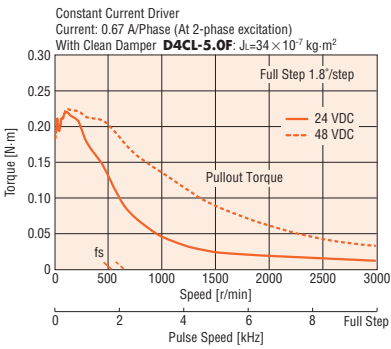

PK243-02A/PK243-02B

PK243-02AR21-L/PK243-02AR22-L Bipolar (Series)

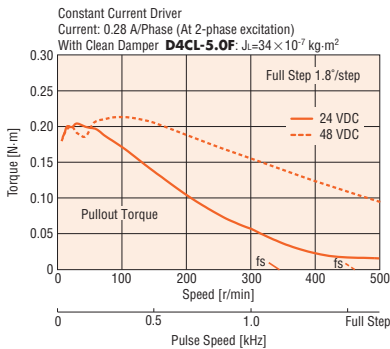

PK243-02A/PK243-02B

PK243-02AR21-L/PK243-02AR22-L Unipolar

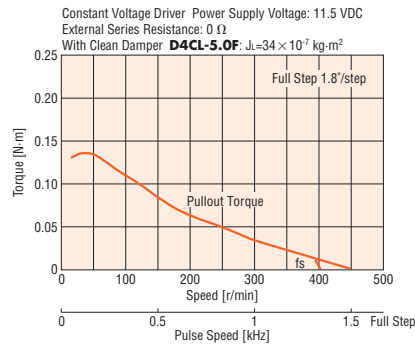

PK243-03A/PK243-03B

PK243-03AR21-L/PK243-03AR22-L Bipolar (Series)

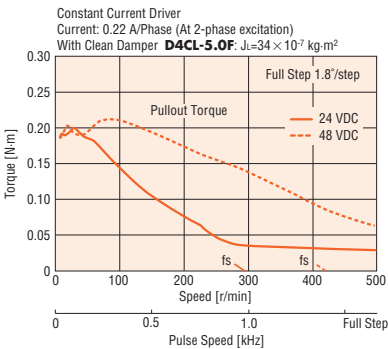

PK243-03A/PK243-03B

PK243-03AR21-L/PK243-03AR22-L Unipolar

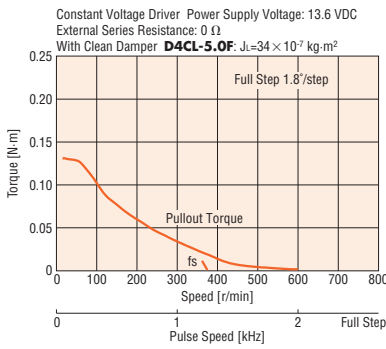

PK244-01A/PK244-01B

PK244-01AR21-L/PK244-01AR22-L Bipolar (Series)

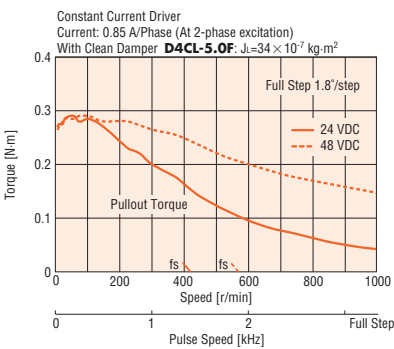

PK244-02A/PK244-02B

PK244-02AR21-L/PK244-02AR22-L Bipolar (Series)

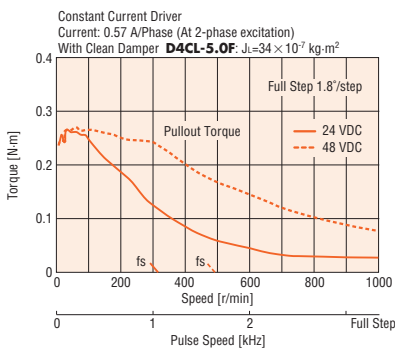

PK244-02A/PK244-02B

PK244-02AR21-L/PK244-02AR22-L Unipolar

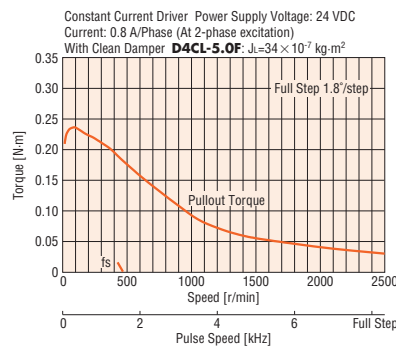

PK244-03A/PK244-03B

PK244-03AR21-L/PK244-03AR22-L Unipolar

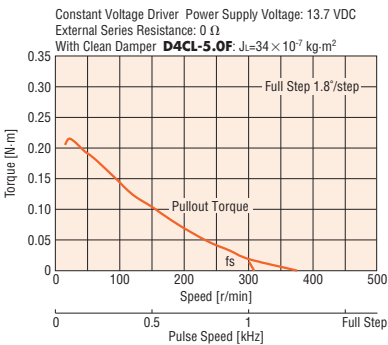

Note

Depending on the driving conditions, a considerable amount of heat may be generated by the motor. Be sure to keep the motor case temperature at 100°C or less.

PK245-01A/PK245-01B PK245-01AR21-L/PK245-01AR22-L Bipolar (Series)

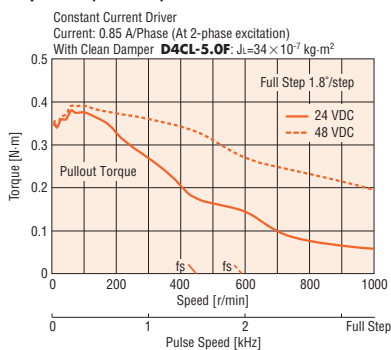

PK245-03A/PK245-03B PK245-03AR21-L/PK245-03AR22-L Unipolar

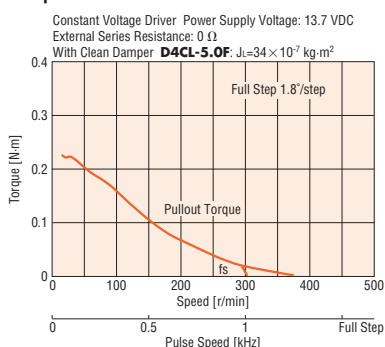

Note

● Depending on the driving conditions, a considerable amount of heat may be generated by the motor. Be sure to keep the motor case temperature at 100°C or less.

PK245-02A/PK245-02B PK245-02AR21-L/PK245-02AR22-L Bipolar (Series)

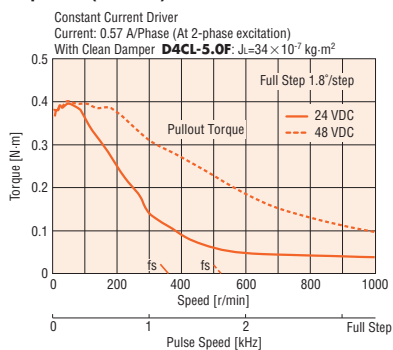

PK245-02A/PK245-02B PK245-02AR21-L/PK245-02AR22-L Unipolar

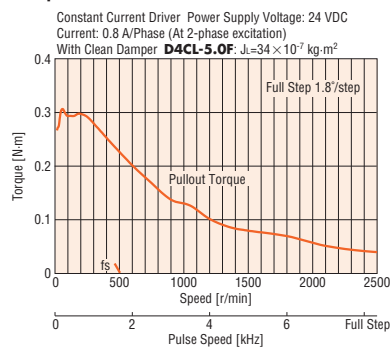

Introduction

0.36°/Geared
AR
AC Input Motor & Driver

0.72°/Geared
RK

0.36°/Geared
AR
AC Input Motor & Driver

0.36°/0.72°/
Geared
CRK
DC Input Motor & Driver

1.8°/Geared
RBK

0.9°/1.8°/Geared
CMK

0.72°
PK

1.8°/Geared
High-Torque
PKP
Motor Only

0.9°/1.8°/Geared
PK

Controllers
SG8030JY

Accessories

Step Angle 1.8° Frame Size 50 mm (6 lead wires)

Standard Type

Specifications RoHS

Product Name	Connection Type	Maximum Holding Torque	Rotor Inertia	Rated Current	Voltage	Resistance per Phase	Inductance	Basic Step Angle	Wirings and Connections (See Page A-334)	Corresponding Motor/Driver Package	Package Product Speed-Torque Characteristics	
										Product Name	Page	
Single Shaft												
Double Shaft		N·m	J: kg·m ²	A/Phase	VDC	Ω/Phase	mH/Phase					
PK256-02A	Bipolar (Series)	0.84	230×10 ⁻⁷	1.4	4.2	3	5.6	1.8°	[3]	–	–	
PK256-02B	Unipolar	0.6		2	3	1.5	1.4			CMK256 □P	A-226	
PK258-02A	Bipolar (Series)	1.56	420×10 ⁻⁷	1.4	6.7	4.8	11.5			[3]	–	–
PK258-02B	Unipolar	1.2		2	4.8	2.4	2.87			[2]	CMK258 □P	A-226

● **A** or **B** indicating motor shaft type is entered where the box □ is located within the product name.

● For the speed – torque characteristics of the motors in the table above, see the characteristics of the corresponding motor and driver package. If there is no corresponding package name, refer to the following characteristics.

Speed – Torque Characteristics

PK256-02A/PK256-02B

Bipolar (Series)

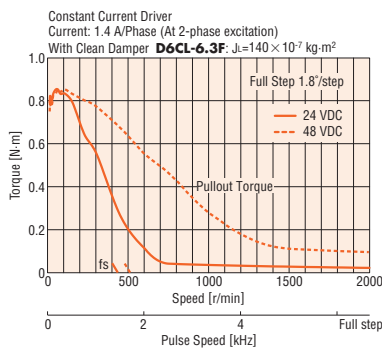

PK258-02A/PK258-02B

Bipolar (Series)

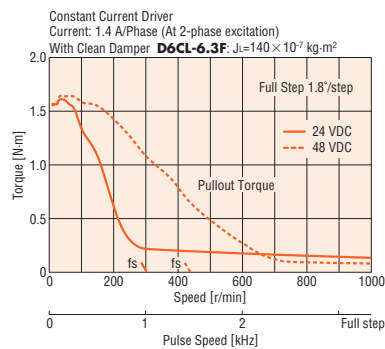

Note

● Depending on the driving conditions, a considerable amount of heat may be generated by the motor. Be sure to keep the motor case temperature at 100°C or less.

Dimensions (Unit = mm)

Product Name	L1	L2	Mass kg
PK256-02A	51.5	–	0.53
PK256-02B		67.5	
PK258-02A	81	–	0.89
PK258-02B		97	

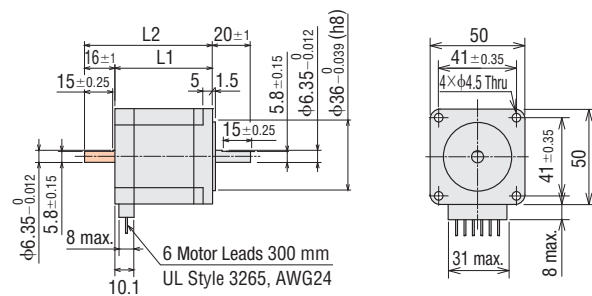

● These dimensions are for double shaft models.

For single shaft models, ignore the shaft in the shaded areas.

Step Angle 1.8° Frame Size 56.4 mm (4 lead wires)

Standard Type

Specifications RoHS

Product Name Single Shaft Double Shaft	Connection Type	Maximum Holding Torque N·m	Rotor Inertia J: kg·m ²	Rated Current A/Phase	Voltage VDC	Resistance per Phase Ω/Phase	Inductance mH/Phase	Basic Step Angle	Wirings and Connections (See Page A-334)	Corresponding Motor/Driver Package Product Name	Package Product Speed-Torque Characteristics Page
PK264D14A PK264D14B	Bipolar	0.48	120×10 ⁻⁷	1.4	3.92	2.8	5.6	1.8°	①	-	-
				2.8	1.96	0.7	1.4			-	-
				4.2	1.26	0.3	0.6			RBK264 □	A-200
PK266D14A PK266D14B		1.17	300×10 ⁻⁷	1.4	5.04	3.6	10			-	-
				2.8	2.52	0.9	2.5			-	-
				4.2	1.68	0.4	1.1			RBK266 □	A-200
PK268D14A PK268D14B		1.75	480×10 ⁻⁷	1.4	6.02	4.3	14.4			-	-
				2.8	3.16	1.13	3.6			-	-
				4.2	2.1	0.5	1.6			RBK268 □	A-200

● **A** or **B** indicating motor shaft type is entered where the box □ is located within the product name.

● For the speed – torque characteristics of the motors in the table above, see the characteristics of the corresponding motor and driver package. If there is no corresponding package name, refer to the following characteristics.

Speed – Torque Characteristics

PK264D14A/PK264D14B

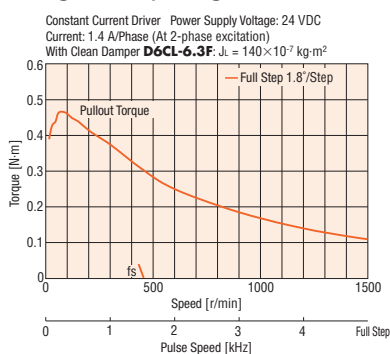

PK266D14A/PK266D14B

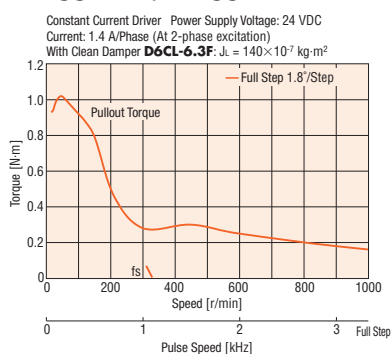

PK268D14A/PK268D14B

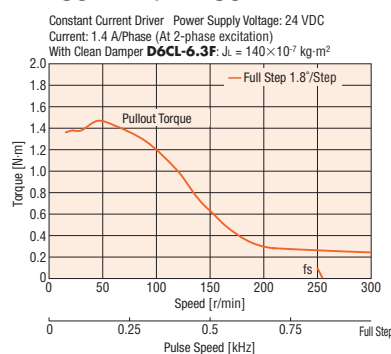

PK264D28A/PK264D28B

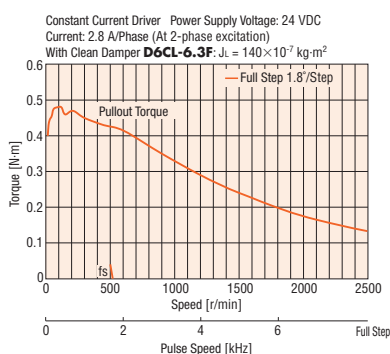

PK266D28A/PK266D28B

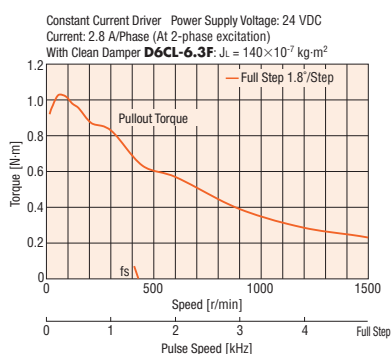

PK268D28A/PK268D28B

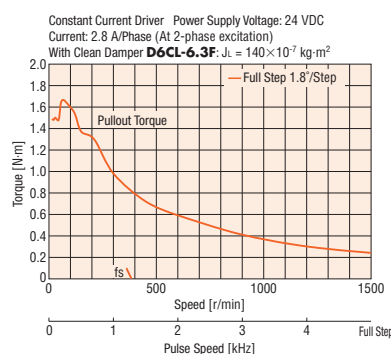

Note

● Depending on the driving conditions, a considerable amount of heat may be generated by the motor. Be sure to keep the motor case temperature at 100°C or less.

28 mm

42 mm

50 mm

56.4 mm

60 mm

85 mm

90 mm

Dimensions (Unit = mm)

Product Name	L1	L2	Mass kg
PK264D14A	39	-	0.45
PK264D28A			
PK264DA			
PK264D14B			
PK264D28B			
PK264DB	54	-	0.7
PK266D14A			
PK266D28A			
PK266DA			
PK266D14B			
PK266D28B	76	-	1.0
PK268D14A			
PK268D28A			
PK268DA			
PK268D14B			
PK268D28B	92		
PK268DB			

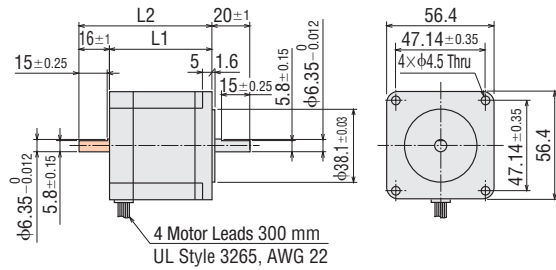

- These dimensions are for double shaft models.
For single shaft models, ignore the shaft in the shaded areas.

Step Angle 1.8° Frame Size 56.4 mm (6 or 8 lead wires)

Standard Type

Specifications RoHS

Product Name Single Shaft Double Shaft	Connection Type	Maximum Holding Torque N-m	Rotor Inertia J: kg-m ²	Rated Current A/Phase	Voltage VDC	Resistance per Phase Ω/Phase	Inductance mH/Phase	Basic Step Angle	Wirings and Connections (See Page A-334)	Corresponding Motor/Driver Package	Package Product Speed-Torque Characteristics	
										Product Name	Page	
PK264-01A PK264-01B	Bipolar (Series)	0.48	120×10 ⁻⁷	0.71	8.1	11.4	21.6	1.8°	[3]	-	-	
	Unipolar	0.39		1	5.7	5.7	5.4		[2]	-	-	
PK264-02A PK264-02B	Bipolar (Series)	0.48		1.4	3.9	2.8	5.6		[3]	-	-	
	Unipolar	0.39		2	2.8	1.4	1.4		[2]	CMK264□P	A-227	
PK264-03A PK264-03B	Bipolar (Series)	0.48		2.1	2.6	1.26	2.4		[3]	-	-	
	Unipolar	0.39		3	1.9	0.63	0.6		[2]	-	-	
PK264-E2.0A PK264-E2.0B	Bipolar (Parallel)	0.48		2.8	1.96	0.7	1.4		[6]	-	-	
	Bipolar (Series)	0.48		1.4	3.9	2.8	5.6		[5]	-	-	
Unipolar	0.39	2		2.8	1.4	1.4	[4]		-	-		
PK266-01A PK266-01B	Bipolar (Series)	1.17		300×10 ⁻⁷	0.71	11	14.8		40	[3]	-	-
	Unipolar	0.9			1	7.4	7.4		10	[2]	-	-
PK266-02A PK266-02B	Bipolar (Series)	1.17			1.4	5	3.6		10	[3]	-	-
	Unipolar	0.9	2		3.6	1.8	2.5	[2]	CMK266□P	A-227		
PK266-03A PK266-03B	Bipolar (Series)	1.17	2.1		3.2	1.5	4.4	[3]	-	-		
	Unipolar	0.9	3		2.3	0.75	1.1	[2]	-	-		
PK266-E2.0A PK266-E2.0B	Bipolar (Parallel)	1.17	2.8		2.52	0.9	2.5	[6]	-	-		
	Bipolar (Series)	1.17	1.4		5	3.6	10	[5]	-	-		
Unipolar	0.9	2	3.6		1.8	2.5	[4]	-	-			
PK268-01A PK268-01B	Bipolar (Series)	1.75	480×10 ⁻⁷		0.71	12	17.2	56	[3]	-	-	
	Unipolar	1.35			1	8.6	8.6	14	[2]	-	-	
PK268-02A PK268-02B	Bipolar (Series)	1.75			1.4	6.3	4.5	14.4	[3]	-	-	
	Unipolar	1.35		2	4.5	2.25	3.6	[2]	CMK268□P	A-227		
PK268-03A PK268-03B	Bipolar (Series)	1.75		2.1	4.2	2	6.4	[3]	-	-		
	Unipolar	1.35		3	3	1	1.6	[2]	-	-		
PK268-E2.0A PK268-E2.0B	Bipolar (Parallel)	1.75		2.8	3.16	1.13	3.6	[6]	-	-		
	Bipolar (Series)	1.75		1.4	6.3	4.5	14.4	[5]	-	-		
Unipolar	1.35	2		4.5	2.25	3.6	[4]	-	-			

● **A** or **B** indicating motor shaft type is entered where the box □ is located within the product name.

● For the speed – torque characteristics of the motors in the table above, see the characteristics of the corresponding motor and driver package. If there is no corresponding package name, refer to the following characteristics.

Dimensions (Unit = mm)

Product Name	L1	L2	Mass kg
PK264DA PK264-0□A PK264-E2.0A	39	-	0.45
PK264DB PK264-0□B PK264-E2.0B		55	
PK266DA PK266-0□A PK266-E2.0A	54	-	0.7
PK266DB PK266-0□B PK266-E2.0B		70	
PK268DA PK268-0□A PK268-E2.0A	76	-	1.0
PK268DB PK268-0□B PK268-E2.0B		92	

● A number indicating the motor specification is entered where the box □ is located within the product name.

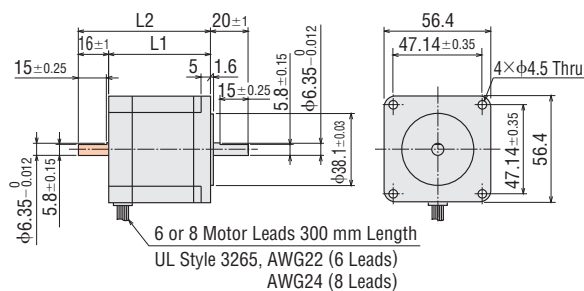

● These dimensions are for double shaft models.

For single shaft models, ignore the shaft in the shaded areas.

Step Angle 1.8° Frame Size 56.4 mm (6 or 8 lead wires)

Standard Type with Encoder

Specifications (RoHS)

Product Name	Connection Type	Maximum Holding Torque	Rotor Inertia	Rated Current	Voltage	Resistance per Phase	Inductance	Basic Step Angle	Wirings and Connections
Single Shaft		N·m	J: kg·m ²	A/Phase	VDC	Ω/Phase	mH/Phase		(See Page A-334)
PK264-01AR21-L	Bipolar (Series)	0.48	120×10 ⁻⁷	0.71	8.1	11.4	21.6	1.8°	③
PK264-01AR22-L	Unipolar	0.39		1	5.7	5.7	5.4		②
PK264-02AR21-L	Bipolar (Series)	0.48		1.4	3.9	2.8	5.6		③
PK264-02AR22-L	Unipolar	0.39		2	2.8	1.4	1.4		②
PK264-03AR21-L	Bipolar (Series)	0.48		2.1	2.6	1.26	2.4		③
PK264-03AR22-L	Unipolar	0.39		3	1.9	0.63	0.6		②
PK264EAR21-L	Bipolar (Parallel)	0.48	300×10 ⁻⁷	2.8	1.96	0.7	1.4		⑥
PK264EAR22-L	Bipolar (Series)	0.48		1.4	3.9	2.8	5.6		⑤
	Unipolar	0.39		2	2.8	1.4	1.4		④
PK266-01AR21-L	Bipolar (Series)	1.17	480×10 ⁻⁷	0.71	11	14.8	40		③
PK266-01AR22-L	Unipolar	0.9		1	7.4	7.4	10		②
PK266-02AR21-L	Bipolar (Series)	1.17		1.4	5	3.6	10		③
PK266-02AR22-L	Unipolar	0.9		2	3.6	1.8	2.5	②	
PK266-03AR21-L	Bipolar (Series)	1.17		2.1	3.2	1.5	4.4	③	
PK266-03AR22-L	Unipolar	0.9		3	2.3	0.75	1.1	②	
PK266EAR21-L	Bipolar (Parallel)	1.17	300×10 ⁻⁷	2.8	2.52	0.9	2.5	⑥	
PK266EAR22-L	Bipolar (Series)	1.17		1.4	5	3.6	10	⑤	
	Unipolar	0.9		2	3.6	1.8	2.5	④	
PK268-01AR21-L	Bipolar (Series)	1.75	480×10 ⁻⁷	0.71	12	17.2	56	③	
PK268-01AR22-L	Unipolar	1.35		1	8.6	8.6	14	②	
PK268-02AR21-L	Bipolar (Series)	1.75		1.4	6.3	4.5	14.4	③	
PK268-02AR22-L	Unipolar	1.35		2	4.5	2.25	3.6	②	
PK268-03AR21-L	Bipolar (Series)	1.75		2.1	4.2	2	6.4	③	
PK268-03AR22-L	Unipolar	1.35		3	3	1	1.6	②	
PK268EAR21-L	Bipolar (Parallel)	1.75	480×10 ⁻⁷	2.8	3.16	1.13	3.6	⑥	
PK268EAR22-L	Bipolar (Series)	1.75		1.4	6.3	4.5	14.4	⑤	
	Unipolar	1.35		2	4.5	2.25	3.6	④	

● "R21" and [] in the product name indicate the encoder resolution.

R21: 200 pulses/revolution [] 400 pulses/revolution

● Encoder cable (0.6 m) is included.

R22もFuturaボール
レドにしました

Dimensions (Unit = mm)

Product Name	Motor Product Name	L1	L2	Mass kg
PK264-0[]AR21-L	PK264-0[]AR21	39	57.3	0.47
PK264-0[]AR22-L	PK264-0[]AR22			
PK264EAR21-L	PK264EAR21			
PK264EAR22-L	PK264EAR22	54	72.3	0.72
PK266-0[]AR21-L	PK266-0[]AR21			
PK266-0[]AR22-L	PK266-0[]AR22			
PK266EAR21-L	PK266EAR21	76	94.3	1.02
PK266EAR22-L	PK266EAR22			
PK268-0[]AR21-L	PK268-0[]AR21			
PK268-0[]AR22-L	PK268-0[]AR22	76	94.3	1.02
PK268EAR21-L	PK268EAR21			
PK268EAR22-L	PK268EAR22			

● A number indicating the motor specification is entered where the box [] is located within the product name.

● Applicable Encoder Connector

Connector Product Name	Manufacturer
640442-5	Tyco Electronics Japan G. K.
HEDS-8903 (For 3-Channel: 5-lead wires)	Avago Technologies Limited
2695 Series (Housing)	Molex
2759 Series (Contact)	

● Included

Encoder Cable

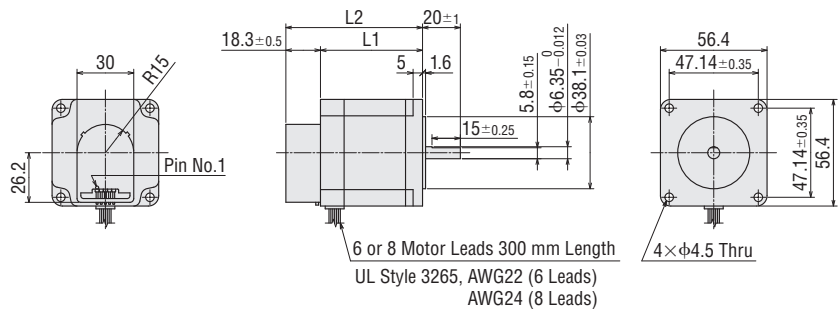
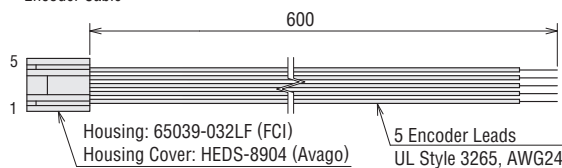

Encoder Specifications

→ Page A-336

Speed – Torque Characteristics

PK264-01A/PK264-01B PK264-01AR21-L/PK264-01AR22-L Bipolar (Series)

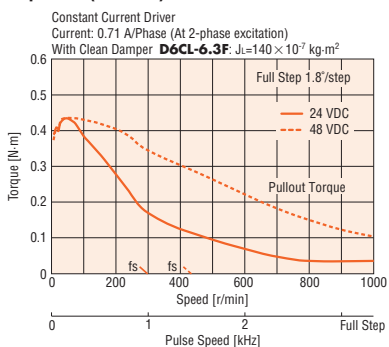

PK264-01A/PK264-01B PK264-01AR21-L/PK264-01AR22-L Unipolar

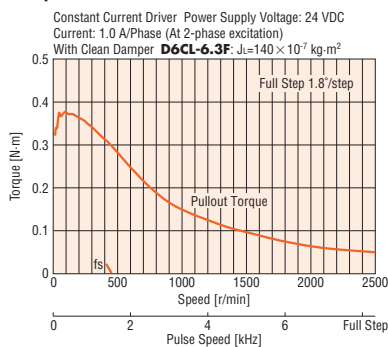

PK264-02A/PK264-02B PK264-02AR21-L/PK264-02AR22-L Bipolar (Series)

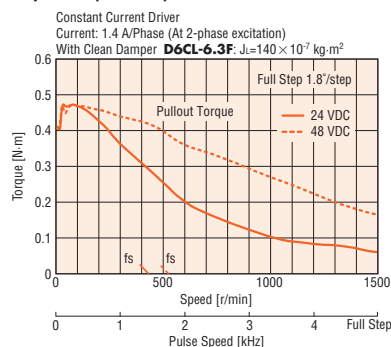

PK264-03A/PK264-03B PK264-03AR21-L/PK264-03AR22-L Bipolar (Series)

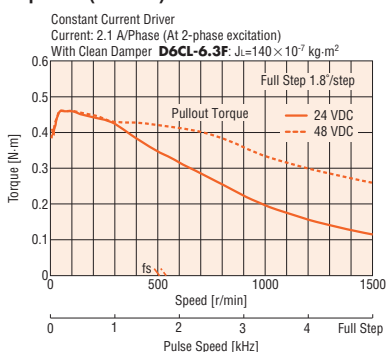

PK264-03A/PK264-03B PK264-03AR21-L/PK264-03AR22-L Unipolar

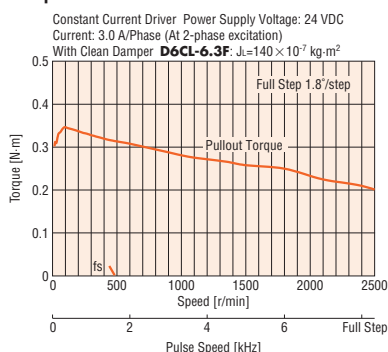

PK264-E2.0A/PK264-E2.0B PK264EAR21-L/PK264EAR22-L Bipolar (Parallel)

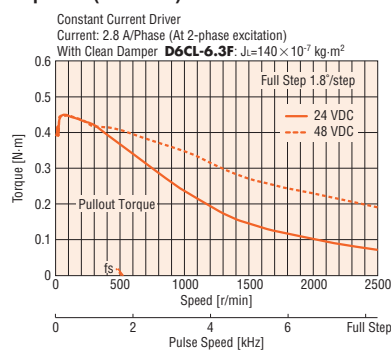

PK266-01A/PK266-01B PK266-01AR21-L/PK266-01AR22-L Bipolar (Series)

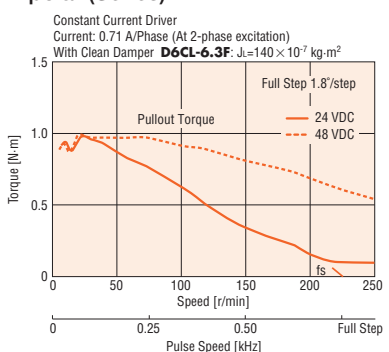

PK266-01A/PK266-01B PK266-01AR21-L/PK266-01AR22-L Unipolar

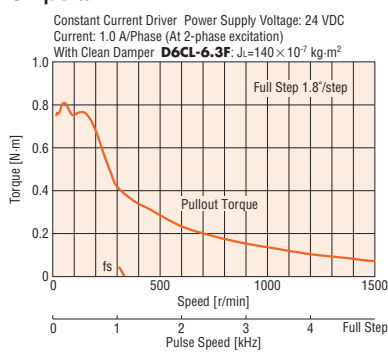

PK266-02A/PK266-02B PK266-02AR21-L/PK266-02AR22-L Bipolar (Series)

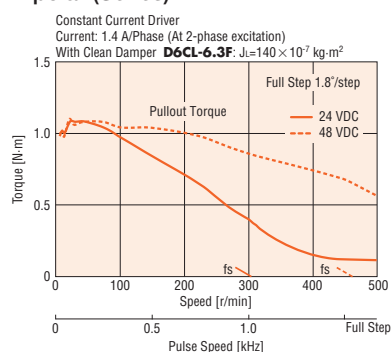

PK266-03A/PK266-03B PK266-03AR21-L/PK266-03AR22-L Bipolar (Series)

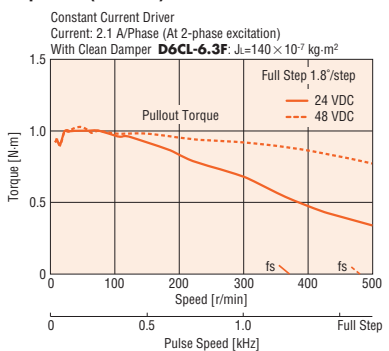

PK266-03A/PK266-03B PK266-03AR21-L/PK266-03AR22-L Unipolar

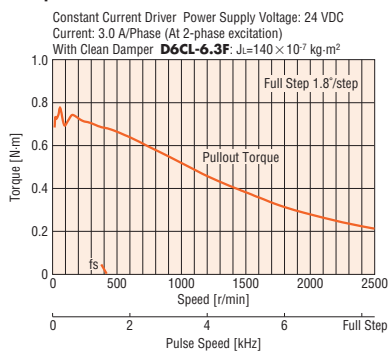

PK266-E2.0A/PK266-E2.0B PK266EAR21-L/PK266EAR22-L Bipolar (Parallel)

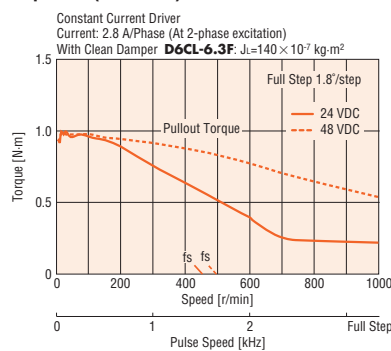

Note

● Depending on the driving conditions, a considerable amount of heat may be generated by the motor. Be sure to keep the motor case temperature at 100°C or less.

28 mm

42 mm

50 mm

56.4 mm

60 mm

85 mm

90 mm

Speed – Torque Characteristics

PK268-01A/PK268-01B

PK268-01AR21-L/PK268-01AR22-L Bipolar (Series)

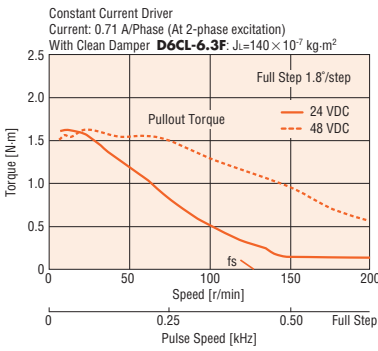

PK268-01A/PK268-01B

PK268-01AR21-L/PK268-01AR22-L Unipolar

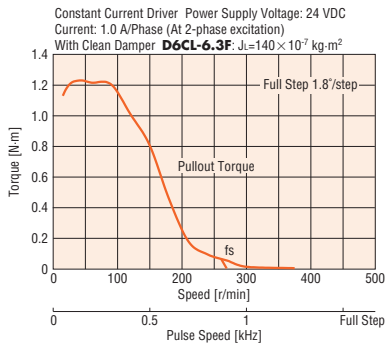

PK268-02A/PK268-02B

PK268-02AR21-L/PK268-02AR22-L Bipolar (Series)

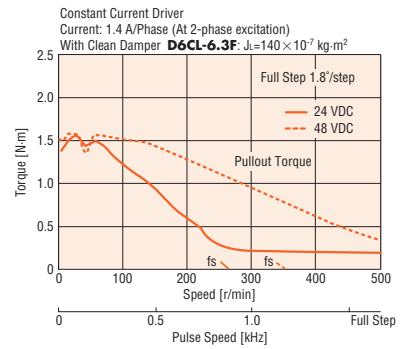

PK268-03A/PK268-03B

PK268-03AR21-L/PK268-03AR22-L Bipolar (Series)

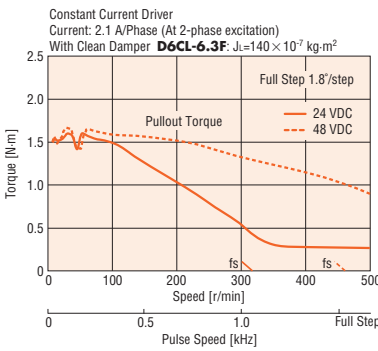

PK268-03A/PK268-03B

PK268-03AR21-L/PK268-03AR22-L Unipolar

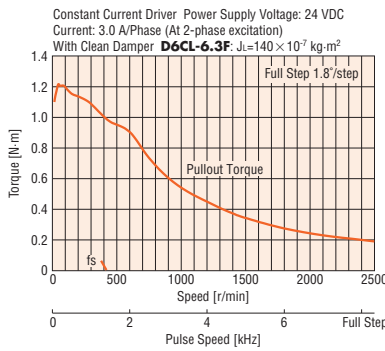

PK268-E2.0A/PK268-E2.0B

PK268EAR21-L/PK268EAR22-L Bipolar (Parallel)

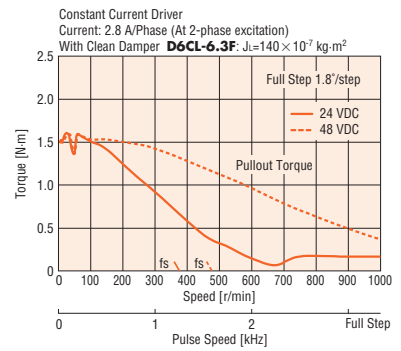

Note

● Depending on the driving conditions, a considerable amount of heat may be generated by the motor. Be sure to keep the motor case temperature at 100°C or less.

Step Angle 1.8° Frame Size 85 mm (4 lead wires)

Standard Type

Specifications RoHS

Product Name	Connection Type	Maximum Holding Torque	Rotor Inertia	Rated Current	Voltage	Resistance per Phase	Inductance	Basic Step Angle	Wirings and Connections	Corresponding Motor/Driver Package	Package Product Speed-Torque Characteristics
Single Shaft Double Shaft		N·m	J: kg·m ²	A/Phase	VDC	Ω/Phase	mH/Phase		(See Page A-334)	Product Name	Page
PK296DA PK296DB	Bipolar	2.2	1400×10 ⁻⁷	4.5	1.1	0.24	1.5	1.8°	①	RBK296 □	A-201
PK299DA PK299DB		4.4	2700×10 ⁻⁷		1.5	0.33	2.5			RBK299 □	A-201
PK2913DA PK2913DB		6.6	4000×10 ⁻⁷		2.2	0.49	4.2			RBK2913 □	A-201

● **A** or **B** indicating motor shaft type is entered where the box □ is located within the product name.

● For the speed – torque characteristics of the motors in the table above, see the characteristics of the corresponding motor and driver package. If there is no corresponding package name, refer to the following characteristics.

Dimensions (Unit = mm)

Product Name	L1	L2	Mass kg
PK296DA	66	–	1.7
PK296DB		100	
PK299DA	96	–	2.8
PK299DB		130	
PK2913DA	126	–	3.8
PK2913DB		160	

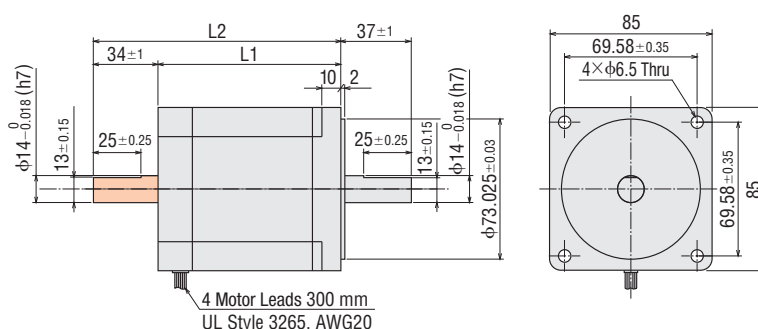

● These dimensions are for double shaft models. For single shaft models, ignore the shaft in the shaded areas.

Step Angle 1.8° Frame Size 85 mm (8 lead wires)

Standard Type

Specifications RoHS

Product Name	Connection Type	Maximum Holding Torque	Rotor Inertia	Rated Current	Voltage	Resistance per Phase	Inductance	Basic Step Angle	Wirings and Connections
		N·m	J: kg·m ²	A/Phase	VDC	Ω/Phase	mH/Phase		(See Page A-334)
PK296-E4.5A PK296-E4.5B	Bipolar (Parallel)	3.1	1400×10 ⁻⁷	6.3	1.4	0.24	1.5	1.8°	6
	Bipolar (Series)	3.1		3.18	2.8	0.96	6.0		5
	Unipolar	2.2		4.5	2	0.48	1.5		4
PK299-E4.5A PK299-E4.5B	Bipolar (Parallel)	6.2	2700×10 ⁻⁷	6.3	1.9	0.33	2.5		6
	Bipolar (Series)	6.2		3.18	3.9	1.32	10.0		5
	Unipolar	4.4		4.5	2.8	0.66	2.5		4
PK2913-E4.0A PK2913-E4.0B	Bipolar (Parallel)	9.3	4000×10 ⁻⁷	5.6	2.6	0.49	4.2		6
	Bipolar (Series)	9.3		2.8	5.3	1.94	16.8		5
	Unipolar	6.6		4	3.8	0.97	4.2		4

● **A** or **B** indicating motor shaft type is entered where the box is located within the product name.

● For the speed – torque characteristics of the motors in the table above, see the characteristics of the corresponding motor and driver package. If there is no corresponding package name, refer to the following characteristics.

Speed – Torque Characteristics

PK296-E4.5A/PK296-E4.5B

Bipolar (Parallel)

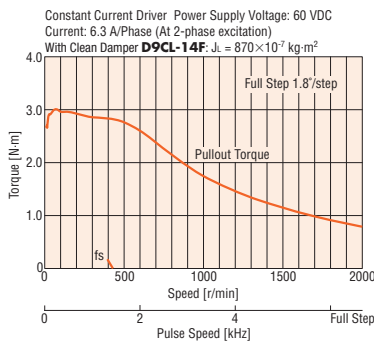

PK296-E4.5A/PK296-E4.5B

Bipolar (Series)

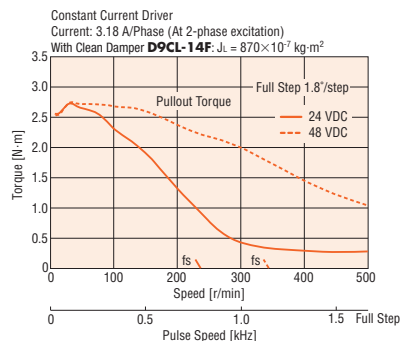

PK296-E4.5A/PK296-E4.5B

Unipolar

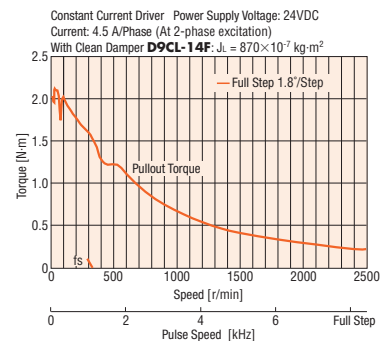

PK299-E4.5A/PK299-E4.5B

Bipolar (Parallel)

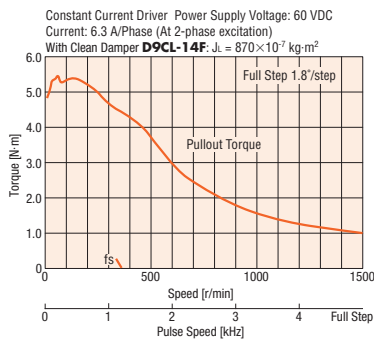

PK299-E4.5A/PK299-E4.5B

Bipolar (Series)

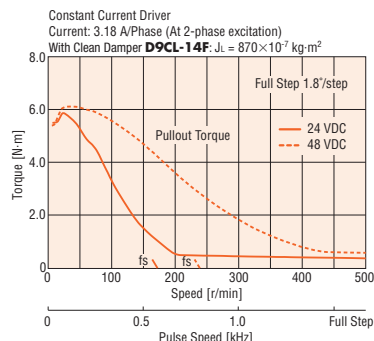

PK299-E4.5A/PK299-E4.5B

Unipolar

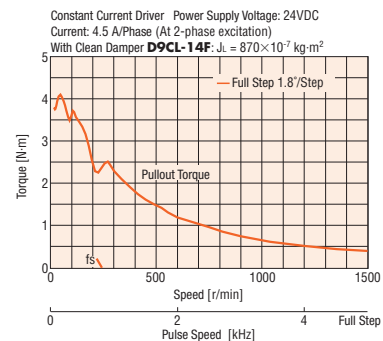

PK2913-E4.0A/PK2913-E4.0B

Bipolar (Parallel)

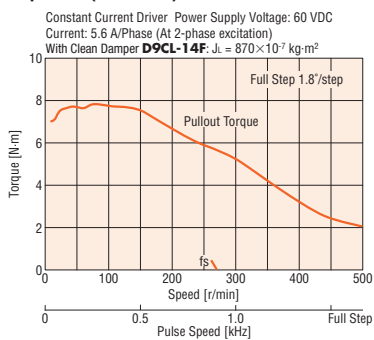

PK2913-E4.0A/PK2913-E4.0B

Bipolar (Series)

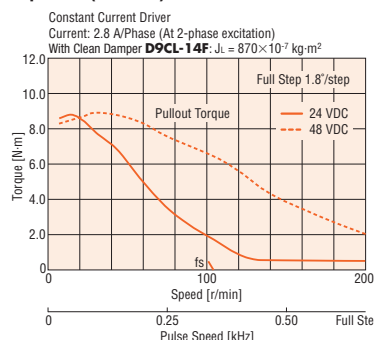

PK2913-E4.0A/PK2913-E4.0B

Unipolar

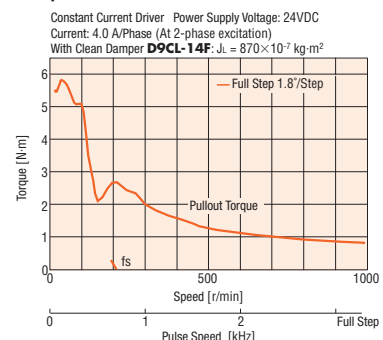

Note

● Depending on the driving conditions, a considerable amount of heat may be generated by the motor. Be sure to keep the motor case temperature at 100°C or less.

Dimensions (Unit = mm)

Product Name	L1	L2	Mass kg
PK296-E4.5A	66	-	1.7
PK296-E4.5B		100	
PK299-E4.5A	96	-	2.8
PK299-E4.5B		130	
PK2913-E4.0A	126	-	3.8
PK2913-E4.0B		160	

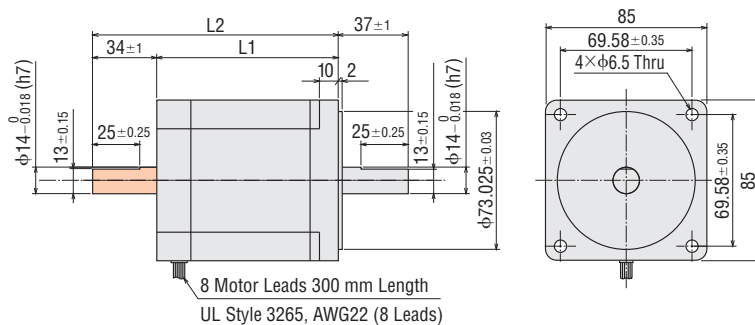

● These dimensions are for double shaft models. For single shaft models, ignore the shaft in the shaded areas.

Introduction

0.36°/Geared
AC Input Motor & Driver
AR
0.72°/Geared
RK

0.36°/Geared
AR
0.72°/Geared
CRK

0.36°/0.72°/Geared
DC Input Motor & Driver
CRK
1.8°/Geared
RBK

0.9°/1.8°/Geared
CMK

0.72°
PK

1.8°/Geared
High-Torque
PKP
Motor Only

0.9°/1.8°/Geared
PK

Controllers
SG8030JY

Accessories

Step Angle 1.8° Frame Size 56.4 mm (4 lead wires)

Standard Type with Cable

Specifications



Product Name	Connection Type	Maximum Holding Torque	Rotor Inertia	Rated Current	Voltage	Resistance per Phase	Inductance	Basic Step Angle	Wirings and Connections
Single Shaft		N·m	J: kg·m ²	A/Phase	VDC	Ω/Phase	mH/Phase		(See Page A-334)
PK264DW	Bipolar	0.48	120×10 ⁻⁷	4.2	1.26	0.3	0.6	1.8°	
PK266DW		1.17	300×10 ⁻⁷		1.68	0.4	1.1		
PK268DW		1.75	480×10 ⁻⁷		2.1	0.5	1.6		

● Degree of Protection: IP54 (Excluding the motor mounting surface)

Speed – Torque Characteristics

PK264DW

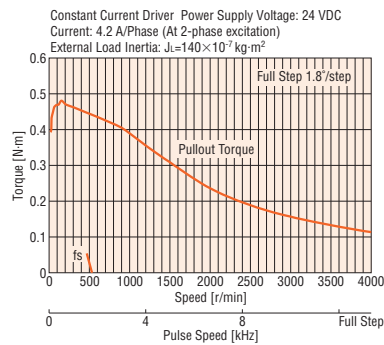

PK266DW

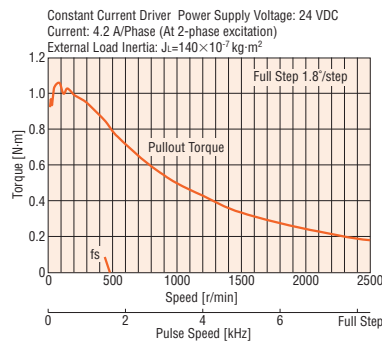

PK268DW

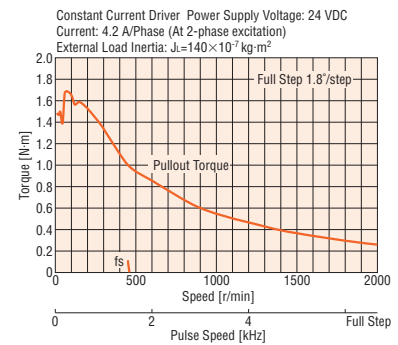

Note

● Depending on the driving conditions, a considerable amount of heat may be generated by the motor. Be sure to keep the motor case temperature at 100°C or less.

Dimensions (Unit = mm)

Product Name	L	Mass kg
PK264DW	47	0.55
PK266DW	62	0.8
PK268DW	84	1.15

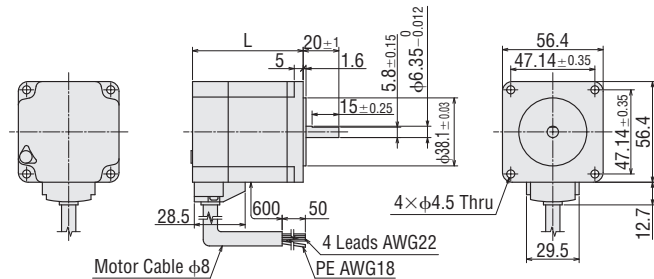

Step Angle 1.8° Frame Size 85 mm (4 lead wires)

Standard Type with Cable

Specifications RoHS



Product Name	Connection Type	Maximum Holding Torque	Rotor Inertia	Rated Current	Voltage	Resistance per Phase	Inductance	Basic Step Angle	Wirings and Connections
Single Shaft		N·m	J: kg·m ²	A/Phase	VDC	Ω/Phase	mH/Phase		(See Page A-334)
PK296DW	Bipolar	3.1	1400×10 ⁻⁷	6.3	1.4	0.24	1.5	1.8°	①
PK299DW		6.2	2700×10 ⁻⁷	6.3	1.9	0.33	2.5		
PK2913DW		9.3	4000×10 ⁻⁷	5.6	2.6	0.49	4.2		

① Degree of Protection: IP54 (Excluding the motor mounting surface)

Speed – Torque Characteristics

PK296DW

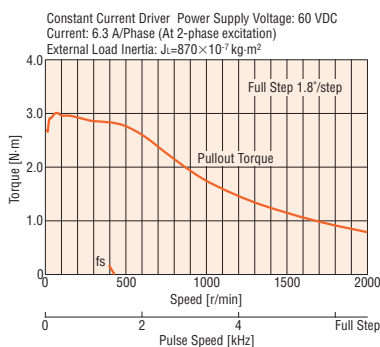

PK299DW

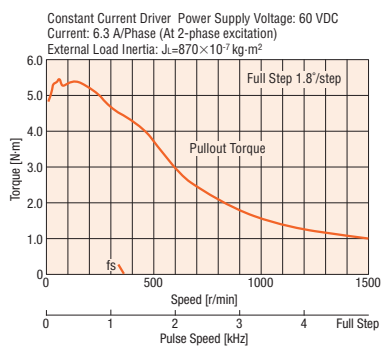

PK2913DW

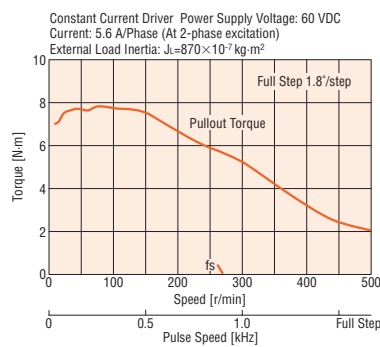

Note

Depending on the driving conditions, a considerable amount of heat may be generated by the motor. Be sure to keep the motor case temperature at 100°C or less.

Dimensions (Unit = mm)

Product Name	L	Mass kg
PK296DW	75.5	2.0
PK299DW	105.5	3.1
PK2913DW	135.5	4.2

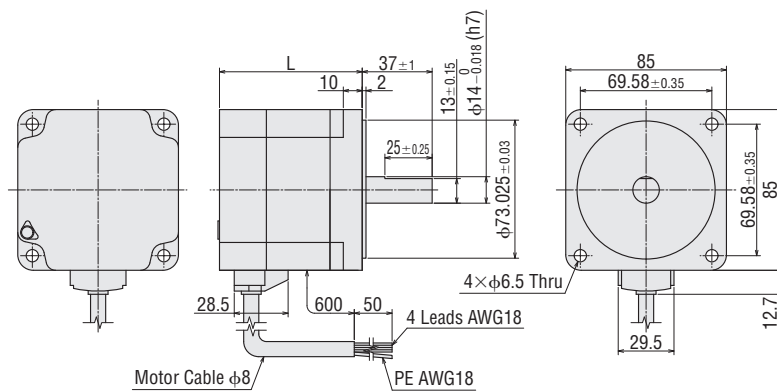

Step Angle 1.8° Frame Size 56.4 mm (4 lead wires)

Standard Type with Terminal Box

Specifications RoHS



Product Name	Connection Type	Maximum Holding Torque	Rotor Inertia	Rated Current	Voltage	Resistance per Phase	Inductance	Basic Step Angle	Wirings and Connections (See Page A-334)	Corresponding Motor/Driver Package	Package Product Speed-Torque Characteristics
Single Shaft		N·m	J: kg·m ²	A/Phase	VDC	Ω/Phase	mH/Phase			Product Name	Page
PK264DAT	Bipolar	0.48	120×10 ⁻⁷	2.8	1.96	0.7	1.4	1.8°	7	—	—
PK264D1T				4.2	1.26	0.3	0.6			RBK264T	A-202
PK266DAT		1.17	300×10 ⁻⁷	2.8	2.52	0.9	2.5			—	—
PK266D1T				4.2	1.68	0.4	1.1			RBK266T	A-202
PK268DAT		1.75	480×10 ⁻⁷	2.8	3.16	1.13	3.6			—	—
PK268D1T				4.2	2.1	0.5	1.6			RBK268T	A-202

- For the speed – torque characteristics of the motors in the table above, see the characteristics of the corresponding motor and driver package. If there is no corresponding package name, refer to the following characteristics.
- Degree of Protection: IP54 (Excluding shaft penetration)

Speed – Torque Characteristics

PK264DAT

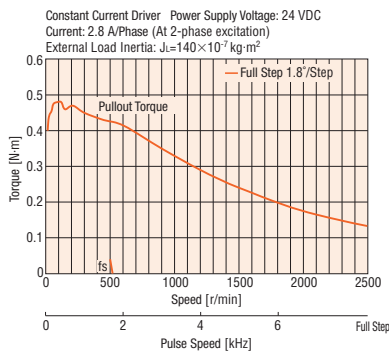

PK266DAT

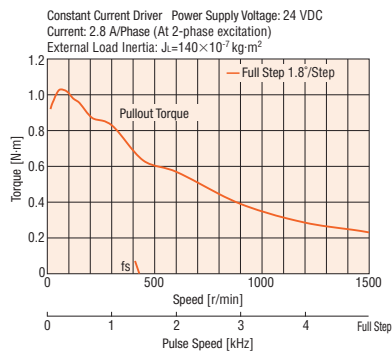

PK268DAT

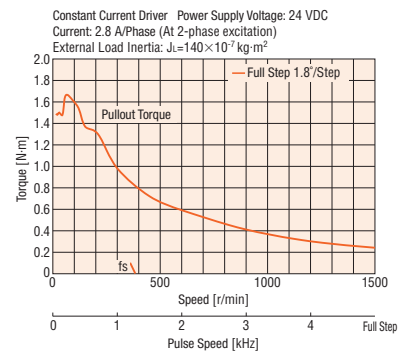

Note

- Depending on the driving conditions, a considerable amount of heat may be generated by the motor. Be sure to keep the motor case temperature at 100°C or less.

Dimensions (Unit = mm)

Product Name	L	Mass kg
PK264DAT PK264D1T	83	0.6
PK266DAT PK266D1T	98	0.9
PK268DAT PK268D1T	120	1.2

- Use cable (VCT) with a diameter of φ7~φ13 mm. Accessory connection cable (with protective earth wire, sold separately) is available. → Page A-358

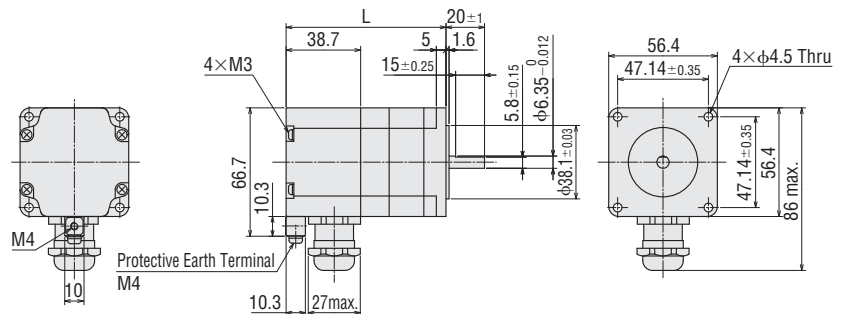













Step Angle 1.8° Frame Size 85 mm (4 or 8 lead wires)

Standard Type with Terminal Box

Specifications



Product Name	Connection Type	Maximum Holding Torque	Rotor Inertia	Rated Current	Voltage	Resistance per Phase	Inductance	Basic Step Angle	Wirings and Connections	Corresponding Motor/Driver Package	Package Product Speed-Torque Characteristics
Single Shaft		N·m	J: kg·m ²	A/Phase	VDC	Ω/Phase	mH/Phase		(See Page A-334)	Product Name	Page
PK296DT	Bipolar	2.2	1400×10 ⁻⁷	4.5	1.1	0.24	1.5	1.8°		RBK296T	A-203
	Bipolar (Parallel)	3.1		6.3	1.4	0.24	1.5				
PK296EAT	Bipolar (Series)	3.1		3.18	2.8	0.96	6.0				
	Unipolar	2.2		4.5	2	0.48	1.5				
PK299DT	Bipolar	4.4	2700×10 ⁻⁷	4.5	1.5	0.33	2.5			RBK299T	A-203
	Bipolar (Parallel)	6.2		6.3	1.9	0.33	2.5				
PK299EAT	Bipolar (Series)	6.2		3.18	3.9	1.32	10.0				
	Unipolar	4.4		4.5	2.8	0.66	2.5				
PK2913DT	Bipolar	6.6	4000×10 ⁻⁷	4.5	2.2	0.49	4.2			RBK2913T	A-203
PK2913EAT	Bipolar (Parallel)	9.3		5.6	2.6	0.49	4.2				
	Bipolar (Series)	9.3		2.8	5.3	1.94	16.8				
Unipolar	6.6	4		3.8	0.97	4.2					

- For the speed – torque characteristics of the motors in the table above, see the characteristics of the corresponding motor and driver package. If there is no corresponding package name, refer to the following characteristics.
- Degree of Protection: IP54 (Excluding shaft penetration)

Speed – Torque Characteristics

PK296EAT

Bipolar (Parallel)

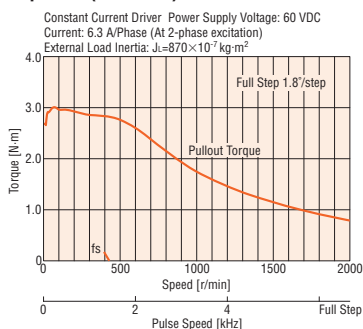

PK296EAT

Bipolar (Series)

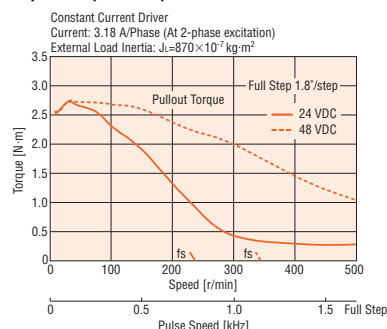

PK296EAT

Unipolar

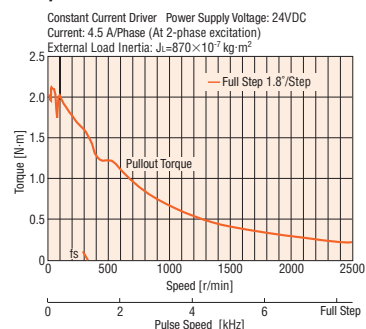

PK299EAT

Bipolar (Parallel)

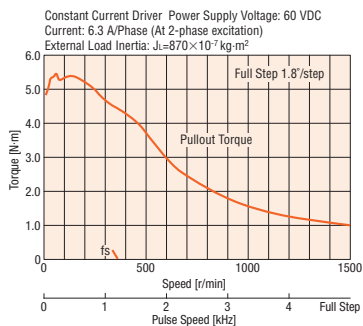

PK299EAT

Bipolar (Series)

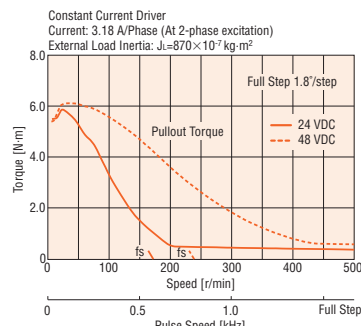

PK299EAT

Unipolar

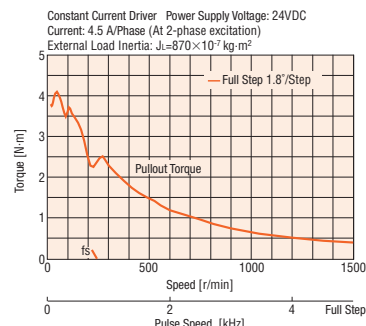

PK2913EAT

Bipolar (Parallel)

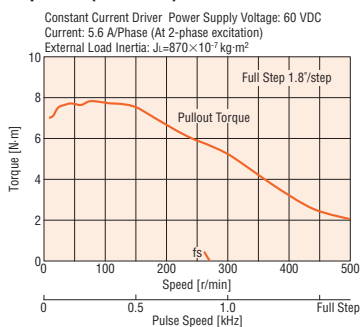

PK2913EAT

Bipolar (Series)

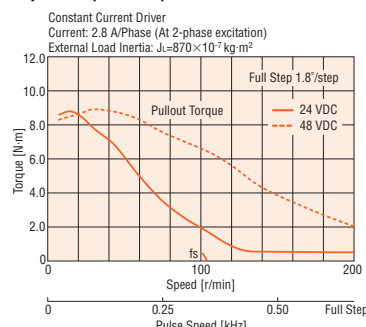

PK2913EAT

Unipolar

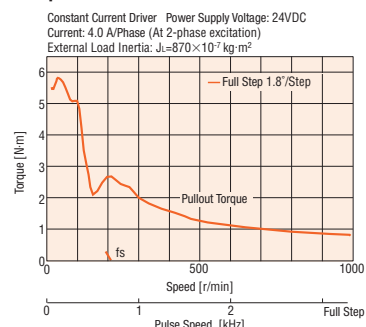

Note

- Depending on the driving conditions, a considerable amount of heat may be generated by the motor. Be sure to keep the motor case temperature at 100°C or less.

Introduction

AC Input Motor & Driver

0.36°/Geared AR Q_{500P}

0.72°/Geared RK Q_{500P}

0.36°/Geared AR Q_{500P}

DC Input Motor & Driver

0.36°/0.72°/Geared CRK Q_{500P}

1.8°/Geared RBK Q_{500P}

0.9°/1.8°/Geared CMK Q_{500P}

0.72°/Geared PK Q_{500P}

1.8°/Geared High-Torque PKD Q_{500P}

0.9°/1.8°/Geared PK Q_{500P}

Controllers SG80301Y

Accessories

□28 mm

□42 mm

□50 mm

□56.4 mm

□60 mm

□85 mm

□90 mm

Dimensions (Unit = mm)

Product Name	L	Mass kg
PK296DT PK296EAT	110	2.1
PK299DT PK299EAT	140	3.2
PK2913DT PK2913EAT	170	4.3

● Use cable (VCT) with a diameter of $\phi 7 \sim \phi 13$ mm. Accessory connection cable (with protective earth wire, sold separately) is available → Page A-358

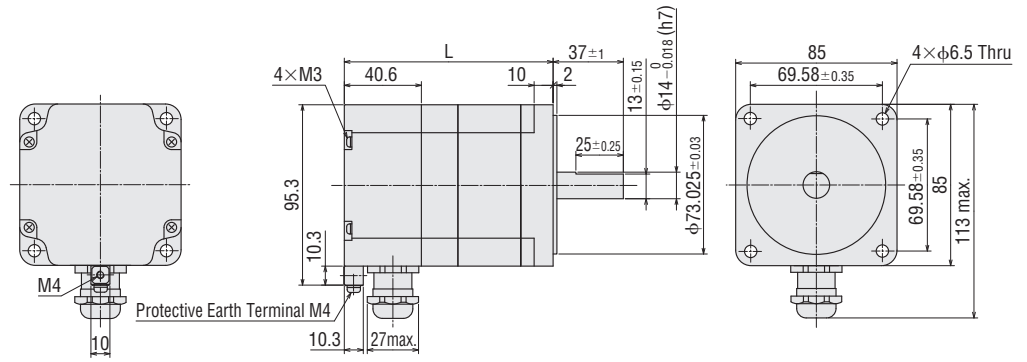

SH Geared Type Frame Size 42 mm (6 lead wires)

Specifications RoHS

Motor Specifications

Product Name Single Shaft Double Shaft	Connection Type	Rotor Inertia J: kg·m ²	Rated Current A/Phase	Voltage VDC	Resistance per Phase Ω/Phase	Inductance mH/Phase	Wirings and Connections (See Page A-334)	Corresponding Motor/Driver Packages	Package Product Speed-Torque Characteristics Page
PK243A1-SG <input type="checkbox"/>	Bipolar (Series)	35×10 ⁻⁷	0.67	5.6	8.4	10	<input type="checkbox"/> 3	—	—
PK243B1-SG <input type="checkbox"/>	Unipolar		0.95	4	4.2	2.5	<input type="checkbox"/> 2	CMK243 <input type="checkbox"/> P-SG <input type="checkbox"/>	A-229

- A number indicating the gear ratio is entered where the box is located within the product name.
Either **A** or **B** indicating the motor shaft type is entered where the box is located within the product name.
- For the speed – torque characteristics of the motors in the table above, see the characteristics of the corresponding motor and driver package. If there is no corresponding package name, refer to the following characteristics.
- Backlash value is approximately 1 to 2'.

Note

- The rotation direction of the motor and that of the gear output shaft are the same for the gear ratios 3.6, 7.2, 9, 10, 50 and 100. It is the opposite for 18 and 36 gear ratios.

Gearmotor Specifications

Product Name Single Shaft Double Shaft	Maximum Holding Torque N·m	Basic Step Angle	Gear Ratio	Permissible Torque N·m	Permissible Speed Range r/min
PK243A1-SG3.6 PK243B1-SG3.6	0.2	0.5°	3.6	0.2	0~500
PK243A1-SG7.2 PK243B1-SG7.2	0.4	0.25°	7.2	0.4	0~250
PK243A1-SG9 PK243B1-SG9	0.5	0.2°	9	0.5	0~200
PK243A1-SG10 PK243B1-SG10	0.56	0.18°	10	0.56	0~180
PK243A1-SG18 PK243B1-SG18	0.8	0.1°	18	0.8	0~100
PK243A1-SG36 PK243B1-SG36		0.05°	36		0~50
PK243A1-SG50 PK243B1-SG50		0.036°	50		0~36
PK243A1-SG100 PK243B1-SG100		0.018°	100		0~18

- Maximum holding torque is the same regardless of the connection type due to the permissible torque limit of the gearhead.

Speed – Torque Characteristics

PK243A1-SG/PK243B1-SG

Bipolar (Series) 24 VDC

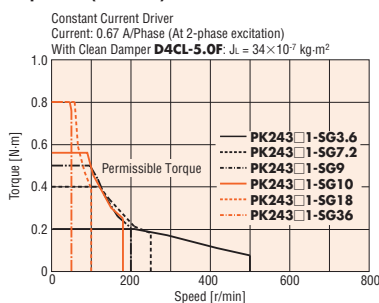

PK243A1-SG/PK243B1-SG

Bipolar (Series) 48 VDC

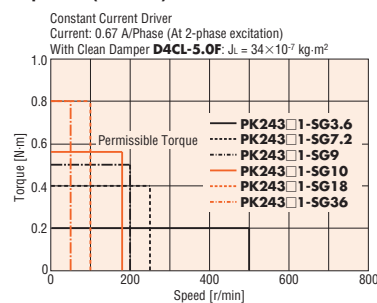

Note

- Depending on the driving conditions, a considerable amount of heat may be generated by the motor. Be sure to keep the motor case temperature at 100°C or less.

Dimensions

→ Page A-326

SH Geared Type Frame Size 60 mm (6 or 8 lead wires)

Specifications RoHS

● Motor Specifications

Product Name	Connection Type	Rotor Inertia	Rated Current	Voltage	Resistance per Phase	Inductance	Wirings and Connections	Corresponding Motor/Driver Packages	Package Product Speed-Torque Characteristics Page
Single Shaft			A/Phase	VDC	Ω/Phase	mH/Phase	(See Page A-334)		
Double Shaft		J: kg·m ²							
PK264AE-SG <input type="checkbox"/> PK264BE-SG <input type="checkbox"/>	Bipolar (Parallel)	120×10 ⁻⁷	2.8	1.96	0.7	1.4	6	—	—
	Bipolar (Series)		1.4	3.9	2.8	5.6	5	—	—
	Unipolar		2	2.8	1.4	1.4	4	—	—
PK264A2-SG <input type="checkbox"/> PK264B2-SG <input type="checkbox"/>	Bipolar (Parallel)	120×10 ⁻⁷	1.4	3.9	2.8	5.6	3	—	—
	Unipolar		2	2.8	1.4	1.4	2	CMK264 <input type="checkbox"/> P-SG <input type="checkbox"/>	A-231

● A number indicating the gear ratio is entered where the box is located within the product name.

Either **A** or **B** indicating the motor shaft type is entered where the box is located within the product name.

● For the speed – torque characteristics of the motors in the table above, see the characteristics of the corresponding motor and driver package. If there is no corresponding package name, refer to the following characteristics.

● Backlash value is approximately 1 to 2°.

Note

● The rotation direction of the motor and that of the gear output shaft are the same for the gear ratios 3.6, 7.2, 9, 10, 50 and 100. It is the opposite for 18 and 36 gear ratios.

● Gearmotor Specifications

Product Name	Maximum Holding Torque	Basic Step Angle	Gear Ratio	Permissible Torque	Permissible Speed Range
Single Shaft				N-m	r/min
Double Shaft	N-m				
PK264AE-SG3.6 , PK264A2-SG3.6 PK264BE-SG3.6 , PK264B2-SG3.6	1	0.5°	3.6	1	0~500
PK264AE-SG7.2 , PK264A2-SG7.2 PK264BE-SG7.2 , PK264B2-SG7.2	2	0.25°	7.2	2	0~250
PK264AE-SG9 , PK264A2-SG9 PK264BE-SG9 , PK264B2-SG9	2.5	0.2°	9	2.5	0~200
PK264AE-SG10 , PK264A2-SG10 PK264BE-SG10 , PK264B2-SG10	2.7	0.18°	10	2.7	0~180
PK264AE-SG18 , PK264A2-SG18 PK264BE-SG18 , PK264B2-SG18	3	0.1°	18	3	0~100
PK264AE-SG36 , PK264A2-SG36 PK264BE-SG36 , PK264B2-SG36	4	0.05°	36	4	0~50
		0.036°	50		0~36
PK264A2-SG50 PK264B2-SG50	4	0.018°	100		0~18
PK264A2-SG100 PK264B2-SG100					

● Maximum holding torque is the same regardless of the connection type due to the permissible torque limit of the gearhead.

Speed – Torque Characteristics

PK264AE-SG / PK264BE-SG

Bipolar (Series) 24 VDC

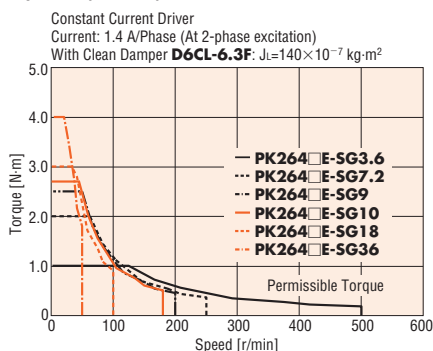

PK264AE-SG / PK264BE-SG

Bipolar (Series) 48 VDC

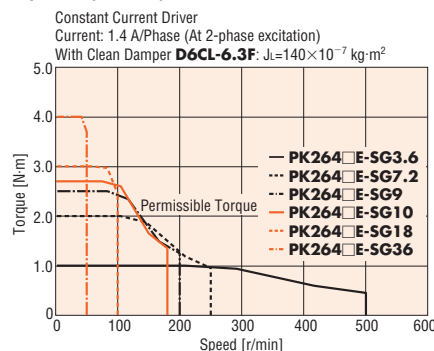

PK264AE-SG / PK264BE-SG

Unipolar 24 VDC

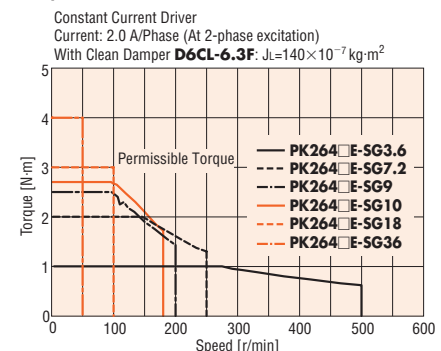

Note

● Depending on the driving conditions, a considerable amount of heat may be generated by the motor. Be sure to keep the motor case temperature at 100°C or less.

Dimensions

→ Page A-326

SH Geared Type Frame Size 90 mm (8 lead wires)

Specifications RoHS

Motor Specifications

Product Name	Connection Type	Rotor Inertia	Rated Current	Voltage	Resistance per Phase	Inductance	Wirings and Connections
Single Shaft Double Shaft		J: kg·m ²	A/Phase	VDC	Ω/Phase	mH/Phase	(See Page A-334)
PK296AE-SG PK296BE-SG 	Bipolar (Parallel)	1400×10 ⁻⁷	4.2	1	0.24	1.5	6
	Bipolar (Series)		2.1	2	0.96	6	5
	Unipolar		3	1.4	0.48	1.5	4

● A number indicating the gear ratio is entered where the box is located within the product name.

● Backlash value is approximately 1 to 2'.

Note

● The rotation direction of the motor and that of the gear output shaft are the same for the gear ratios 3.6, 7.2, 9, 10 and 18. It is the opposite for 36 gear ratio.

Gearmotor Specifications

Product Name	Maximum Holding Torque	Basic Step Angle	Gear Ratio	Permissible Torque	Permissible Speed Range
Single Shaft Double Shaft	N·m			N·m	r/min
PK296AE-SG3.6 PK296BE-SG3.6	2.5	0.5°	3.6	2.5	0~500
PK296AE-SG7.2 PK296BE-SG7.2	5	0.25°	7.2	5	0~250
PK296AE-SG9 PK296BE-SG9	6.3	0.2°	9	6.3	0~200
PK296AE-SG10 PK296BE-SG10	7	0.18°	10	7	0~180
PK296AE-SG18 PK296BE-SG18	9	0.1°	18	9	0~100
PK296AE-SG36 PK296BE-SG36	12	0.05°	36	12	0~50

● Maximum holding torque is the same regardless of the connection type due to the permissible torque limit of the gearhead.

Speed – Torque Characteristics

PK296AE-SG /PK296BE-SG

Bipolar (Series) 24 VDC

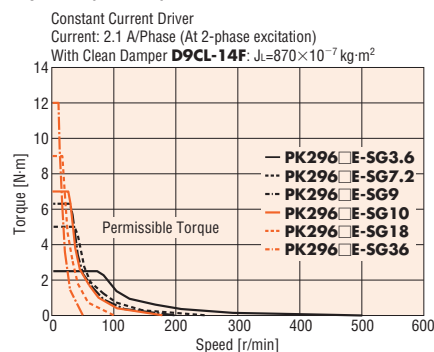

PK296AE-SG /PK296BE-SG

Bipolar (Series) 48 VDC

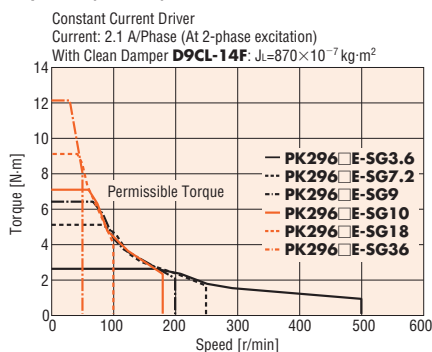

PK296AE-SG /PK296BE-SG

Unipolar 24 VDC

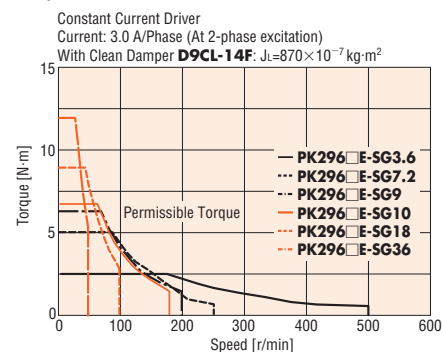

Note

● Depending on the driving conditions, a considerable amount of heat may be generated by the motor. Be sure to keep the motor case temperature at 100°C or less.

Dimensions

→ Page A-326

Dimensions (Unit = mm)

Frame Size 42 mm

Product Name	Gear Ratio	Mass kg
PK243A1-SG <input type="checkbox"/>	3.6, 7.2, 9, 10, 18, 36, 50, 100	0.35
PK243B1-SG <input type="checkbox"/>		

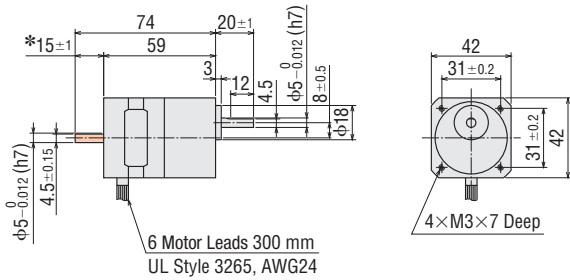

*The length of the shaft flat on the double shaft model is 15±0.25.
●Included
Mounting Screws: M3 Length 10 mm×4

Frame Size 60 mm

Product Name	Gear Ratio	Mass kg
PK264AE-SG <input type="checkbox"/>	3.6, 7.2, 9, 10, 18, 36	0.75
PK264BE-SG <input type="checkbox"/>		
PK264A2-SG <input type="checkbox"/>	3.6, 7.2, 9, 10, 18, 36, 50, 100	0.75
PK264B2-SG <input type="checkbox"/>		

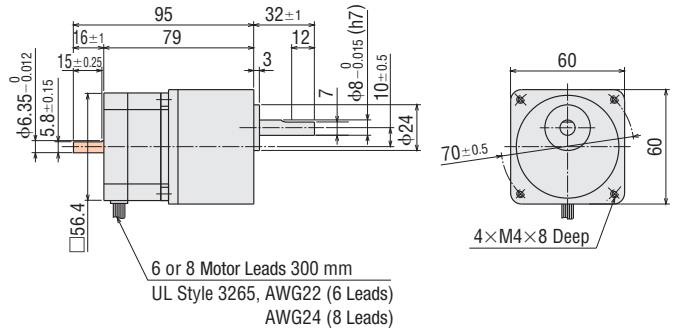

●Included
Mounting Screws: M4 Length 15 mm×4

Frame Size 90 mm

Product Name	Gear Ratio	Mass kg
PK296AE-SG <input type="checkbox"/>	3.6, 7.2, 9, 10, 18, 36	2.8
PK296BE-SG <input type="checkbox"/>		

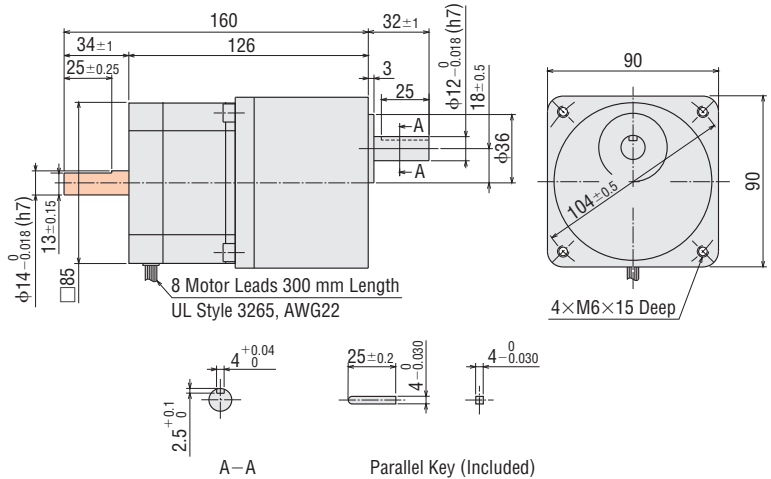

●Included
Mounting Screws: M6 Length 18 mm×4

●A number indicating the gear ratio is entered where the box is located within the product name.
●These dimensions are for double shaft models. For single shaft models, ignore the shaft in the shaded areas.

TH Geared Type Frame Size 42 mm (4 lead wires)

Specifications RoHS

Motor Specifications

Product Name	Connection Type	Rotor Inertia	Rated Current	Voltage	Resistance per Phase	Inductance	Wirings and Connections
Single Shaft Double Shaft		J: kg·m ²	A/Phase	VDC	Ω/Phase	mH/Phase	(See Page A-334)
PK243DA-T PK243DB-T	Bipolar	35×10 ⁻⁷	1.5	2.4	1.6	1.75	①

● A number indicating the gear ratio is entered where the box is located within the product name.

Note

● The rotation direction of the motor and that of the gear output shaft are the same for the gear ratios 3.6, 7.2 and 10. It is the opposite for 20 and 30 gear ratios.

Gearmotor Specifications

Product Name	Maximum Holding Torque	Basic Step Angle	Gear Ratio	Permissible Torque	Backlash	Permissible Speed Range
Single Shaft Double Shaft	N·m			N·m	arc minute (degrees)	r/min
PK243DA-T3.6 PK243DB-T3.6	0.35	0.5°	3.6	0.35	45 (0.75°)	0~500
PK243DA-T7.2 PK243DB-T7.2	0.7	0.25°	7.2	0.7	25 (0.42°)	0~250
PK243DA-T10 PK243DB-T10	1	0.18°	10	1		0~180
PK243DA-T20 PK243DB-T20	1.5	0.09°	20	1.5	15 (0.25°)	0~90
PK243DA-T30 PK243DB-T30		0.06°	30			0~60

Speed – Torque Characteristics

PK243DA-T□/PK243DB-T□

24 VDC

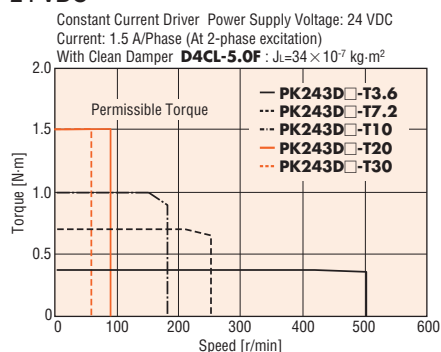

Note

● Depending on the driving conditions, a considerable amount of heat may be generated by the motor. Be sure to keep the motor case temperature at 100°C or less.

Dimensions (Unit = mm)

Product Name	Mass kg
PK243DA-T	0.35
PK243DB-T	

● A number indicating the gear ratio is entered where the box □ is located within the product name.

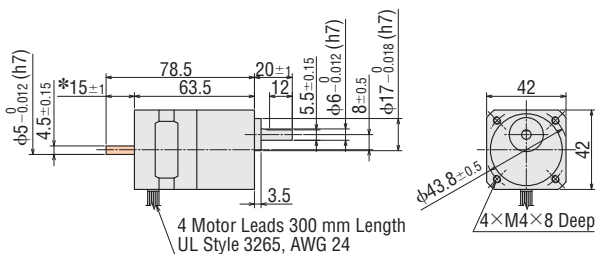

*The length of machining on double shaft model is 15±0.25.

● These dimensions are for double shaft models. For single shaft models, ignore the orange (■) areas.

TH Geared Type Frame Size 42 mm (6 lead wires)

Specifications RoHS

Motor Specifications

Product Name	Connection Type	Rotor Inertia	Rated Current	Voltage	Resistance per Phase	Inductance	Wirings and Connections	Corresponding Motor/Driver Packages	Package Product Speed-Torque Characteristics
Single Shaft Double Shaft		J: kg·m ²	A/Phase	VDC	Ω/Phase	mH/Phase	(See Page A-334)		Page
PK243A1-T PK243B1-T	Bipolar (Series) Unipolar	35×10 ⁻⁷	0.67	5.6	8.4	10	③	—	—
			0.95	4	4.2	2.5	②	CMK243 P-T	A-233

● A number indicating the gear ratio is entered where the box □ is located within the product name.

Either **A** or **B** indicating the motor shaft type is entered where the box □ is located within the product name.

● For the speed – torque characteristics of the motors in the table above, see the characteristics of the corresponding motor and driver package. If there is no corresponding package name, refer to the following characteristics.

Note

● The rotation direction of the motor and that of the gear output shaft are the same for the gear ratios 3.6, 7.2 and 10. It is the opposite for 20 and 30 gear ratios.

Gearmotor Specifications

Product Name	Maximum Holding Torque	Basic Step Angle	Gear Ratio	Permissible Torque	Backlash	Permissible Speed Range
Single Shaft Double Shaft	N·m			N·m	arc minute (degrees)	r/min
PK243A1-T3.6 PK243B1-T3.6	0.35	0.5°	3.6	0.35	45 (0.75°)	0~500
PK243A1-T7.2 PK243B1-T7.2	0.7	0.25°	7.2	0.7	25 (0.42°)	0~250
PK243A1-T10 PK243B1-T10	1	0.18°	10	1		0~180
PK243A1-T20 PK243B1-T20	1.5	0.09°	20	1.5	15 (0.25°)	0~90
PK243A1-T30 PK243B1-T30		0.06°	30			0~60

● Maximum holding torque is the same regardless of the connection type due to the permissible torque limit of the gearhead.

Speed – Torque Characteristics

PK243A1-T□/PK243B1-T□

Bipolar (Series) 24 VDC

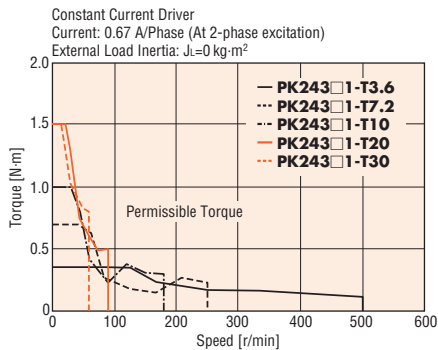

PK243A1-T□/PK243B1-T□

Bipolar (Series) 36 VDC

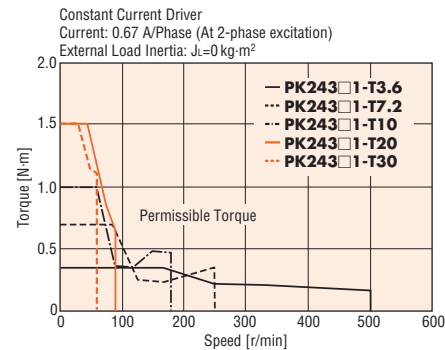

Note

● Depending on the driving conditions, a considerable amount of heat may be generated by the motor. Be sure to keep the motor case temperature at 100°C or less.

Dimensions (Unit = mm)

Product Name	Mass kg
PK243A1-T PK243B1-T	0.35

● A number indicating the gear ratio is entered where the box □ is located within the product name.

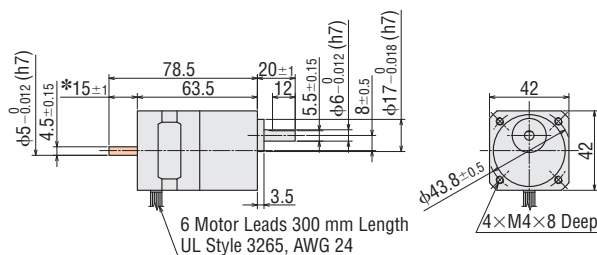

*The length of machining on double shaft model is 15±0.25.

● These dimensions are for double shaft models. For single shaft models, ignore the orange (■) areas.

TH Geared Type Frame Size 60 mm (4 lead wires)

Specifications RoHS

Motor Specifications

Product Name	Connection Type	Rotor Inertia	Rated Current	Voltage	Resistance per Phase	Inductance	Wirings and Connections
Single Shaft Double Shaft		J: kg·m ²	A/Phase	VDC	Ω/Phase	mH/Phase	(See Page A-334)
PK264DA-T PK264DB-T	Bipolar	120×10 ⁻⁷	4.2	1.26	0.3	0.6	①

● A number indicating the gear ratio is entered where the box is located within the product name.

Note

● The rotation direction of the motor and that of the gear output shaft are the same for the gear ratios 3.6, 7.2 and 10. It is the opposite for 20 and 30 gear ratios.

Gearmotor Specifications

Product Name	Maximum Holding Torque	Basic Step Angle	Gear Ratio	Permissible Torque	Backlash	Permissible Speed Range
Single Shaft Double Shaft	N·m			N·m	arc minute (degrees)	r/min
PK264DA-T3.6 PK264DB-T3.6	1.25	0.5°	3.6	1.25	35 (0.59°)	0~500
PK264DA-T7.2 PK264DB-T7.2	2.5	0.25°	7.2	2.5	15 (0.25°)	0~250
PK264DA-T10 PK264DB-T10	3	0.18°	10	3		0~180
PK264DA-T20 PK264DB-T20	3.5	0.09°	20	3.5	10 (0.17°)	0~90
PK264DA-T30 PK264DB-T30	4	0.06°	30	4		0~60

Speed – Torque Characteristics

PK264DA-T□/PK264DB-T□

24 VDC

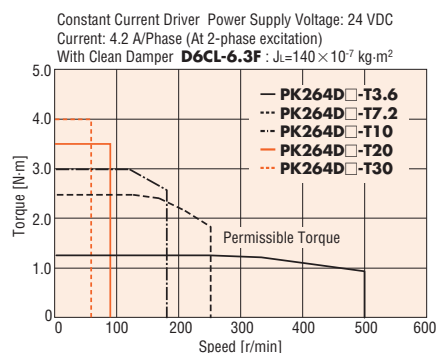

Note

● Depending on the driving conditions, a considerable amount of heat may be generated by the motor. Be sure to keep the motor case temperature at 100°C or less.

Dimensions (Unit = mm)

Product Name	Mass kg
PK264DA-T PK264DB-T	0.85

● A number indicating the gear ratio is entered where the box is located within the product name.

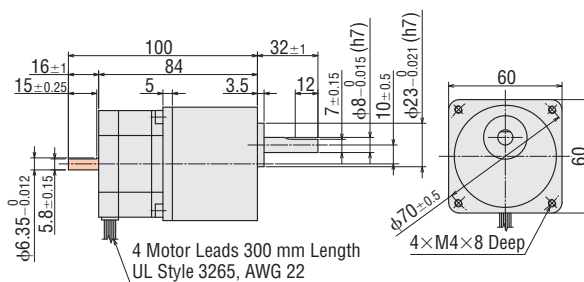

● These dimensions are for double shaft models. For single shaft models, ignore the orange (■) areas.

TH Geared Type Frame Size 60 mm (6 lead wires)

Specifications RoHS

Motor Specifications

Product Name	Connection Type	Rotor Inertia	Rated Current	Voltage	Resistance per Phase	Inductance	Wirings and Connections	Corresponding Motor/Driver Packages	Package Product Speed-Torque Characteristics
Single Shaft Double Shaft		J: kg·m ²	A/Phase	VDC	Ω/Phase	mH/Phase	(See Page A-334)		Page
PK264A2-T PK264B2-T	Bipolar (Series)	120×10 ⁻⁷	1.4	3.9	2.8	5.6	③	—	—
	Unipolar		2	2.8	1.4	1.4	②	CMK264 P-T	A-234

● A number indicating the gear ratio is entered where the box is located within the product name.

Either **A** or **B** indicating the motor shaft type is entered where the box is located within the product name.

● For the speed – torque characteristics of the motors in the table above, see the characteristics of the corresponding motor and driver package. If there is no corresponding package name, refer to the following characteristics.

Note

● The rotation direction of the motor and that of the gear output shaft are the same for the gear ratios 3.6, 7.2 and 10. It is the opposite for 20 and 30 gear ratios.

Gearmotor Specifications

Product Name	Maximum Holding Torque	Basic Step Angle	Gear Ratio	Permissible Torque	Backlash	Permissible Speed Range
Single Shaft Double Shaft	N·m			N·m	arc minute (degrees)	r/min
PK264A2-T3.6 PK264B2-T3.6	1.25	0.5°	3.6	1.25	35 (0.59°)	0~500
PK264A2-T7.2 PK264B2-T7.2	2.5	0.25°	7.2	2.5	15 (0.25°)	0~250
PK264A2-T10 PK264B2-T10	3	0.18°	10	3		0~180
PK264A2-T20 PK264B2-T20	3.5	0.09°	20	3.5	10 (0.17°)	0~90
PK264A2-T30 PK264B2-T30	4	0.06°	30	4		0~60

● Maximum holding torque is the same regardless of the connection type due to the permissible torque limit of the gearhead.

Speed – Torque Characteristics

PK264A2-T/PK264B2-T

Bipolar (Series) 24 VDC

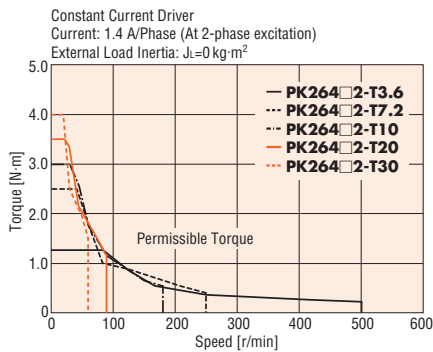

PK264A2-T/PK264B2-T

Bipolar (Series) 48 VDC

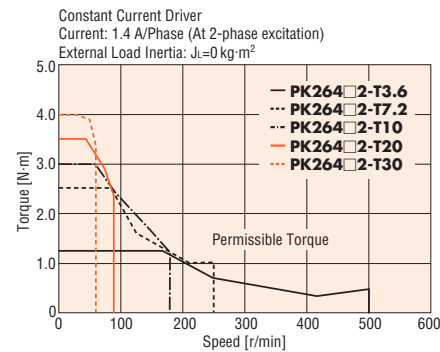

Note

● Depending on the driving conditions, a considerable amount of heat may be generated by the motor. Be sure to keep the motor case temperature at 100°C or less.

Dimensions (Unit = mm)

Product Name	Mass kg
PK264A2-T PK264B2-T	0.85

● A number indicating the gear ratio is entered where the box is located within the product name.

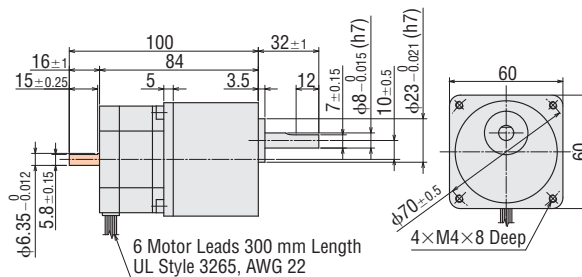

● These dimensions are for double shaft models. For single shaft models, ignore the orange areas.

PS Geared Type Frame Size 28 mm (4 lead wires)

Specifications RoHS

Motor Specifications

Product Name Single Shaft Double Shaft	Connection Type	Rotor Inertia J: kg·m ²	Rated Current A/Phase	Voltage VDC	Resistance per Phase Ω/Phase	Inductance mH/Phase	Wirings and Connections (See Page A-334)	Corresponding Motor/Driver Packages	Package Product Speed-Torque Characteristics Page
PK223PDA-PS □-L PK223PDB-PS □-L	Bipolar	9×10 ⁻⁷	1.5	1.8	1.2	0.74	①	RBK223P □-PS□	A-204

- A number indicating the gear ratio is entered where the box □ is located within the product name.
Either **A** or **B** indicating the motor shaft type is entered where the box □ is located within the product name.
- For the speed – torque characteristics of the motors in the table above, see the characteristics of the corresponding motor and driver package.

Note

- The rotation direction of the motor and that of the gear output shaft are the same.

Gearmotor Specifications

Product Name Single Shaft Double Shaft	Maximum Holding Torque N·m	Basic Step Angle	Gear Ratio	Permissible Torque N·m	Maximum Torque N·m	Backlash arc minute (degrees)	Permissible Speed Range r/min
PK223PDA-PS5-L PK223PDB-PS5-L	0.3	0.36°	5	0.3	0.5	35 (0.59°)	0~600
PK223PDA-PS10-L PK223PDB-PS10-L	0.5	0.18°	10	0.5			0~300

Dimensions (Unit = mm)

Product Name	Motor Product Name	Gear Ratio	Mass kg
PK223PDA-PS □-L PK223PDB-PS □-L	PK223PDA-PS□ PK223PDB-PS□	5, 10	0.11

- A number indicating the gear ratio is entered where the box □ is located within the product name.

Applicable Connector

Connector Housing: 51065-0600 (Molex)
Contact: 50212-8100 (Molex)
Crimp Tool: 57176-5000 (Molex)

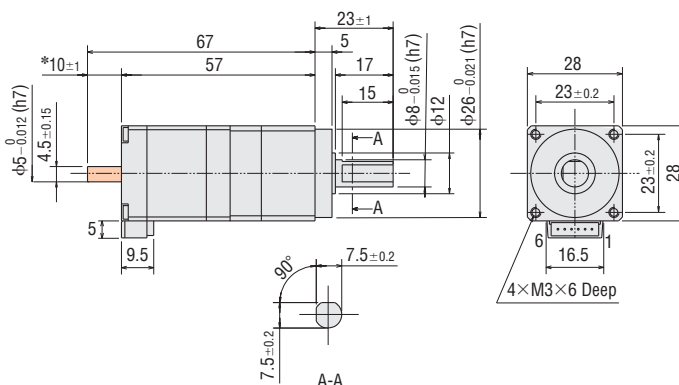

*The length of the shaft flat on the double shaft model is 10±0.25.

- These dimensions are for double shaft models. For single shaft models, ignore the shaft in the shaded areas.

- Included

Connection Cable: **LC2B06A**

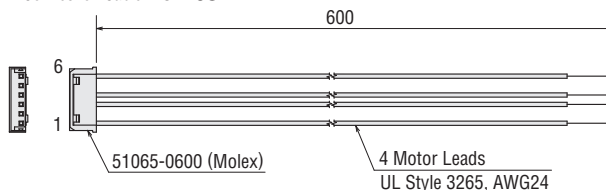

Accessories (Sold separately)

Connection cable and motor connector set are available as accessories.

- Connection cable → Page A-358
- Motor connector set → Page A-358

PL Geared Type Frame Size 42 mm (4 lead wires)

Specifications RoHS

Motor Specifications

Product Name	Connection Type	Rotor Inertia	Rated Current	Voltage	Resistance per Phase	Inductance	Wirings and Connections	Corresponding Motor/Driver Packages	Package Product Speed-Torque Characteristics Page
Single Shaft Double Shaft		J: kg·m ²	A/Phase	VDC	Ω/Phase	mH/Phase	(See Page A-334)		
PK244PDA-P□-L PK244PDB-P□-L PK244PDA-P36-L PK244PDB-P36-L	Bipolar	57×10 ⁻⁷	1.5	2.14 1.2	1.43 0.8	1.5 0.47	①	RBK244P□-P□ RBK244P□-P36	A-205

- A number indicating the gear ratio is entered where the box □ is located within the product name.
- Either **A** or **B** indicating the motor shaft type is entered where the box □ is located within the product name.
- For the speed – torque characteristics of the motors in the table above, see the characteristics of the corresponding motor and driver package.

Note

- The rotation direction of the motor and that of the gear output shaft are the same.

Gearmotor Specifications

Product Name	Maximum Holding Torque	Basic Step Angle	Gear Ratio	Permissible Torque	Backlash	Permissible Speed Range
Single Shaft Double Shaft	N·m			N·m	arc minute (degrees)	r/min
PK244PDA-P5-L PK244PDB-P5-L	1	0.36°	5	1	35 (0.59°)	0~360
PK244PDA-P10-L PK244PDB-P10-L	1.5	0.18°	10	1.5		0~180
PK244PDA-P36-L PK244PDB-P36-L	3	0.05°	36	3		0~50

Dimensions (Unit = mm)

Product Name	Motor Product Name	Gear Ratio	L1	L2	Mass kg
PK244PDA-P□-L PK244PDB-P□-L	PK244PDA-P□ PK244PDB-P□	5, 10	66.5	81.5	0.48
PK244PDA-P36-L PK244PDB-P36-L	PK244PDA-P36 PK244PDB-P36	36	90	105	0.6

- A number indicating the gear ratio is entered where the box □ is located within the product name.

Applicable Connector

Connector Housing: 51103-0600 (Molex)
Contact: 50351-8100 (Molex)
Crimp Tool: 57295-5000 (Molex)

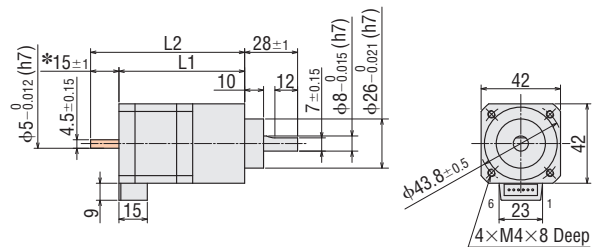

*The length of the shaft flat on the double shaft model is 15±0.25.

- These dimensions are for double shaft models. For single shaft models, ignore the shaft in the shaded areas.

Included

Connection Cable: **LC2B06B**

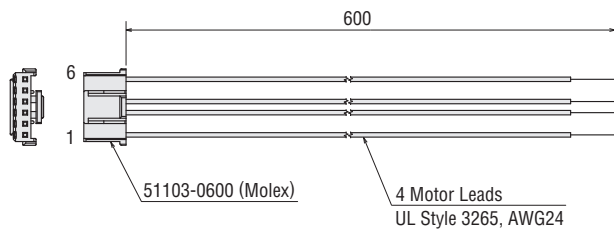

Accessories (Sold separately)

Connection cable and motor connector set are available as accessories.

- Connection cable → Page A-358
- Motor connector set → Page A-358

PL Geared Type Frame Size 60 mm (4 lead wires)

Specifications RoHS

Motor Specifications

Product Name Single Shaft Double Shaft	Connection Type	Rotor Inertia J: kg·m ²	Rated Current A/Phase	Voltage VDC	Resistance per Phase Ω/Phase	Inductance mH/Phase	Wirings and Connections (See Page A-334)	Corresponding Motor/Driver Packages	Package Product Speed-Torque Characteristics Page
PK266PDA-P□-L PK266PDB-P□-L	Bipolar	290×10 ⁻⁷	2.8	1.62	0.58	0.97	①	RBK266P□-P□	A-206
PK264PDA-P36-L PK264PDB-P36-L		120×10 ⁻⁷		1.29	0.46	0.73		RBK264P□-P36	

- A number indicating the gear ratio is entered where the box □ is located within the product name.
Either **A** or **B** indicating the motor shaft type is entered where the box □ is located within the product name.
- For the speed – torque characteristics of the motors in the table above, see the characteristics of the corresponding motor and driver package.

Note

- The rotation direction of the motor and that of the gear output shaft are the same.

Gearmotor Specifications

Product Name Single Shaft Double Shaft	Maximum Holding Torque N·m	Basic Step Angle	Gear Ratio	Permissible Torque N·m	Backlash arc minute (degrees)	Permissible Speed Range r/min
PK266PDA-P5-L PK266PDB-P5-L	3.5	0.36°	5	3.5	20 (0.33°)	0~360
PK266PDA-P10-L PK266PDB-P10-L	5	0.18°	10	5		0~180
PK264PDA-P36-L PK264PDB-P36-L	8	0.05°	36	8		0~50

Dimensions (Unit = mm)

Product Name	Motor Product Name	Gear Ratio	L1	L2	Mass kg
PK266PDA-P□-L	PK266PDA-P□	5, 10	89	112	1.23
PK266PDB-P□-L	PK266PDB-P□				
PK264PDA-P36-L	PK264PDA-P36	36	99	122	1.26
PK264PDB-P36-L	PK264PDB-P36				

- A number indicating the gear ratio is entered where the box □ is located within the product name.

Applicable Connector

Connector Housing: 51067-0600 (Molex)
Contact: 50217-9101 (Molex)
Crimp Tool: 57189-5000 (Molex)
57190-5000 (Molex)

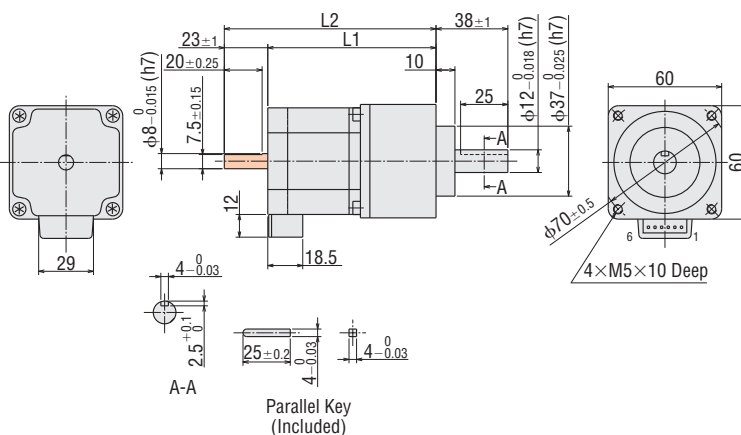

- These dimensions are for double shaft models. For single shaft models, ignore the shaft in the shaded areas.

- Included Connection Cable: **LC2B06C**

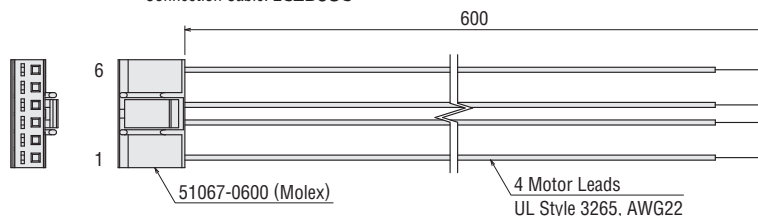

Accessories (Sold separately)

Connection cable and motor connector set are available as accessories.

- Connection cable → Page A-358
- Motor connector set → Page A-358

28 mm

42 mm

50 mm

56.4 mm

60 mm

85 mm

90 mm

General Specifications

Specifications		Motor
Thermal Class		130 (B) [Standard Type with Cable and Terminal Box: These Motors are recognized as 105 (A) under UL and CSA Standards.]
Insulation Resistance		The measured value is 100 MΩ min. when a 500 VDC megger is applied between the windings and the case under normal ambient temperature and humidity.
Dielectric Strength		No abnormality is judged even with application of 1.0 kVAC at 50 Hz or 60 Hz between the windings and the case for 1 minute under normal ambient temperature and humidity. (0.5 kV: For models with a frame size of 42 mm or smaller. 1.5 kV: For models with a standard type with cable and terminal box and PK29□D)
Operating Environment (In operation)	Ambient Temperature	-10~+50°C (non-freezing)
	Ambient Humidity	85% max. (non-condensing)
	Atmosphere	Use in an area without corrosive gases or dust. The product should not be directly exposed to water, oil or other liquids. (Standard Type with Terminal Box: No corrosive gases and no direct exposure to oil)
Temperature Rise		<ul style="list-style-type: none"> Unipolar Temperature rise of windings is 80°C max. measured by the resistance change method (at rated voltage, at standstill, 2-phase excitation). Bipolar Temperature rise of windings is 80°C max. measured by the resistance change method (at rated current, at standstill, 2-phase excitation). The following motors are with aluminum heat radiation plates. PK22□PD, PK24□D : 115×115×5 mm PK24□PD : 175×175×5 mm PK26□PD, PK26□D : 250×250×10 mm * PK26□JD is the same as the unipolar specification.
Stop Position Accuracy*1		±3 arc minutes (±0.05°) [PK26□J, PK26□JD : ±2 arc minutes (±0.034°)]
Shaft Runout		0.05 T. I. R. (mm)*4
Radial Play*2		0.025 mm max. (Load 5 N)
Axial Play*3		0.075 mm max. (Load 10 N)
Concentricity		0.075 T. I. R. (mm)*4
Perpendicularity		0.075 T. I. R. (mm)*4

*1 This value is for full step under no load. (The value changes with the size of the load).

*2 Radial Play: Displacement in shaft position in the radial direction when 5 N load is applied in the vertical direction to the tip of the motor's shaft.

*3 Axial Play: Displacement in shaft position in the axial direction when a 10 N load is applied to the motor's shaft in the axial direction.

*4 T. I. R. (Total Indicator Reading): The total dial gauge reading when the measurement section is rotated one revolution centered on the reference axis center.

Note

Do not measure insulation resistance or perform the dielectric strength test while the motor and driver are connected.

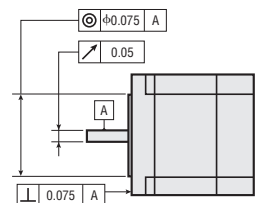

Wirings and Connections

High-Resolution Type, High-Torque, High-Efficiency Type, High-Torque Type, Standard Type and Geared Type

Motor Wirings

4 Leads Motor

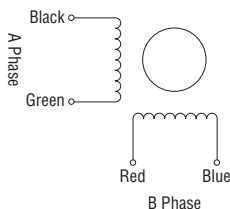

6 Leads Motor

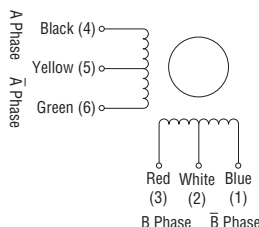

8 Leads Motor

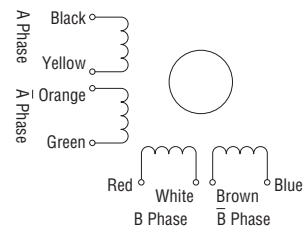

Wiring Connection Diagrams

1 4 Leads Bipolar Connection

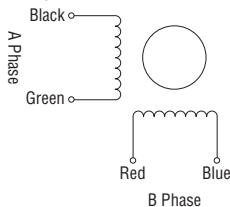

2 6 Leads Unipolar Connection

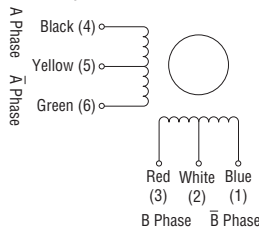

3 6 Leads Bipolar (Series) Connection

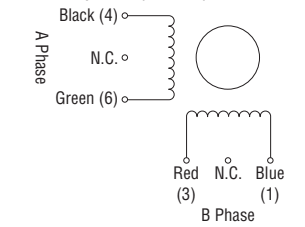

4 8 Leads Unipolar Connection

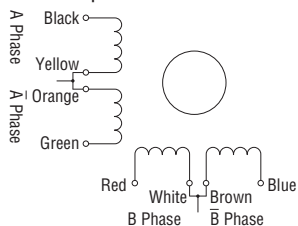

5 8 Leads Bipolar (Series) Connection

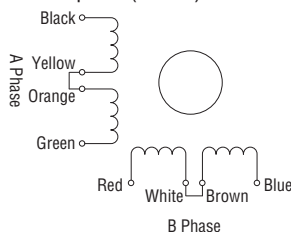

6 8 Leads Bipolar (Parallel) Connection

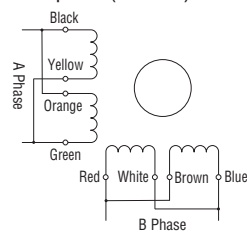

Note

The numbers inside the parentheses indicate the connector pin No. of the high-efficiency type and high-torque type.

N.C.: No Connection

● Standard Type with Terminal Box

◇ Motor Wirings

● PK26□DAT, PK26□D1T

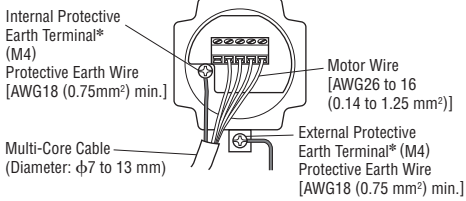

*Use either the internal or external protective earth terminal for grounding.

● PK29□DT, PK29□EAT

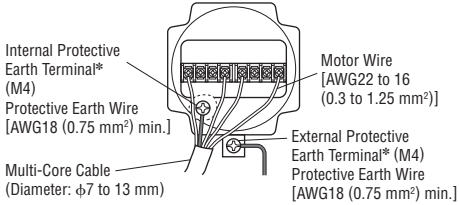

*Use either the internal or external protective earth terminal for grounding.

Connect motor lead wires to the terminals 2 to 5.

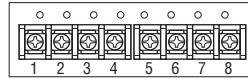
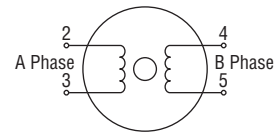
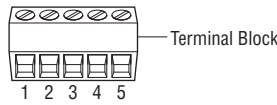

● PK29□DT

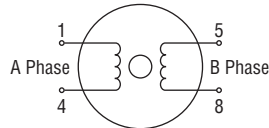

● PK29□EAT

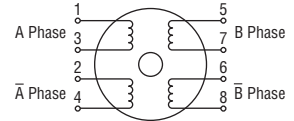

◇ Wirings Connection Diagrams

● PK26□DAT, PK26□D1T

7 Bipolar

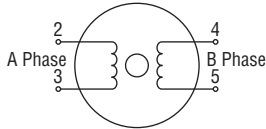

Connect motor lead wires to the terminals 2 to 5.

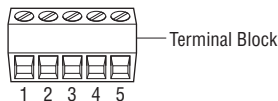

● PK29□DT

8 Bipolar

Connect motor lead wires to the terminal 1, 4, 5 and 8.

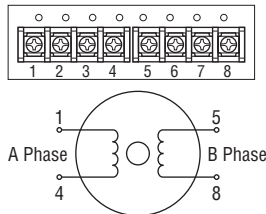

● PK29□EAT

9 Bipolar (Series)

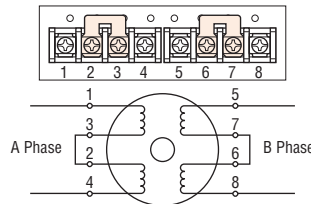

10 Bipolar (Parallel)

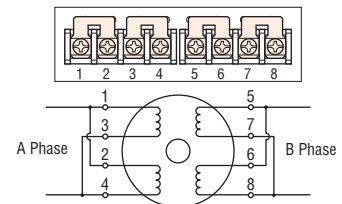

11 Unipolar

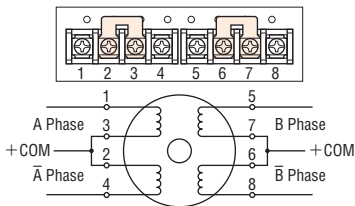

Introduction
AC Input Motor & Driver
0.36°/Geared AR 0.72°/Geared RK
DC Input Motor & Driver
0.36°/Geared AR 0.36°/0.72°/ Geared CRK 1.8°/Geared RBK 0.9°/1.8°/Geared CMK
Motor Only
0.72° PK 1.8°/Geared High-Torque PKL 0.9°/1.8°/Geared PK
Controllers SG80301Y
Accessories

28 mm

42 mm

50 mm

56.4 mm

60 mm

85 mm

90 mm

Encoder Specifications

Encoder Code		R21	R22
Type	Incremental		
Resolution	200 P/R	400 P/R	
Output	3-Channel A, B, Index		
Input Current	57 mA (Typ.)		
Input Voltage	5 VDC ±10%		
Output Type	TTL		
Output Voltage	Low	0.4 VDC	
	High	2.4 VDC	
Response Frequency	100 kHz (Max.)		

Encoder Pin-Outs

Pin No.	Lead Wire Color of Encoder Cable	Encoder Code	
		R21	R22
1	Black	GND	
2	Blue	Index Channel	
3	White	A Channel	
4	Red	+5 VDC Power	
5	Brown	B Channel	