

Electric Cylinders

EAC Series α STEP AZ/AR Equipped

<Additional Information>
 ● Technical reference → Page H-1
 ● Regulations & Standards → Page I-2

α STEP
AZ
Equipped

α STEP
AR
Equipped

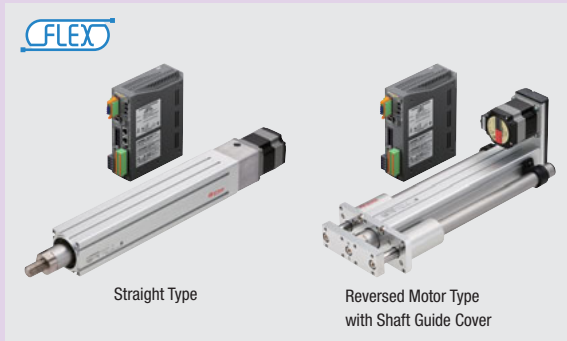

The motor component incorporates a high-efficiency, energy-saving α STEP AZ/AR Series electric cylinder. In addition to straight-type actuators, reversed motor types with shorter overall lengths are also available.

- Compact, High Strength, for a Wide Variety of Applications
- High Performance Regardless of Operating Conditions
- Easy Belt Replacement (Reversed Motor Type)

FLEX What is FLEX?

FLEX is the collective name for products that support I/O control, Modbus (RTU) control, and FA network control via network converters. These products enable simple connection and simple control, shortening the total lead time for system construction.

Features

Compact and Powerful!

● Compact, High Thrust Force Cylinders

Using aluminum for the rod, these electric cylinders produce high thrust force despite their compact and lightweight body. The unique structure suppresses vibration to achieve improved acceleration characteristics and high-speed positioning operation. This illustration shows a straight type without shaft guide.

Motor

A standard motor is equipped.

α STEP AZ Series

- Battery-free, Absolute Sensor Equipped
- Positioning Information is Available without a sensor
- High Reliability with Closed Loop Control
- High Efficiency Technology Reduces Motor Heat Generation and Saves Energy



Built-in Controller Type



Pulse Input Type

α STEP AR Series

- High Reliability with Closed Loop Control
- High Efficiency Technology Reduces Motor Heat Generation and Saves Energy



Built-in Controller Type



Pulse Input Type

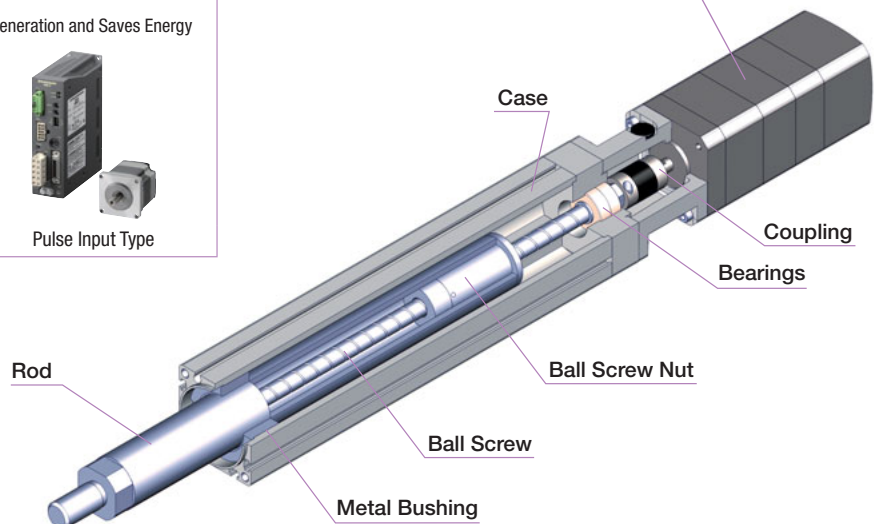

● Cylinder Type and Configuration

The **EAC** Series has reversed motor types and straight types. For both types, the following three types of cylinders are available: without shaft guide, with shaft guide, and with shaft guide cover.

◇ Reversed Motor Type

Thanks to the belt mechanism, this type features a reversed motor installation direction.

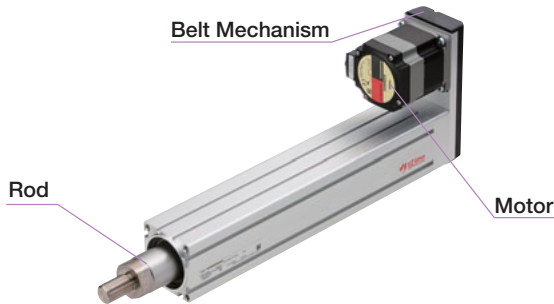

Reversed Motor types are provided for all electric cylinders. This contributes to a shorter overall length and space savings.

αSTEP AZ Series Equipped
EAC4 with Electromagnetic Brake Type Stroke 200 mm

Straight Type

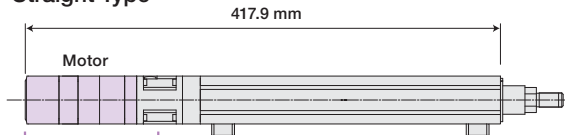

Reversed Motor Type

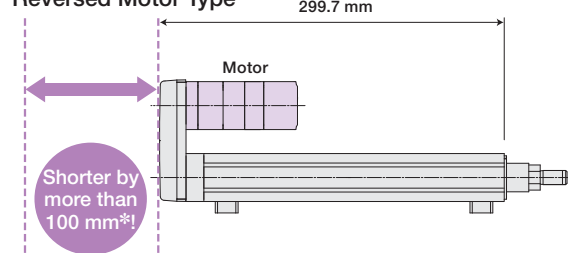

*When electromagnetic brake is installed

Thanks to Oriental Motor's unique belt tension adjustment mechanism, belt replacement is easy.

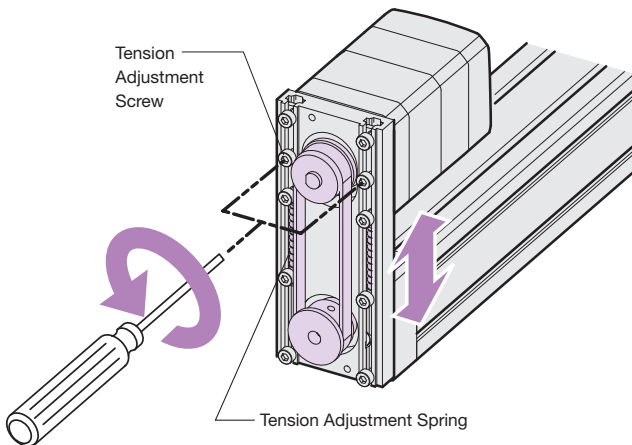

If the screw is loosened, the belt tension is adjusted to an appropriate value by the force of the spring.

◇ With Shaft Guide/With Shaft Guide Cover

This type has a shaft guide and cover installed, which allows for the load to be transported while attached directly to the body of this product.

Straight types and reversed motor types are available.

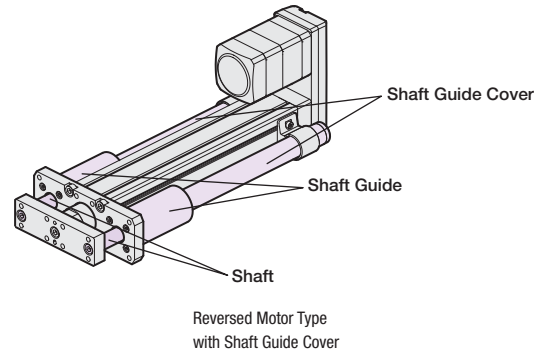
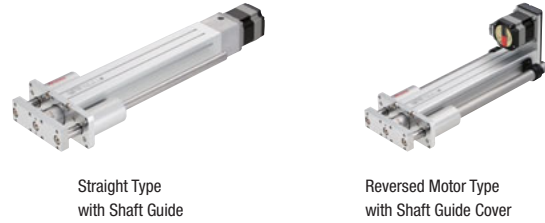

● Cable Outlet Direction

Rotatable in 4 directions (3 directions for Reversed Motor types)

Motor cable can be changed to any direction by simply rotating the motor. There is no need to leave space behind the motor since the cable outlet is on one side of the motor, allowing for easy connection and saving space.

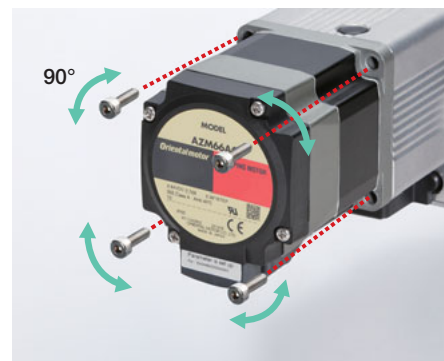

Overview, Product Series

Electric Linear Slides

αSTEP AZ/AR EAS

αSTEP AZ/AR EZS

Electric Cylinders

αSTEP AZ/AR EAC

Compact Linear Actuators

αSTEP AZ DRS2

DRLII

Installation

Hollow Rotary Actuators

αSTEP AZ/AR DGII

Accessories

High Performance Provided with α STEP

High performance is achieved by equipping the α STEP AZ Series and AR Series.

α STEP
AZ
Equipped

α STEP
AR
Equipped

● High Response

By utilizing the high responsiveness of the stepper motor, moving a short distance for a short time is possible. The motors can execute commands without lagging.

● Actual Movement of Stepper Motor under Operation Commands

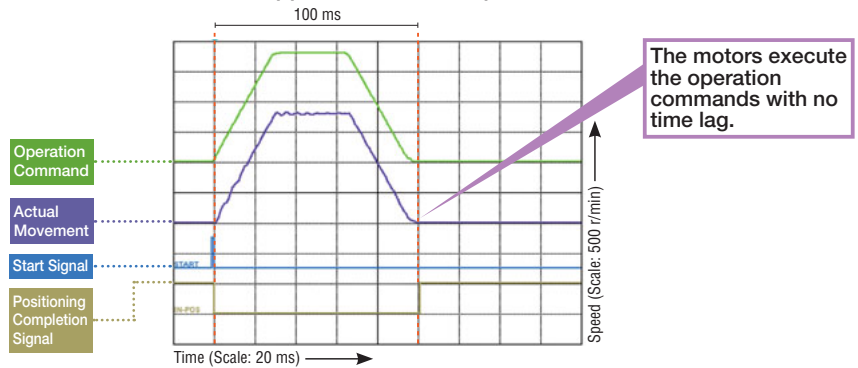

● Smooth Operation Even at Low Speed

Thanks to the standard microstep drive and smooth drive function*, vibration is reduced and the motor can move objects smoothly.

*The smooth drive function automatically microsteps based on the same traveling amount and traveling speed used in the full step mode, without changing the pulse input settings.

<Example Operation>

Load Mass: 0.5 kg
Running Current: 100%
Min. Traveling Amount: 0.01 mm/step
Operating Speed: 1.25 mm/s

<Product Used>

Product Name: **EAC4**
Lead screw pitch: 12 mm
Power Supply Input: 230 VAC

● Actual Speed of Electric Cylinder Rod Compared to Operation Commands (1.25 mm/s)

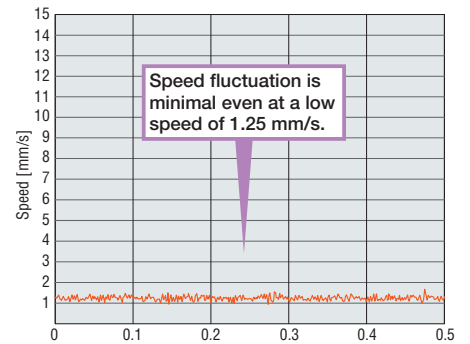

● Energy Savings, Low Heat Generation

High-efficiency motors reduce heat generation and save energy.

◇ Significantly Reduced Heat Generation

● Temperature Distribution by Thermography

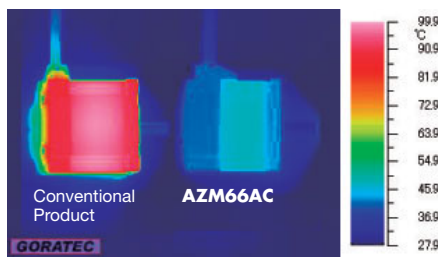

Comparison under the same conditions.

● Motor Surface Temperature during Operation Under the Same Conditions

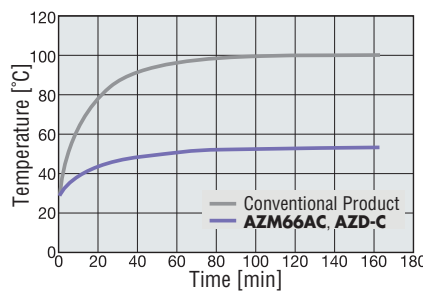

◇ Power Consumption 47% Less than Conventional Products

● Power Consumption

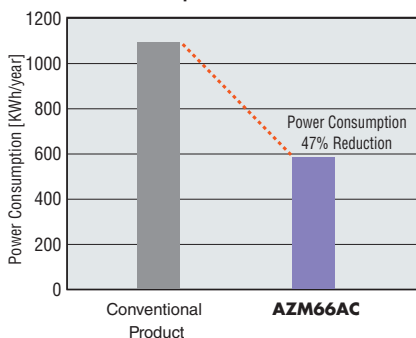

Operating Condition
Speed: 1000 r/min, 50% load factor
Operating Time: 24 hours of operation
(70% operating, 25% stand-by, 5% off), 365 days/year
Power Supply Input: 230 VAC

● **Wide Range of Applications, from Low Speed to High Speed and from Light Loads to Heavy Loads**

Only at Oriental Motor!

High speed driving is possible whether the load is light or heavy.
 The positioning time, operating speed and acceleration can all be easily determined.
 The product can be selected while estimating the movement from the same graph, even under changing operating conditions such as no load or inching.
 Let our technical team help find the right actuator based on your profile demands.

<Product Used>
 Product name: **EAC6WE**
 Lead Screw Pitch: 6 mm
 Power Supply Input: 230 VAC

When transferring a load of 14 kg over a distance of 300 mm, the positioning time is 1.12 seconds.

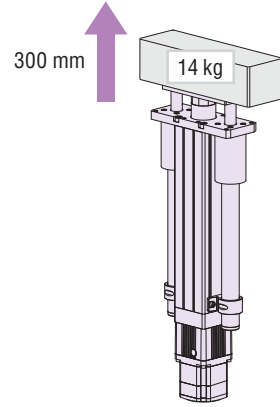

Overview, Product Series

Electric Linear Slides

Q^{STEP} AZ/AR EAS

Q^{STEP} AZ/AR EZS

Electric Cylinders

Q^{STEP} AZ/AR EAC

Compact Linear Actuators

Q^{STEP} AZ DRS2

DRLII

Installation

Hollow Rotary Actuators

Q^{STEP} AZ/AR DGII

Accessories

High-Speed With a Heavy Load

Load Mass: 14 kg
 Positioning Distance: 300 mm
Positioning Time: 1.12 s
 Operating Speed: 300 mm/s
 Acceleration: 2.48 m/s² (0.25 G)

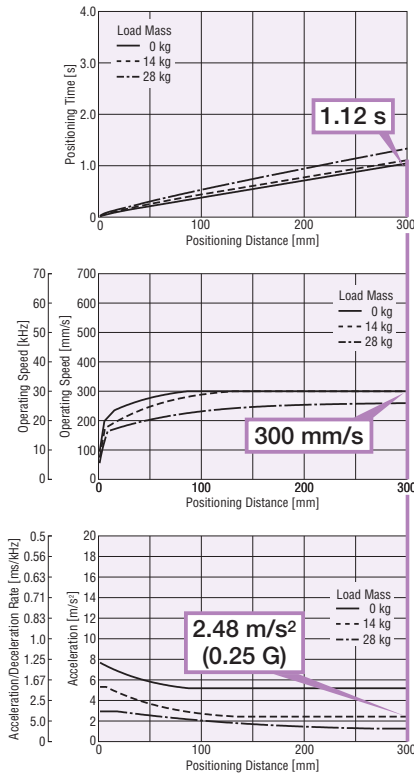

High-Speed With a Light Load

Load Mass: 0 kg
 Positioning Distance: 300 mm
Positioning Time: 1.06 s
 Operating Speed: 300 mm/s
 Acceleration: 5.25 m/s² (0.5 G)

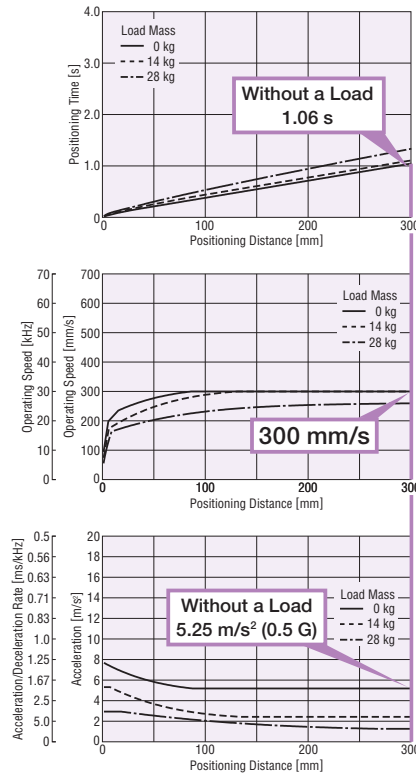

High-Speed During Inching Operation

Load Mass: 14 kg
 Positioning Distance: 20 mm
Positioning Time: 0.14 s
 Operating Speed: 200 mm/s
 Acceleration: 5.3 m/s² (0.5 G)

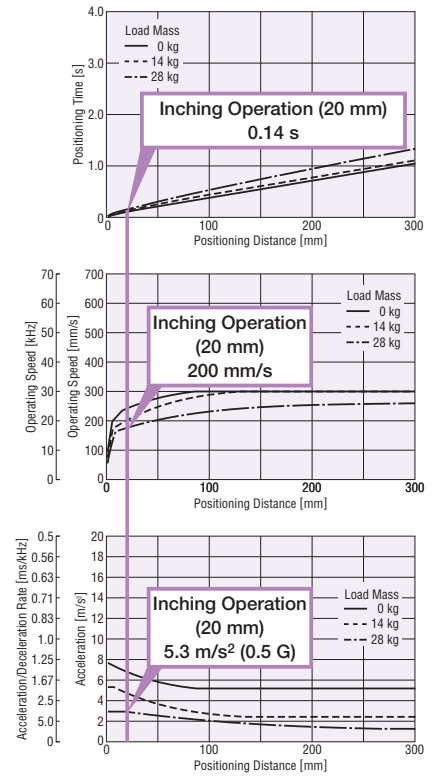

α STEP AZ Series Equipped

α STEP AZ Series equipped with the absolute sensor does not require a battery, home sensor, or external sensor to hold the positioning information.

α STEP
AZ
Equipped

α STEP
AR
Equipped

● No External Sensors Required

Thanks to the absolute sensor, a home sensor or external sensor is not required.

- Cost Reduction
- Simple Wiring
- Not Affected by Sensor Malfunctions
- Improved Return-to-Home Accuracy

Home position accuracy is increased because the return-to-home operation is not affected by any variations in home sensor sensitivity.

● High-Speed Return-to-Home

Normal Return-to-Home

The home position is detected at low speed by detecting the limit sensors and home sensor. Therefore, it takes time to perform Return-to-Home.

Return-to-Home Operation of AZ Series

There is no need to detect the limit sensors or home sensor, so the table can travel at high speed to the home position recorded by the absolute sensor.

● Return-to-Home is Not Necessary (Built-in Controller Type)

Even if the power turns off, the positioning information can be retained, which allows the motor to restart the operation without Return-to-Home after an emergency stop or power failure.

● No Battery Required

The positioning information can be held even if the power turns off, thanks to the mechanical-type sensor. There is no concern about regulations for overseas shipping, since a battery is not required.

● Parameters Set and Startup Time Reduced

For example, the settings on the right are not required.

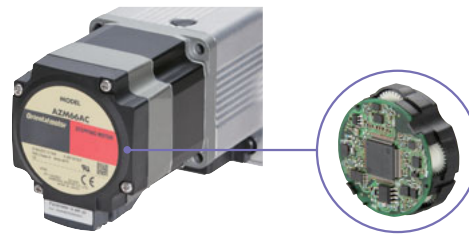

Battery-free Absolute Sensor Installed

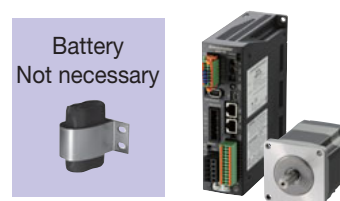
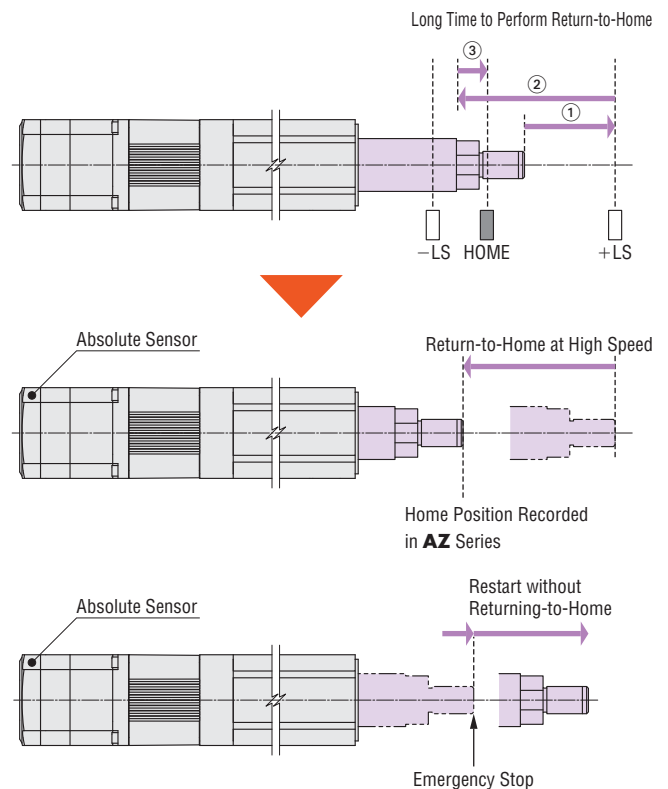

- Calculating and setting the electronic gear according to differences in the ball screw lead (the min. traveling amount is already set to 0.01 mm).
- Resetting the traveling direction coordinates by the motor installation direction (straight/reversed) (moves in the same direction by the same instruction, regardless of the motor installation direction).

2 Driver Types Available to Match the System Configuration

Built-in Controller Type **FLEX**

With this type, the operating data is set in the driver, and is then selected and executed from the host system. Host system connection and control are performed with any of the following: I/O, Modbus (RTU), RS-485, or FA network. By using a network converter (sold separately)/CC-link, MECHATROLINK or EtherCAT communication are possible.

FLEX

FLEX is the collective name for products that support I/O control, Modbus (RTU) control, and FA network control via network converters. These products enable simple connection and simple control, shortening the total lead time for system construction.

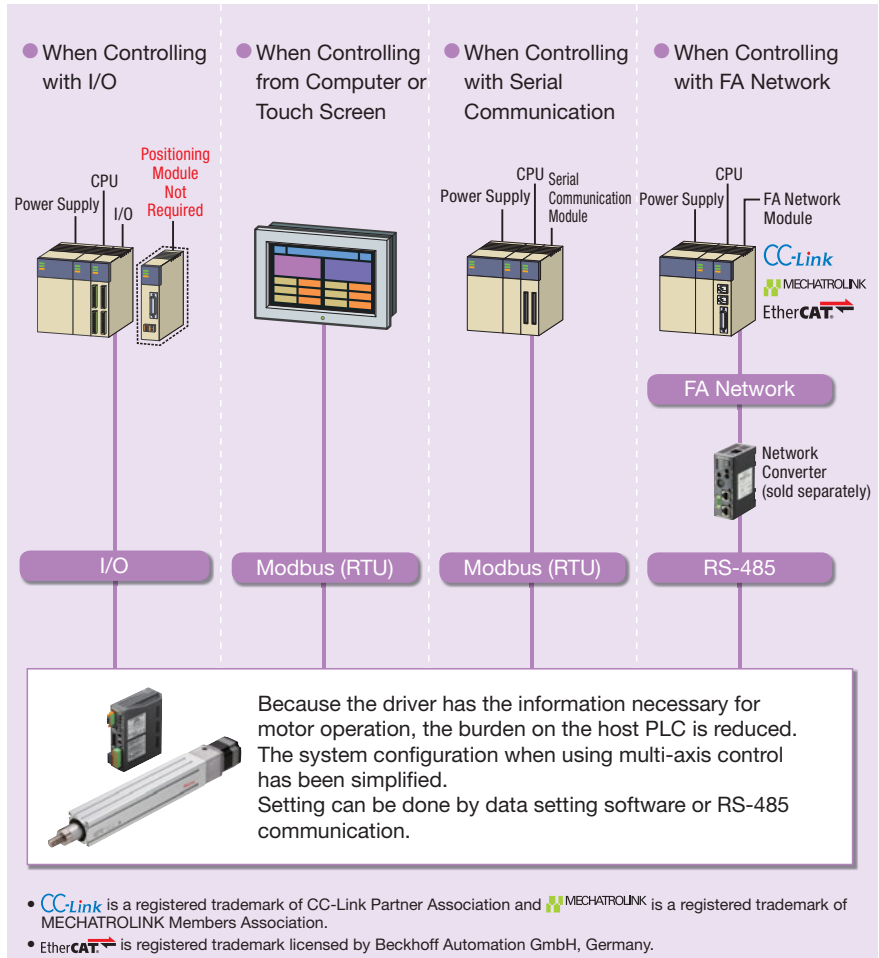

Pulse Input Type

This type executes operations by inputting pulses into the driver. It controls the motor using a positioning module (pulse generator).

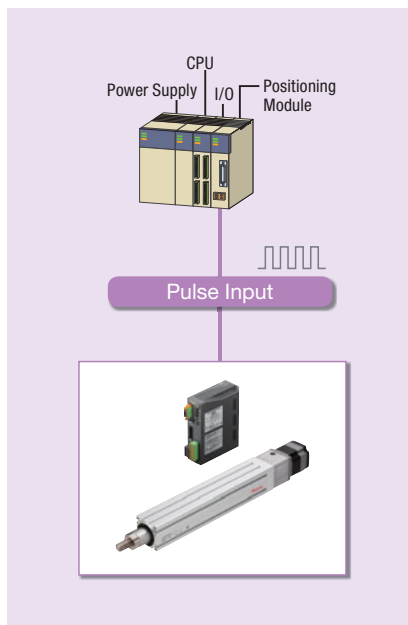

Overview, Product Series

Electric Linear Slides

QSTEP AZ/AR EAS

QSTEP AZ/AR EZS

Electric Cylinders

QSTEP AZ/AR EAC

Compact Linear Actuators

QSTEP AZ DRS2

DRLII

Installation

Hollow Rotary Actuators

QSTEP AZ/AR DGII

Accessories

Set and Operate Easily from a PC

By using the data setting software **MEXE02**, data setting, saving, actual operation, and confirmation via each monitor function can be performed easily on a computer.

α STEP
AZ
Equipped

Data Setting Software MEXE02

The data setting software **MEXE02** can be downloaded from the website.



α STEP
AR
Equipped

Operating Data/Parameter Settings

You can easily set and save the operating data and parameters on a computer. And then by forwarding the saved data when you replace the driver, etc. the settings will be the same.

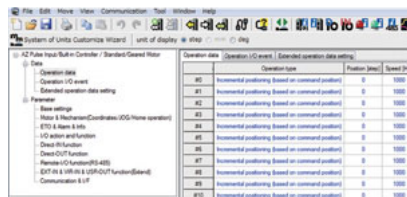

Teaching and Remote Operation

Data setting software can be used to drive the motor. This can be used for teaching or test drive purposes.

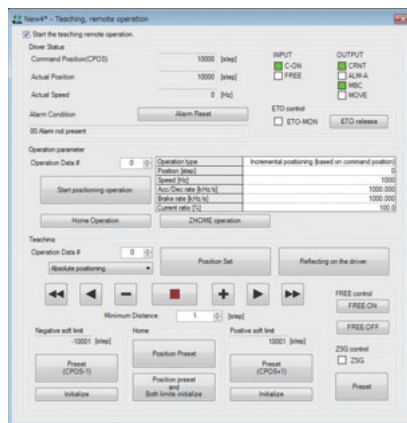

Multi-Monitoring Compatible

Multi-monitoring enables remote operation or teaching while monitoring.

Various Monitoring Functions

I/O Monitoring

The status of the I/O wired to the driver can be checked on a computer. This can be used for post-wiring I/O checks or I/O checks during operation.

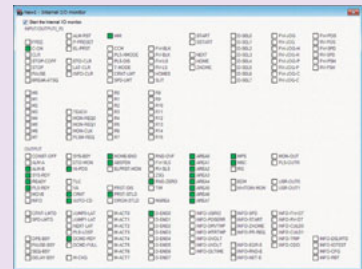

Waveform Monitoring

The operating status of the motor (such as command speed and motor load factor) can be checked from an oscilloscope-like image. This can be used for equipment start-up and adjustment.

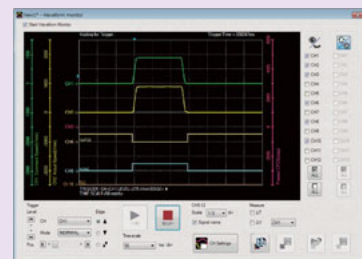

Alarm Monitoring

When an abnormality occurs, the details of the abnormality and the solution can be checked.

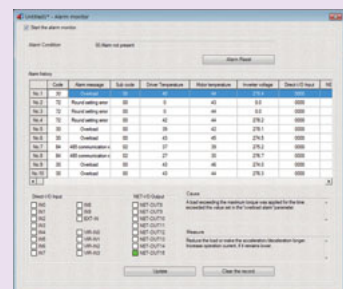

Standardized Wiring, Control, and Maintenance Parts

Various mechanical components equipped with α STEP AZ Series and α STEP AR Series are available.

Wiring, control, and maintenance parts have been standardized, since the same motors and drivers are equipped, which reduces the startup time and simplifies operation.

Battery-Free, Absolute Sensor Equipped
 α STEP AZ Series

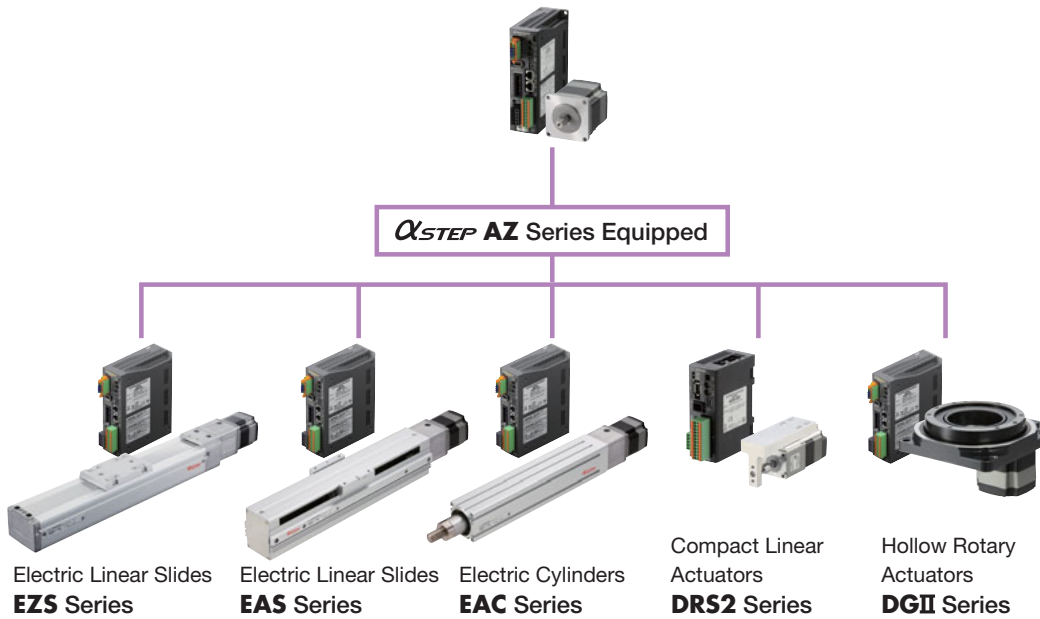

α STEP AR Series

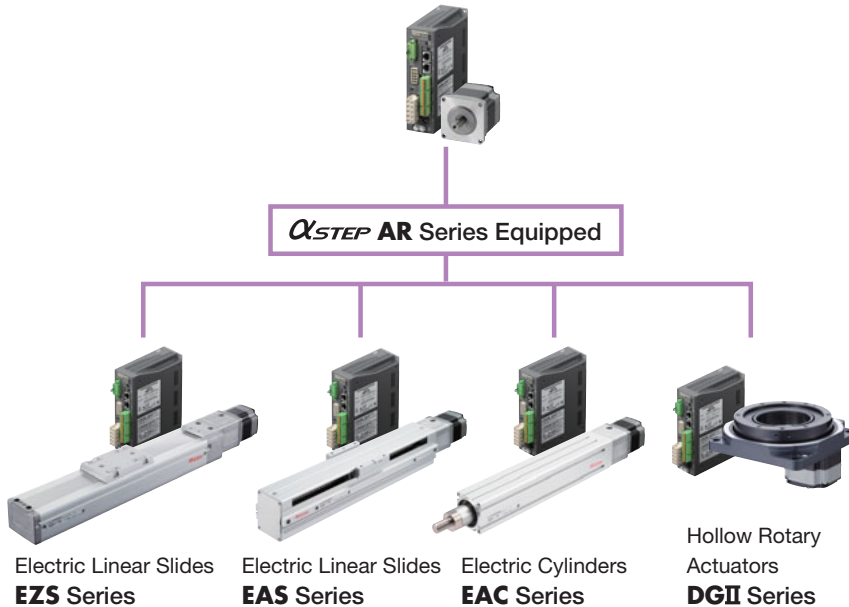

Merits of Standardization

● **Wiring Standardization**

Labor used for electrical design and wiring can be saved, since the I/O pin assignment is the same.

● **Control Standardization**

These products can be operated via the same method, since the control method is the same. For the network control, the remote I/O and the command code are also the same. The labor of making the program can be eliminated.

● **Maintenance Parts Standardization**

Maintenance parts can be minimized, since the motor, driver, and cable are common to all. Management costs (parts cost, management space) can be reduced.



Overview, Product Series

Electric Linear Slides

α STEP AZ/AR EAS

α STEP AZ/AR EZS

Electric Cylinders

α STEP AZ/AR EAC

Compact Linear Actuators

α STEP AZ DRS2

DRLII





Installation

Hollow Rotary Actuators

α STEP AZ/AR DGII

Accessories

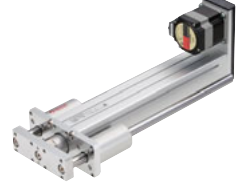
Product Line

Shaft Guide	Straight Type	Reversed Motor Type
<p>Without shaft guide</p> <p>Depending on the equipment, an external guide may be necessary.</p>		
<p>With Shaft Guide</p> <p>Designing an external guide and arranging the components is unnecessary, decreasing the startup time.</p>		
<p>With shaft guide cover</p> <p>Moving parts on the cylinder main unit side are protected, improving equipment safety. This is useful for grease splash prevention in the shaft guide section and the prevention of the infiltration of foreign particles in the linear bush section.</p>		

α STEP
AZ
Equipped

α STEP
AR
Equipped

The image below shows a three axes system using the electric linear slide **EAS** Series on the X-Y axis and the electric cylinder **EAC** Series on the Z axis.

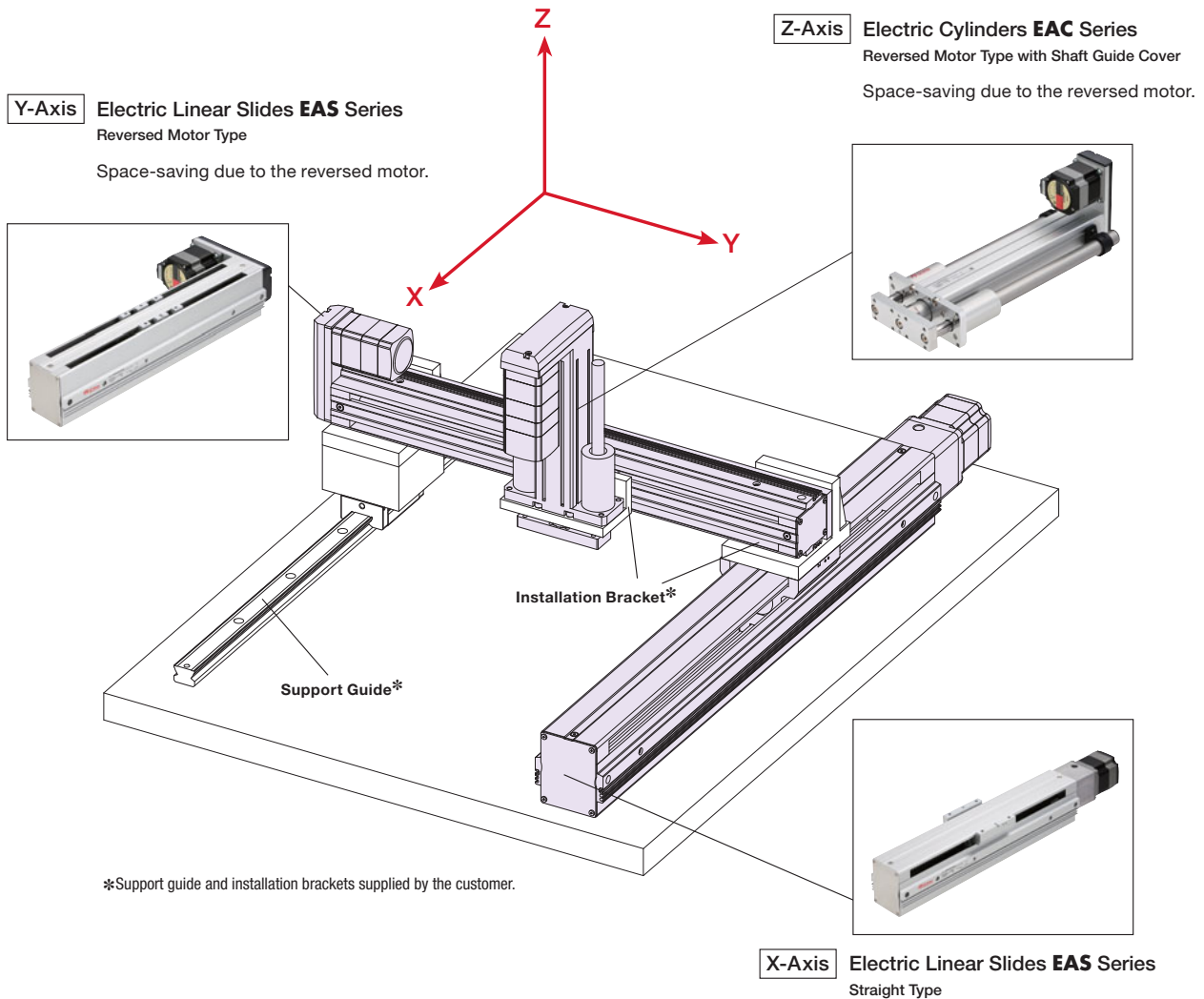

How to Read Specifications Table

Electric Linear Cylinder Specifications

① Drive Method	Ball Screw	② Repetitive Positioning Accuracy [mm]	±0.02		③ Min. Traveling Amount [mm]	0.01		④ Dynamic Permissible Moment [N·m]	Me: 1.3	Mv: 1.3	Mr: 0.6
						⑤ Static Permissible Moment [N·m]			Me: 3.7	Mv: 3.7	Mr: 3.0
Product Name	④ Lead Screw Pitch [mm]	⑦ Transportable Mass [kg]		⑧ Thrust [N]	⑨ Push Force [N]	⑩ Holding Force [N]	⑪ Maximum Speed [mm/s]				
		Horizontal	Vertical								
EAC4W-D-⑤-AZAC ⑨-⑩-⑪	12	~15	—	~70	100	70	600				
EAC4W-D-⑤-AZMC ⑨-⑩-⑪			~6								
EAC4W-E-⑤-AZAC ⑨-⑩-⑪	6	~30	—	~140	200	140	300				
EAC4W-E-⑤-AZMC ⑨-⑩-⑪			~13								

① Drive Method

Mechanism used to convert motor rotation to linear motion.

② Repetitive Positioning Accuracy

A value indicating the amount of error that is generated when positioning is performed repeatedly to the same position in the same direction. The repetitive positioning accuracy is measured at a constant temperature under a constant load.

③ Min. Traveling Amount

The minimum distant that the rod travels. (Factory setting)

④ Dynamic Permissible Moment*

The load moment acts on the linear guide if the load position is offset from the center of the rod.
The direction of action applies to three directions (pitching (MP), yawing (MY), and rolling (MR)) depending on the position of the offset.
The dynamic permissible moment is the moment allowed during operation.

⑤ Static Permissible Moment*

The load moment acts on the linear guide if the load position is offset from the center of the rod.
The direction of action applies to three directions (pitching (MP), yawing (MY), and rolling (MR)) depending on the position of the offset.
The static permissible moment is the moment allowed during static conditions.

④ Lead Screw Pitch

Distance the rod moves linearly in one motor rotation.

⑦ Transportable Mass

- Horizontal Direction
Mass that can be moved under operating performance in the horizontal direction of the electric cylinder.
- Vertical Direction
Mass that can be moved under operating performance in the vertical direction of the electric cylinder.

⑧ Thrust

Force from the rod that pushes the load when speed is constant.

⑨ Push Force

The pressure applied to the load during the pushing operation.

⑩ Holding Force

Holding force when the motor is stopped or when the electromagnetic brake is operating, while power is supplied.

⑪ Maximum Speed

Maximum speed allowed when transporting the maximum transportable mass.

Overview, Product Series

Electric Linear Slides

Q^{STEP} AZ/AR EAS

Q^{STEP} AZ/AR EZS

Electric Cylinders

Q^{STEP} AZ/AR EAC

Compact Linear Actuators

Q^{STEP} AZ DRS2

DRLII

Installation

Hollow Rotary Actuators

Q^{STEP} AZ/AR DGII

Accessories

* The electric cylinders have specifications only for those with shaft guide cover.

Electric Cylinders

EAC Series α STEP AZ Equipped

<Additional Information>

- Technical reference → Page H-1
- Regulations & Standards → Page I-2

α STEP
AZ
Equipped

Product Line

α STEP
AR
Equipped

● AC Input

◇ Product Number

① Series Name	② Motor Orientation	③ Shaft Guide	④ Lead Screw Pitch	⑤ Stroke	⑥ Motor	⑦ Motor Type	⑧ Power Supply Input*1	⑨ Driver Type	⑩ Connection Cable*2	⑪ Shaft Guide Cover
EAC4	R	W	D	05	AZ	A	C	D	3	G
EAC4 EAC6	R: Reversed Motor Type Blank: Straight Type	W: With Shaft Guide Blank: No Shaft Guide	D: 12 mm E: 6 mm	05: 50 mm 10: 100 mm 15: 150 mm ~ 30: 300 mm (50 mm increments)	AZ Series	A: Single Shaft M: With Electromagnetic Brake	C: Single-Phase 200-240 VAC	D: Built-in Controller Type Blank: Pulse Input Type	Number: Included Connection Cable Length 1: 1 m 2: 2 m 3: 3 m Blank: Connection cable is not included	G: With Shaft Guide Cover Blank: No Shaft Guide Cover

*1 For the single-phase 100-120 VAC models and three-phase 200-240 VAC models, please contact the nearest Oriental Motor sales office.

*2 Connection cables longer than 3 m are available as accessories (sold separately).

Connection Cable Set → Page E-258

◇ **EAC4** Straight Type/Reversed Motor Type

The prices are the same even if ② motor orientation (R, Blank), ④ lead screw pitch (D, E) are different.

⑨ Driver Type (D, Blank)	Built-in Controller Type (D)				Pulse Input Type (Blank)				
	Single Shaft (A)		With Electromagnetic Brake (M)		Single Shaft (A)		With Electromagnetic Brake (M)		
⑦ Motor Type (A, M)	Included (1, 2, 3)	Not Included	Included (1, 2, 3)	Not Included	Included (1, 2, 3)	Not Included	Included (1, 2, 3)	Not Included	
⑩ Connection Cable (1, 2, 3, Blank)									
⑤ Stroke	50 mm (05)	€976.00	€946.00	€1,134.00	€1,104.00	€926.00	€896.00	€1,084.00	€1,054.00
	100 mm (10)	€976.00	€946.00	€1,134.00	€1,104.00	€926.00	€896.00	€1,084.00	€1,054.00
	150 mm (15)	€987.00	€957.00	€1,145.00	€1,115.00	€937.00	€907.00	€1,095.00	€1,065.00
	200 mm (20)	€987.00	€957.00	€1,145.00	€1,115.00	€937.00	€907.00	€1,095.00	€1,065.00
	250 mm (25)	€998.00	€968.00	€1,157.00	€1,127.00	€948.00	€918.00	€1,107.00	€1,077.00
300 mm (30)	€998.00	€968.00	€1,157.00	€1,127.00	€948.00	€918.00	€1,107.00	€1,077.00	

◇ **EAC4** Straight Type/Reversed Motor Type with Shaft Guide

The prices are the same even if ② motor orientation (R, Blank), ④ lead screw pitch (D, E) are different.

⑨ Driver Type (D, Blank)	Built-in Controller Type (D)				Pulse Input Type (Blank)				
	Single Shaft (A)		With Electromagnetic Brake (M)		Single Shaft (A)		With Electromagnetic Brake (M)		
⑦ Motor Type (A, M)	Included (1, 2, 3)	Not Included	Included (1, 2, 3)	Not Included	Included (1, 2, 3)	Not Included	Included (1, 2, 3)	Not Included	
⑩ Connection Cable (1, 2, 3, Blank)									
⑤ Stroke	50 mm (05)	€1,168.00	€1,138.00	€1,326.00	€1,296.00	€1,118.00	€1,088.00	€1,276.00	€1,246.00
	100 mm (10)	€1,168.00	€1,138.00	€1,326.00	€1,296.00	€1,118.00	€1,088.00	€1,276.00	€1,246.00
	150 mm (15)	€1,179.00	€1,149.00	€1,337.00	€1,307.00	€1,129.00	€1,099.00	€1,287.00	€1,257.00
	200 mm (20)	€1,179.00	€1,149.00	€1,337.00	€1,307.00	€1,129.00	€1,099.00	€1,287.00	€1,257.00
	250 mm (25)	€1,191.00	€1,161.00	€1,349.00	€1,319.00	€1,141.00	€1,111.00	€1,299.00	€1,269.00
300 mm (30)	€1,191.00	€1,161.00	€1,349.00	€1,319.00	€1,141.00	€1,111.00	€1,299.00	€1,269.00	

◇ **EAC4** Straight Type/Reversed Motor Type with Shaft Guide Cover

The prices are the same even if ② motor orientation (R, Blank), ④ lead screw pitch (D, E) are different.

⑨ Driver Type (D, Blank)	Built-in Controller Type (D)				Pulse Input Type (Blank)				
	Single Shaft (A)		With Electromagnetic Brake (M)		Single Shaft (A)		With Electromagnetic Brake (M)		
⑦ Motor Type (A, M)	Included (1, 2, 3)	Not Included	Included (1, 2, 3)	Not Included	Included (1, 2, 3)	Not Included	Included (1, 2, 3)	Not Included	
⑩ Connection Cable (1, 2, 3, Blank)									
⑤ Stroke	50 mm (05)	€1,191.00	€1,161.00	€1,349.00	€1,319.00	€1,141.00	€1,111.00	€1,299.00	€1,269.00
	100 mm (10)	€1,191.00	€1,161.00	€1,349.00	€1,319.00	€1,141.00	€1,111.00	€1,299.00	€1,269.00
	150 mm (15)	€1,202.00	€1,172.00	€1,360.00	€1,330.00	€1,152.00	€1,122.00	€1,310.00	€1,280.00
	200 mm (20)	€1,202.00	€1,172.00	€1,360.00	€1,330.00	€1,152.00	€1,122.00	€1,310.00	€1,280.00
	250 mm (25)	€1,213.00	€1,183.00	€1,371.00	€1,341.00	€1,163.00	€1,133.00	€1,321.00	€1,291.00
300 mm (30)	€1,213.00	€1,183.00	€1,371.00	€1,341.00	€1,163.00	€1,133.00	€1,321.00	€1,291.00	

◇ EAC6 Straight Type/Reversed Motor Type

The prices are the same even if ② motor orientation (R, Blank), ④ lead screw pitch (D, E) are different.

⑨ Driver Type (D, Blank)	Built-in Controller Type (D)				Pulse Input Type (Blank)				
⑦ Motor Type (A, M)	Single Shaft (A)		With Electromagnetic Brake (M)		Single Shaft (A)		With Electromagnetic Brake (M)		
⑩ Connection Cable (1, 2, 3, Blank)	Included (1, 2, 3)	Not Included	Included (1, 2, 3)	Not Included	Included (1, 2, 3)	Not Included	Included (1, 2, 3)	Not Included	
⑤ Stroke	50 mm (05)	€1,044.00	€1,014.00	€1,247.00	€1,217.00	€994.00	€964.00	€1,197.00	€1,167.00
	100 mm (10)	€1,044.00	€1,014.00	€1,247.00	€1,217.00	€994.00	€964.00	€1,197.00	€1,167.00
	150 mm (15)	€1,055.00	€1,025.00	€1,258.00	€1,228.00	€1,005.00	€975.00	€1,208.00	€1,178.00
	200 mm (20)	€1,055.00	€1,025.00	€1,258.00	€1,228.00	€1,005.00	€975.00	€1,208.00	€1,178.00
	250 mm (25)	€1,066.00	€1,036.00	€1,270.00	€1,240.00	€1,016.00	€986.00	€1,220.00	€1,190.00
	300 mm (30)	€1,066.00	€1,036.00	€1,270.00	€1,240.00	€1,016.00	€986.00	€1,220.00	€1,190.00

◇ EAC6 Straight Type/Reversed Motor Type with Shaft Guide

The prices are the same even if ② motor orientation (R, Blank), ④ lead screw pitch (D, E) are different.

⑨ Driver Type (D, Blank)	Built-in Controller Type (D)				Pulse Input Type (Blank)				
⑦ Motor Type (A, M)	Single Shaft (A)		With Electromagnetic Brake (M)		Single Shaft (A)		With Electromagnetic Brake (M)		
⑩ Connection Cable (1, 2, 3, Blank)	Included (1, 2, 3)	Not Included	Included (1, 2, 3)	Not Included	Included (1, 2, 3)	Not Included	Included (1, 2, 3)	Not Included	
⑤ Stroke	50 mm (05)	€1,270.00	€1,240.00	€1,473.00	€1,443.00	€1,220.00	€1,190.00	€1,423.00	€1,393.00
	100 mm (10)	€1,270.00	€1,240.00	€1,473.00	€1,443.00	€1,220.00	€1,190.00	€1,423.00	€1,393.00
	150 mm (15)	€1,281.00	€1,251.00	€1,484.00	€1,454.00	€1,231.00	€1,201.00	€1,434.00	€1,404.00
	200 mm (20)	€1,281.00	€1,251.00	€1,484.00	€1,454.00	€1,231.00	€1,201.00	€1,434.00	€1,404.00
	250 mm (25)	€1,292.00	€1,262.00	€1,496.00	€1,466.00	€1,242.00	€1,212.00	€1,446.00	€1,416.00
	300 mm (30)	€1,292.00	€1,262.00	€1,496.00	€1,466.00	€1,242.00	€1,212.00	€1,446.00	€1,416.00

◇ EAC6 Straight Type/Reversed Motor Type with Shaft Guide Cover

The prices are the same even if ② motor orientation (R, Blank), ④ lead screw pitch (D, E) are different.

⑨ Driver Type (D, Blank)	Built-in Controller Type (D)				Pulse Input Type (Blank)				
⑦ Motor Type (A, M)	Single Shaft (A)		With Electromagnetic Brake (M)		Single Shaft (A)		With Electromagnetic Brake (M)		
⑩ Connection Cable (1, 2, 3, Blank)	Included (1, 2, 3)	Not Included	Included (1, 2, 3)	Not Included	Included (1, 2, 3)	Not Included	Included (1, 2, 3)	Not Included	
⑤ Stroke	50 mm (05)	€1,292.00	€1,262.00	€1,496.00	€1,466.00	€1,242.00	€1,212.00	€1,446.00	€1,416.00
	100 mm (10)	€1,292.00	€1,262.00	€1,496.00	€1,466.00	€1,242.00	€1,212.00	€1,446.00	€1,416.00
	150 mm (15)	€1,304.00	€1,274.00	€1,507.00	€1,477.00	€1,254.00	€1,224.00	€1,457.00	€1,427.00
	200 mm (20)	€1,304.00	€1,274.00	€1,507.00	€1,477.00	€1,254.00	€1,224.00	€1,457.00	€1,427.00
	250 mm (25)	€1,315.00	€1,285.00	€1,518.00	€1,488.00	€1,265.00	€1,235.00	€1,468.00	€1,438.00
	300 mm (30)	€1,315.00	€1,285.00	€1,518.00	€1,488.00	€1,265.00	€1,235.00	€1,468.00	€1,438.00

Overview, Product Series

Electric Linear Slides

Q-STEP AZ/AR EAS

Q-STEP AZ/AR EZS

Electric Cylinders

Q-STEP AZ/AR EAC

Compact Linear Actuators

Q-STEP AZ DRS2

DRLII

Installation

Hollow Rotary Actuators

Q-STEP AZ/AR DGII

Accessories

● DC Input

◇ Product Number

① Series Name	② Motor Orientation	③ Shaft Guide	④ Lead Screw Pitch	⑤ Stroke	⑥ Motor	⑦ Motor Type	⑧ Power Supply Input	⑨ Driver Type	⑩ Connection Cable* ²	⑪ Shaft Guide Cover
EAC4	R	W	D	05	AZ	A	K	D	3	G
EAC2 EAC4 EAC6	R: Reversed Motor Type Blank: Straight Type	W: With Shaft Guide Blank: No Shaft type	D: 12 mm E: 6 mm F: 3 mm	05: 50 mm 10: 100 mm 15: 150 mm 30: 300 mm (50 mm increments)	AZ Series	A: Single Shaft M: With Electromagnetic Brake	K: 24 VDC/48 VDC* ¹	D: Built-in Controller Type Blank: Pulse Input Type	Number: Included Connection Cable Length 1: 1 m 2: 2 m 3: 3 m Blank: Connection cable is not included	G: With Shaft Guide Cover Blank: No Shaft Guide Cover

*1 **EAC2** only accepts 24 VDC input.

*2 Connection cables longer than 3 m are available as accessories (sold separately).
Connection Cable Set → Page E-260

◇ **EAC2** Straight Type

The prices are the same even if ④ lead screw pitch (**E, F**) are different.

⑨ Driver Type (D , Blank)	Built-in Controller Type (D)		Pulse Input Type (Blank)		
⑩ Connection Cable (1, 2, 3 , Blank)	Included (1, 2, 3)	Not Included	Included (1, 2, 3)	Not Included	
⑤ Stroke	50 mm (05)	€839.00	€809.00	€789.00	€759.00
	100 mm (10)	€839.00	€809.00	€789.00	€759.00
	150 mm (15)	€850.00	€820.00	€800.00	€770.00

◇ **EAC2** Straight Type with Shaft Guide Cover

The prices are the same even if ④ lead screw pitch (**E, F**) are different.

⑨ Driver Type (D , Blank)	Built-in Controller Type (D)		Pulse Input Type (Blank)		
⑩ Connection Cable (1, 2, 3 , Blank)	Included (1, 2, 3)	Not Included	Included (1, 2, 3)	Not Included	
⑤ Stroke	50 mm (05)	€1,031.00	€1,001.00	€981.00	€951.00
	100 mm (10)	€1,031.00	€1,001.00	€981.00	€951.00
	150 mm (15)	€1,042.00	€1,012.00	€992.00	€962.00

◇ **EAC4** Straight Type/Reversed Motor Type

The prices are the same even if ② motor orientation (**R**, Blank), ④ lead screw pitch (**D, E**) are different.

⑨ Driver Type (D , Blank)	Built-in Controller Type (D)				Pulse Input Type (Blank)				
	Single Shaft (A)		With Electromagnetic Brake (M)		Single Shaft (A)		With Electromagnetic Brake (M)		
⑦ Motor Type (A, M)	Single Shaft (A)		With Electromagnetic Brake (M)		Single Shaft (A)		With Electromagnetic Brake (M)		
⑩ Connection Cable (1, 2, 3 , Blank)	Included (1, 2, 3)	Not Included	Included (1, 2, 3)	Not Included	Included (1, 2, 3)	Not Included	Included (1, 2, 3)	Not Included	
⑤ Stroke	50 mm (05)	€856.00	€826.00	€1,014.00	€984.00	€806.00	€776.00	€964.00	€934.00
	100 mm (10)	€856.00	€826.00	€1,014.00	€984.00	€806.00	€776.00	€964.00	€934.00
	150 mm (15)	€867.00	€837.00	€1,025.00	€995.00	€817.00	€787.00	€975.00	€945.00
	200 mm (20)	€867.00	€837.00	€1,025.00	€995.00	€817.00	€787.00	€975.00	€945.00
	250 mm (25)	€878.00	€848.00	€1,037.00	€1,007.00	€828.00	€798.00	€987.00	€957.00
	300 mm (30)	€878.00	€848.00	€1,037.00	€1,007.00	€828.00	€798.00	€987.00	€957.00

◇ **EAC4** Straight Type/Reversed Motor Type with Shaft Guide

The prices are the same even if ② motor orientation (**R**, Blank), ④ lead screw pitch (**D, E**) are different.

⑨ Driver Type (D , Blank)	Built-in Controller Type (D)				Pulse Input Type (Blank)				
	Single Shaft (A)		With Electromagnetic Brake (M)		Single Shaft (A)		With Electromagnetic Brake (M)		
⑦ Motor Type (A, M)	Single Shaft (A)		With Electromagnetic Brake (M)		Single Shaft (A)		With Electromagnetic Brake (M)		
⑩ Connection Cable (1, 2, 3 , Blank)	Included (1, 2, 3)	Not Included	Included (1, 2, 3)	Not Included	Included (1, 2, 3)	Not Included	Included (1, 2, 3)	Not Included	
⑤ Stroke	50 mm (05)	€1,048.00	€1,018.00	€1,206.00	€1,176.00	€998.00	€968.00	€1,156.00	€1,126.00
	100 mm (10)	€1,048.00	€1,018.00	€1,206.00	€1,176.00	€998.00	€968.00	€1,156.00	€1,126.00
	150 mm (15)	€1,059.00	€1,029.00	€1,217.00	€1,187.00	€1,009.00	€979.00	€1,167.00	€1,137.00
	200 mm (20)	€1,059.00	€1,029.00	€1,217.00	€1,187.00	€1,009.00	€979.00	€1,167.00	€1,137.00
	250 mm (25)	€1,071.00	€1,041.00	€1,229.00	€1,199.00	€1,021.00	€991.00	€1,179.00	€1,149.00
	300 mm (30)	€1,071.00	€1,041.00	€1,229.00	€1,199.00	€1,021.00	€991.00	€1,179.00	€1,149.00

◇ **EAC4** Straight Type/Reversed Motor Type with Shaft Guide Cover

The prices are the same even if ② motor orientation (**R**, Blank), ④ lead screw pitch (**D, E**) are different.

⑨ Driver Type (D , Blank)	Built-in Controller Type (D)				Pulse Input Type (Blank)				
	Single Shaft (A)		With Electromagnetic Brake (M)		Single Shaft (A)		With Electromagnetic Brake (M)		
⑦ Motor Type (A, M)	Single Shaft (A)		With Electromagnetic Brake (M)		Single Shaft (A)		With Electromagnetic Brake (M)		
⑩ Connection Cable (1, 2, 3 , Blank)	Included (1, 2, 3)	Not Included	Included (1, 2, 3)	Not Included	Included (1, 2, 3)	Not Included	Included (1, 2, 3)	Not Included	
⑤ Stroke	50 mm (05)	€1,071.00	€1,041.00	€1,229.00	€1,199.00	€1,021.00	€991.00	€1,179.00	€1,149.00
	100 mm (10)	€1,071.00	€1,041.00	€1,229.00	€1,199.00	€1,021.00	€991.00	€1,179.00	€1,149.00
	150 mm (15)	€1,082.00	€1,052.00	€1,240.00	€1,210.00	€1,032.00	€1,002.00	€1,190.00	€1,160.00
	200 mm (20)	€1,082.00	€1,052.00	€1,240.00	€1,210.00	€1,032.00	€1,002.00	€1,190.00	€1,160.00
	250 mm (25)	€1,093.00	€1,063.00	€1,251.00	€1,221.00	€1,043.00	€1,013.00	€1,201.00	€1,171.00
	300 mm (30)	€1,093.00	€1,063.00	€1,251.00	€1,221.00	€1,043.00	€1,013.00	€1,201.00	€1,171.00

◇ EAC6 Straight Type/Reversed Motor Type

The prices are the same even if ② motor orientation (R, Blank), ④ lead screw pitch (D, E) are different.

⑨ Driver Type (D, Blank)	Built-in Controller Type (D)				Pulse Input Type (Blank)				
⑦ Motor Type (A, M)	Single Shaft (A)		With Electromagnetic Brake (M)		Single Shaft (A)		With Electromagnetic Brake (M)		
⑩ Connection Cable (1, 2, 3, Blank)	Included (1, 2, 3)	Not Included	Included (1, 2, 3)	Not Included	Included (1, 2, 3)	Not Included	Included (1, 2, 3)	Not Included	
⑤ Stroke	50 mm (05)	€924.00	€894.00	€1,127.00	€1,097.00	€874.00	€844.00	€1,077.00	€1,047.00
	100 mm (10)	€924.00	€894.00	€1,127.00	€1,097.00	€874.00	€844.00	€1,077.00	€1,047.00
	150 mm (15)	€935.00	€905.00	€1,138.00	€1,108.00	€885.00	€855.00	€1,088.00	€1,058.00
	200 mm (20)	€935.00	€905.00	€1,138.00	€1,108.00	€885.00	€855.00	€1,088.00	€1,058.00
	250 mm (25)	€946.00	€916.00	€1,150.00	€1,120.00	€896.00	€866.00	€1,100.00	€1,070.00
	300 mm (30)	€946.00	€916.00	€1,150.00	€1,120.00	€896.00	€866.00	€1,100.00	€1,070.00

◇ EAC6 Straight Type/Reversed Motor Type with Shaft Guide

The prices are the same even if ② motor orientation (R, Blank), ④ lead screw pitch (D, E) are different.

⑨ Driver Type (D, Blank)	Built-in Controller Type (D)				Pulse Input Type (Blank)				
⑦ Motor Type (A, M)	Single Shaft (A)		With Electromagnetic Brake (M)		Single Shaft (A)		With Electromagnetic Brake (M)		
⑩ Connection Cable (1, 2, 3, Blank)	Included (1, 2, 3)	Not Included	Included (1, 2, 3)	Not Included	Included (1, 2, 3)	Not Included	Included (1, 2, 3)	Not Included	
⑤ Stroke	50 mm (05)	€1,150.00	€1,120.00	€1,353.00	€1,323.00	€1,100.00	€1,070.00	€1,303.00	€1,273.00
	100 mm (10)	€1,150.00	€1,120.00	€1,353.00	€1,323.00	€1,100.00	€1,070.00	€1,303.00	€1,273.00
	150 mm (15)	€1,161.00	€1,131.00	€1,364.00	€1,334.00	€1,111.00	€1,081.00	€1,314.00	€1,284.00
	200 mm (20)	€1,161.00	€1,131.00	€1,364.00	€1,334.00	€1,111.00	€1,081.00	€1,314.00	€1,284.00
	250 mm (25)	€1,172.00	€1,142.00	€1,376.00	€1,346.00	€1,122.00	€1,092.00	€1,326.00	€1,296.00
	300 mm (30)	€1,172.00	€1,142.00	€1,376.00	€1,346.00	€1,122.00	€1,092.00	€1,326.00	€1,296.00

◇ EAC6 Straight Type/Reversed Motor Type with Shaft Guide Cover

The prices are the same even if ② motor orientation (R, Blank), ④ lead screw pitch (D, E) are different.

⑨ Driver Type (D, Blank)	Built-in Controller Type (D)				Pulse Input Type (Blank)				
⑦ Motor Type (A, M)	Single Shaft (A)		With Electromagnetic Brake (M)		Single Shaft (A)		With Electromagnetic Brake (M)		
⑩ Connection Cable (1, 2, 3, Blank)	Included (1, 2, 3)	Not Included	Included (1, 2, 3)	Not Included	Included (1, 2, 3)	Not Included	Included (1, 2, 3)	Not Included	
⑤ Stroke	50 mm (05)	€1,172.00	€1,142.00	€1,376.00	€1,346.00	€1,122.00	€1,092.00	€1,326.00	€1,296.00
	100 mm (10)	€1,172.00	€1,142.00	€1,376.00	€1,346.00	€1,122.00	€1,092.00	€1,326.00	€1,296.00
	150 mm (15)	€1,184.00	€1,154.00	€1,387.00	€1,357.00	€1,134.00	€1,104.00	€1,337.00	€1,307.00
	200 mm (20)	€1,184.00	€1,154.00	€1,387.00	€1,357.00	€1,134.00	€1,104.00	€1,337.00	€1,307.00
	250 mm (25)	€1,195.00	€1,165.00	€1,398.00	€1,368.00	€1,145.00	€1,115.00	€1,348.00	€1,318.00
	300 mm (30)	€1,195.00	€1,165.00	€1,398.00	€1,368.00	€1,145.00	€1,115.00	€1,348.00	€1,318.00

Overview, Product Series

Electric Linear Slides

Q-STEP AZ/AR EAS

Q-STEP AZ/AR EZS

Electric Cylinders

Q-STEP AZ/AR EAC

Compact Linear Actuators

Q-STEP AZ DRS2

DRLII

Installation

Hollow Rotary Actuators

Q-STEP AZ/AR DGII

Accessories

System Configuration

When Equipped with AZ Series, Built-in Controller Type with an Electromagnetic Brake

(Information for AC input type and DC input type are both provided. The photos show the product with an AC input type.)

An example of a configuration using I/O control or RS-485 communication is shown below.

*1 Not supplied.

*2 Not required for products for DC input.

*3 Only products in which a connection cable is included.

α STEP
AZ
Equipped

α STEP
AR
Equipped

Accessories (Sold separately)

When extending the distance between the motor and the driver without using the included connection cable*3

(For Motor) (For Encoder) (For Electromagnetic Brake)

Connection Cable Sets
Flexible Connection Cable Sets
AC Power Supply Input → Page E-258
DC Power Supply Input → Page E-260

When extending the distance between the motor and the driver using the included connection cable*3

(For Motor) (For Encoder) (For Electromagnetic Brake)

Extension Cable Sets
Flexible Extension Cable Sets
AC Power Supply Input → Page E-258
DC Power Supply Input → Page E-260

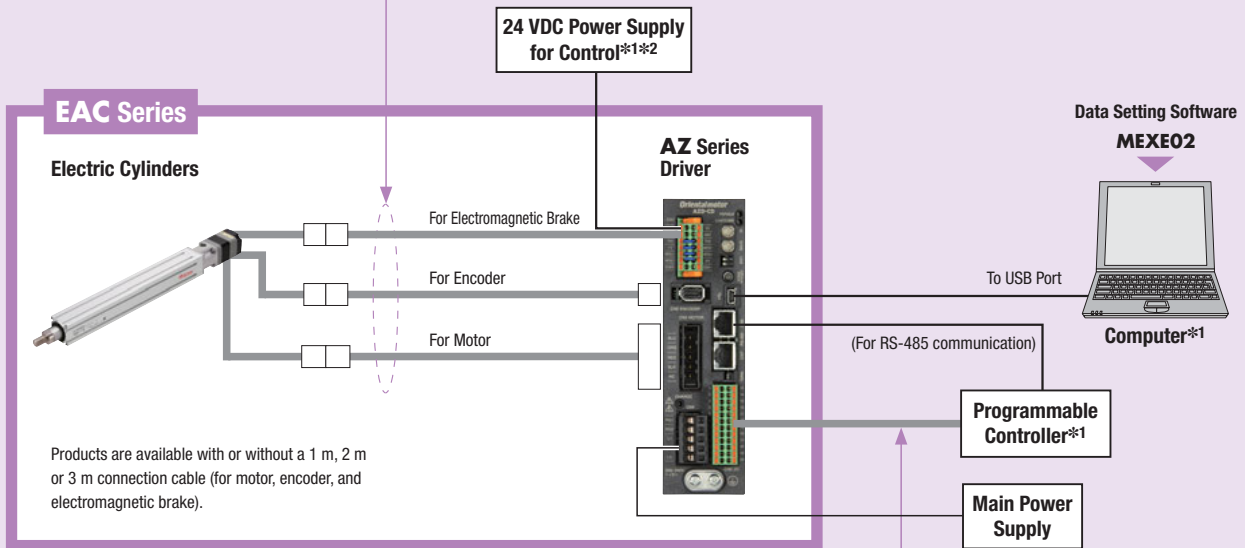

Accessories (Sold separately)

Installation Plates
→ Page E-282

RS-485 Communication Cables
→ Page E-263

General-Purpose Cables for I/O Signals
→ Page E-263

Peripheral Products (Sold separately)

Network Converter
→ Page F-10

- The functions and operating method are the same as for the stepper motor **AZ** series. For the functions and operating method, refer to the operating manual for the **AZ** Series (for drivers and functions).
- The operating manual for functions is not supplied with the product. Please contact the nearest Oriental Motor sales office, or download it from the Oriental Motor website. www.orientalmotor.eu

Example of System Configuration

EAC Series	+	Sold Separately
EAC4-D05-AZMCD-3		General-Purpose Cables for I/O Signals (1 m)
€1,134.00		CC16D010B-1
		€18.00

• The system configuration shown above is an example. Other combinations are also available.

● When Equipped with AZ Series, Pulse Input Type with an Electromagnetic Brake

(Information for AC input type and DC input type are both provided. The photos show the product with an AC input type.)

An example of a single-axis system configuration with the **SCX11** controller is shown below.

*1 Not supplied.

*2 Not required for products for DC input.

*3 Only products in which a connection cable is included.

Overview,
Product
Series

Electric
Linear
Slides

Q^{STEP}
AZ/AR
EAS

Q^{STEP}
AZ/AR
EES

Electric
Cylinders

Q^{STEP}
AZ/AR
EAC

Compact
Linear
Actuators

Q^{STEP}
AZ
DRS2

DRLII

Installation

Hollow
Rotary
Actuators

Q^{STEP}
AZ/AR
DGII

Accessories

Accessories (Sold separately)

When extending the distance between the motor and the driver without using the included connection cable*3

(For Motor) (For Encoder) (For Electromagnetic Brake)

Connection Cable Sets
Flexible Connection Cable Sets
AC Power Supply Input → Page E-258
DC Power Supply Input → Page E-260

When extending the distance between the motor and the driver using the included connection cable*3

(For Motor) (For Encoder) (For Electromagnetic Brake)

Extension Cable Sets
Flexible Extension Cable Sets
AC Power Supply Input → Page E-258
DC Power Supply Input → Page E-260

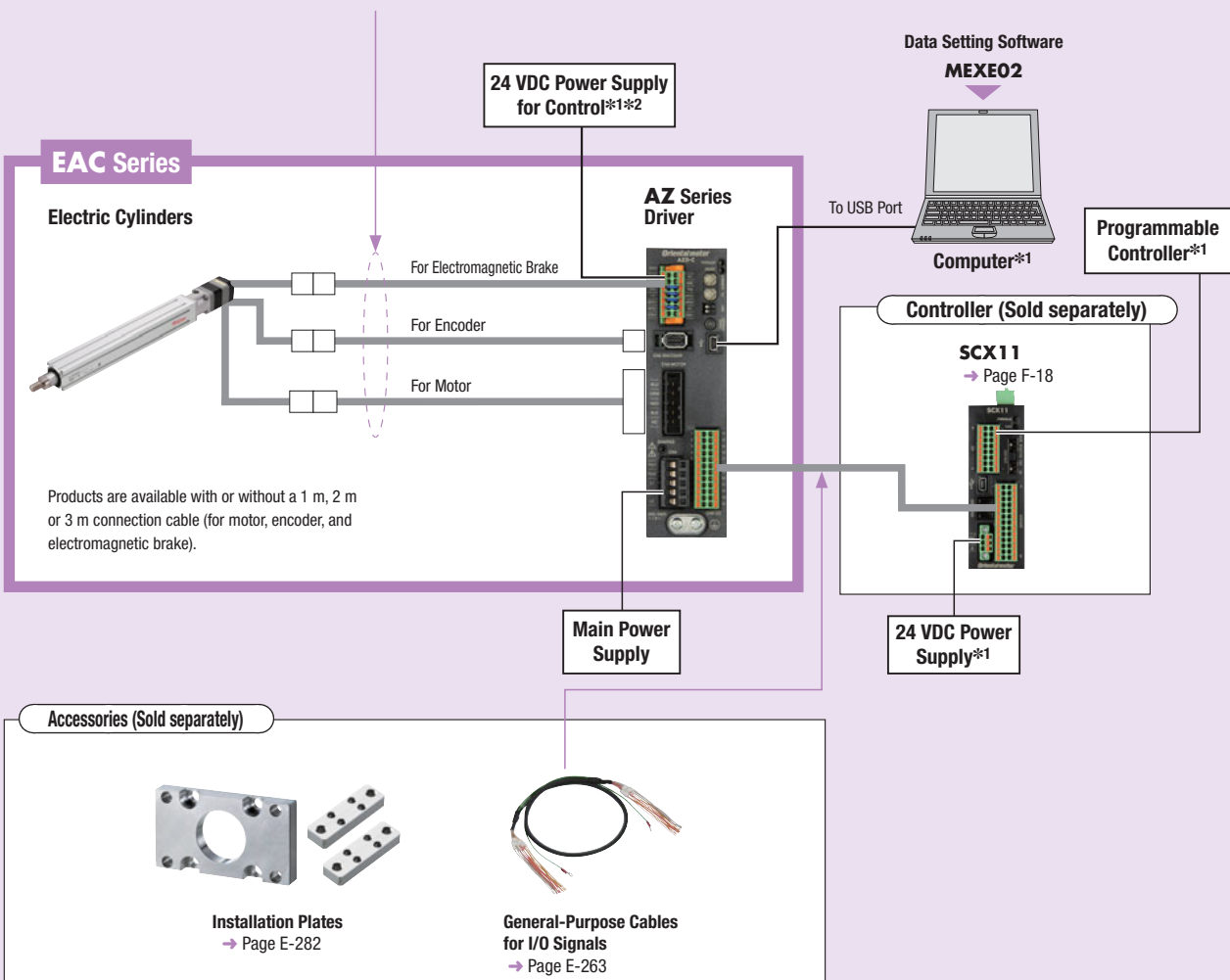

● The functions and operating method are the same as for the stepper motor **AZ** series. For the functions and operating method, refer to the operating manual for the **AZ** Series (for drivers and functions).

● The operating manual for functions is not supplied with the product. Please contact the nearest Oriental Motor sales office, or download it from the Oriental Motor website. www.orientalmotor.eu

● Example of System Configuration

EAC Series	+		Sold Separately	
EAC4-D05-AZMC-3 €1,084.00		Controller		General-Purpose Cables for I/O Signals (1 m)
		SCX11 €215.00		CC16D010B-1 €18.00

● The system configuration shown above is an example. Other combinations are also available.

EAC2: Frame Size 28 mm × 28 mm 24 VDC Input Straight Type

α STEP
AZ
Equipped

α STEP
AR
Equipped

Maximum Transportable Mass: Horizontal 15 kg/Vertical 5 kg

Stroke: 50 to 150 mm (50 mm Increments)



Electric Cylinder Specifications

Drive Method	Ball Screw	Repetitive Positioning Accuracy [mm]	±0.02		Min. Traveling Amount [mm]	0.01	
Product Name	Lead Screw Pitch [mm]	Transportable Mass [kg]*		Thrust [N]	Push Force [N]	Holding Force [N]	Maximum Speed [mm/s]
		Horizontal	Vertical				
EAC2-E $\text{\textcircled{5}}$ -AZAK $\text{\textcircled{9}}$ - $\text{\textcircled{10}}$	6	~7.5	~2.5	~25	40	25	300
EAC2-F $\text{\textcircled{5}}$ -AZAK $\text{\textcircled{9}}$ - $\text{\textcircled{10}}$	3	~15	~5	~50	80	50	150

*The transportable mass specifications apply when using external linear guide.

● A symbol or number is specified where $\text{\textcircled{5}}$ $\text{\textcircled{9}}$ $\text{\textcircled{10}}$ are located in the product name. For details, please refer to "◇Product Number" on page E-136.

● For details on how to read the specification table, please refer to "How to Read Specifications" on page E-133.

Note

- Loads and external forces cannot be held in the vertical direction since the holding force is lost in nonenergized state.
- Do not apply a radial load or load moment to an electric linear cylinder rod. A simple anti-spin mechanism is already provided, but always be sure to provide an external guide.
- The maximum speed may be lowered according to the ambient temperature and the length of the motor cable.

Positioning Distance – Positioning Time

Check the positioning time (reference) from the positioning distance.

Refer to page E-172 for the operating speed and acceleration.

● Lead Screw Pitch: 6 mm

◇ Horizontal Direction Installation

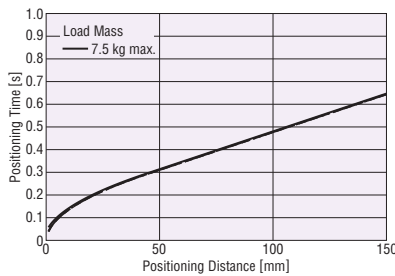

◇ Vertical Direction Installation

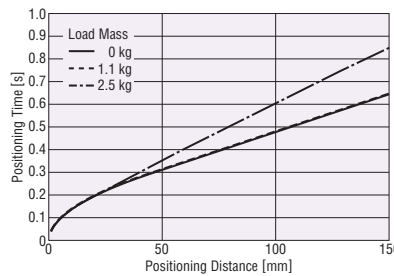

● Lead Screw Pitch: 3 mm

◇ Horizontal Direction Installation

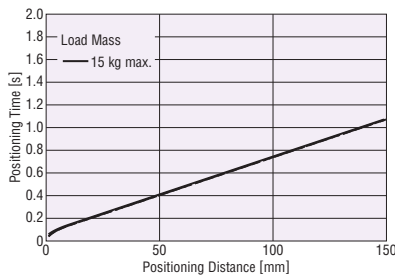

◇ Vertical Direction Installation

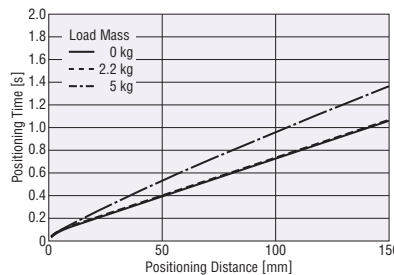

Note

- Starting speed should be 6 mm/s max.

Operating Speed – Thrust

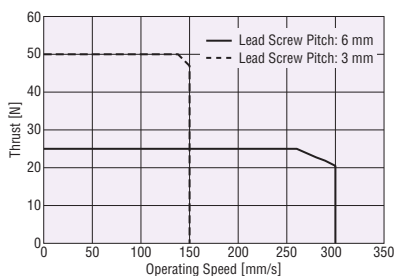

Dimensions

- Electric Cylinder → Page E-160
- Driver → Page E-170

Connection and Operation

- Built-in Controller Type → Page A-205
- Pulse Input Type → Page A-209

EAC2W: Frame Size 28 mm × 86 mm 24 VDC Input Straight Type with Shaft Guide Cover

Maximum Transportable Mass: Horizontal 15 kg/Vertical 4.5 kg
Stroke: 50 to 150 mm (50 mm Increments)



Electric Cylinder Specifications

Drive Method	Ball Screw	Repetitive Positioning Accuracy [mm]	±0.02	Min. Traveling Amount [mm]	0.01	Dynamic Permissible Moment [N·m]	M _p : 0.7	M _v : 0.7	M _r : 0.3
						Static Permissible Moment [N·m]	M _s : 1.4	M _v : 1.4	M _r : 0.6

Product Name	Lead Screw Pitch [mm]	Transportable Mass [kg]*		Thrust [N]	Push Force [N]	Holding Force [N]	Maximum Speed [mm/s]
		Horizontal	Vertical				
EAC2W-E ⑤-AZAK ⑨-⑩-⑪	6	~7.5	~2.0	~25	40	25	300
EAC2W-F ⑤-AZAK ⑨-⑩-⑪	3	~15	~4.5	~50	80	50	150

*The transportable mass specifications apply when using external linear guide. When the linear guide is not used, refer to "Horizontal Transportable Mass".

● A symbol or number is specified where ⑤ ⑨ ⑩ ⑪ are located in the product name. For details, please refer to "◇Product Number" on page E-136.

● For details on how to read the specification table, please refer to "How to Read Specifications" on page E-133.

Note

- Loads and external forces cannot be held in the vertical direction since the holding force is lost in nonenergized state.
- The maximum speed may be lowered according to the ambient temperature and the length of the motor cable.

Positioning Distance – Positioning Time

Check the positioning time (reference) from the positioning distance.
Refer to page E-173 for the operating speed and acceleration.

● Lead Screw Pitch: 6 mm

◇ Horizontal Direction Installation

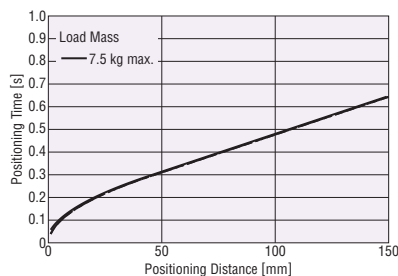

◇ Vertical Direction Installation

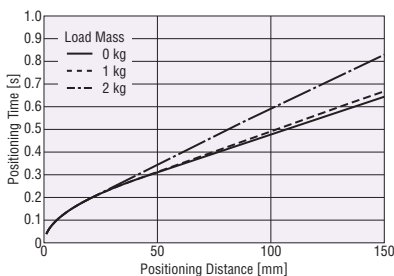

● Lead Screw Pitch: 3 mm

◇ Horizontal Direction Installation

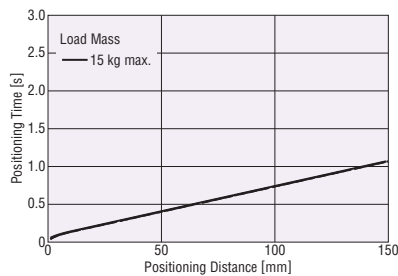

◇ Vertical Direction Installation

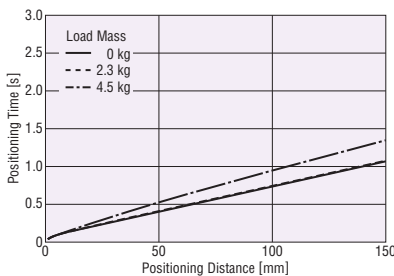

Note

- Starting speed should be 6 mm/s max.

Operating Speed – Thrust

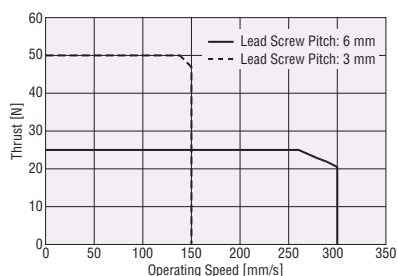

Horizontal Transportable Mass

◇ Positioning Distance – Horizontal Transportable Mass

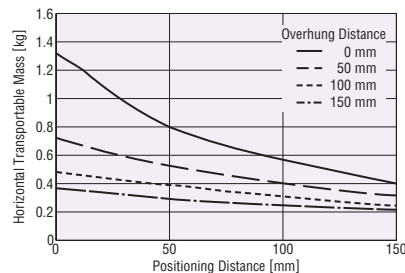

Products equipped with a shaft guide can transport loads that are attached directly to the body of the product. Check the horizontal transportable mass in the graph above.

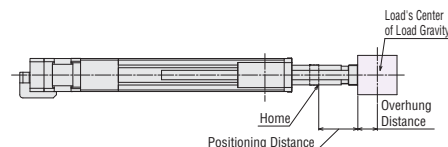

- The positioning distance means the distance from the home position.
- The overhang distance means the distance that the load extends beyond the installation surface.

Dimensions

- Electric Cylinder → Page E-161
- Driver → Page E-170

Connection and Operation

- Built-in Controller Type → Page A-205
- Pulse Input Type → Page A-209

Overview, Product Series

Electric Linear Slides

Q/STEP AZ/AR EAS

Q/STEP AZ/AR EZS

Electric Cylinders

Q/STEP AZ/AR EAC

Compact Linear Actuators

Q/STEP AZ DRS2

DRLII

Installation

Hollow Rotary Actuators

Q/STEP AZ/AR DGII

Accessories

EAC4: Frame Size 42 mm × 42 mm AC Input Straight Type

α STEP
AZ
Equipped

α STEP
AR
Equipped

Maximum Transportable Mass: Horizontal 30 kg/Vertical 14 kg

Stroke: 50 to 300 mm (50 mm Increments)



Electric Cylinder Specifications

Drive Method	Ball Screw	Repetitive Positioning Accuracy [mm]	±0.02	Min. Traveling Amount [mm]	0.01		
Product Name	Lead Screw Pitch [mm]	Transportable Mass [kg]*		Thrust [N]	Push Force [N]	Holding Force [N]	Maximum Speed [mm/s]
		Horizontal	Vertical				
EAC4-D ^⑤ -AZAC ^{⑨-⑩}	12	~15	—	~70	100	70	600
EAC4-D ^⑤ -AZMC ^{⑨-⑩}			~7				
EAC4-E ^⑤ -AZAC ^{⑨-⑩}	6	~30	—	~140	200	140	300
EAC4-E ^⑤ -AZMC ^{⑨-⑩}			~14				

*The transportable mass specifications apply when using external linear guide.

● A symbol or number is specified where ⑤⑨⑩ are located in the product name. For details, please refer to "◇Product Number" on page E-134.

● For details on how to read the specification table, please refer to "How to Read Specifications" on page E-133.

Note

● Do not apply a radial load or load moment to an electric linear cylinder rod. A simple anti-spin mechanism is already provided, but always be sure to provide an external guide.

Positioning Distance – Positioning Time

Check the positioning time (reference) from the positioning distance.

Refer to page E-174 for the operating speed and acceleration.

● Lead Screw Pitch: 12 mm

◇ Horizontal Direction Installation

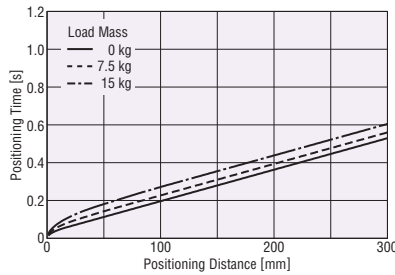

◇ Vertical Direction Installation

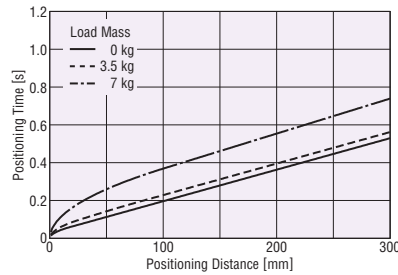

● Lead Screw Pitch: 6 mm

◇ Horizontal Direction Installation

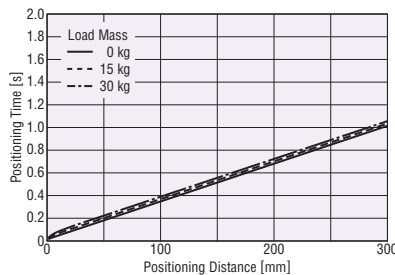

◇ Vertical Direction Installation

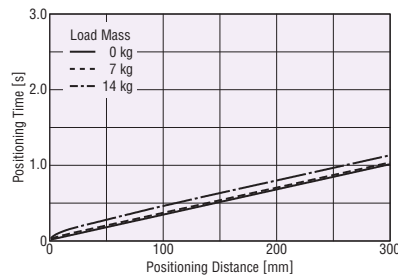

Note

● Starting speed should be 6 mm/s max.

Operating Speed – Thrust

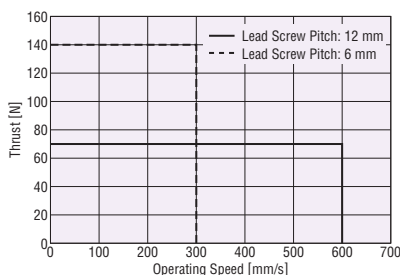

Dimensions

- Electric Cylinder → Page E-162
- Driver → Page E-170

Connection and Operation

- Built-in Controller Type → Page A-60
- Pulse Input Type → Page A-64

EAC4R: Frame Size 42 mm × 42 mm AC Input Reversed Motor Type

Maximum Transportable Mass: Horizontal 30 kg/Vertical 12.5 kg
Stroke: 50 to 300 mm (50 mm Increments)



Overview, Product Series

Electric Linear Slides

Q⁺STEP AZ/AR EAS

Q⁺STEP AZ/AR EZS

Electric Cylinders

Q⁺STEP AZ/AR EAC

Compact Linear Actuators

Q⁺STEP AZ DRS2

DRLII

Installation

Hollow Rotary Actuators

Q⁺STEP AZ/AR DGII

Accessories

Electric Cylinder Specifications

Drive Method	Ball Screw	Repetitive Positioning Accuracy [mm]	±0.02	Min. Traveling Amount [mm]	0.01		
Product Name	Lead Screw Pitch [mm]	Transportable Mass [kg]*		Thrust [N]	Push Force [N]	Holding Force [N]	Maximum Speed [mm/s]
		Horizontal	Vertical				
EAC4R-D ⑤-AZAC ⑨-⑩	12	~15	-	~70	100	70	600
EAC4R-D ⑤-AZMC ⑨-⑩			~7				
EAC4R-E ⑤-AZAC ⑨-⑩	6	~30	-	~125	200	125	300
EAC4R-E ⑤-AZMC ⑨-⑩			~12.5				

*The transportable mass specifications apply when using external linear guide.

● A symbol or number is specified where ⑤ ⑨ ⑩ are located in the product name. For details, please refer to "◇Product Number" on page E-134.

● For details on how to read the specification table, please refer to "How to Read Specifications" on page E-133.

Note

● Do not apply a radial load or load moment to an electric linear cylinder rod. A simple anti-spin mechanism is already provided, but always be sure to provide an external guide.

Positioning Distance – Positioning Time

Check the positioning time (reference) from the positioning distance.

Refer to page E-175 for the operating speed and acceleration.

● Lead Screw Pitch: 12 mm

◇ Horizontal Direction Installation

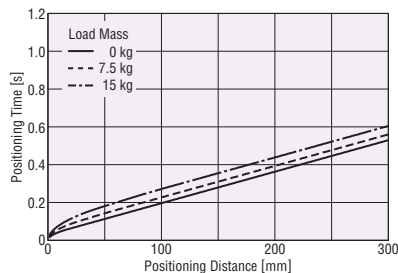

◇ Vertical Direction Installation

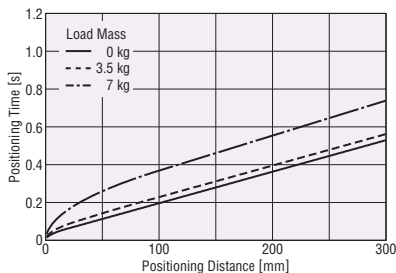

● Lead Screw Pitch: 6 mm

◇ Horizontal Direction Installation

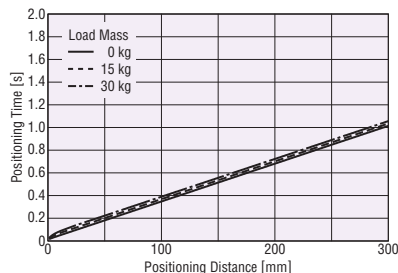

◇ Vertical Direction Installation

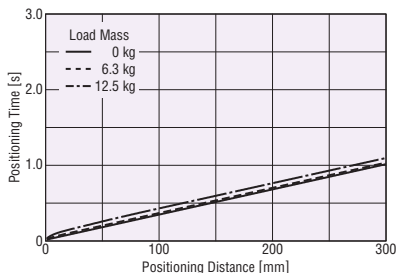

Note

● Starting speed should be 6 mm/s max.

Operating Speed – Thrust

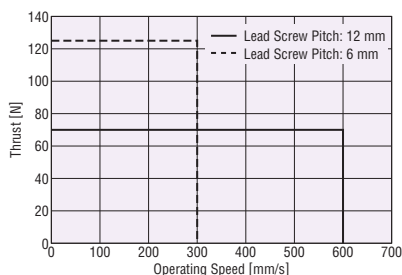

Dimensions

● Electric Cylinder → Page E-163

● Driver → Page E-170

Connection and Operation

● Built-in Controller Type → Page A-60

● Pulse Input Type → Page A-64

EAC4: Frame Size 42 mm × 42 mm 24 VDC Input Straight Type

α STEP
AZ
Equipped

Maximum Transportable Mass: Horizontal 30 kg/Vertical 14 kg

α STEP
AR
Equipped

Stroke: 50 to 300 mm (50 mm Increments)



Electric Cylinder Specifications

Drive Method	Ball Screw	Repetitive Positioning Accuracy [mm]	±0.02	Min. Traveling Amount [mm]	0.01		
Product Name	Lead Screw Pitch [mm]	Transportable Mass [kg]*		Thrust [N]	Push Force [N]	Holding Force [N]	Maximum Speed [mm/s]
		Horizontal	Vertical				
EAC4-D-⑤-AZAK-⑨-⑩	12	~15	—	~70	100	70	600
EAC4-D-⑤-AZMK-⑨-⑩			~7				
EAC4-E-⑤-AZAK-⑨-⑩	6	~30	—	~140	200	140	300
EAC4-E-⑤-AZMK-⑨-⑩			~14				

*The transportable mass specifications apply when using external linear guide.

● A symbol or number is specified where ⑤⑨⑩ are located in the product name. For details, please refer to "◇Product Number" on page E-136.

● For details on how to read the specification table, please refer to "How to Read Specifications" on page E-133.

● For the specification and characteristics of 48 VDC input, please contact the nearest Oriental Motor sales office.

Note

● Do not apply a radial load or load moment to an electric linear cylinder rod. A simple anti-spin mechanism is already provided, but always be sure to provide an external guide.

● The maximum speed may be lowered according to the ambient temperature and the length of the motor cable.

Positioning Distance – Positioning Time

Check the positioning time (reference) from the positioning distance.

Refer to page E-176 for the operating speed and acceleration.

● **Lead Screw Pitch: 12 mm**

◇ **Horizontal Direction Installation**

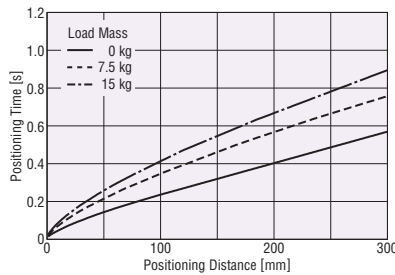

◇ **Vertical Direction Installation**

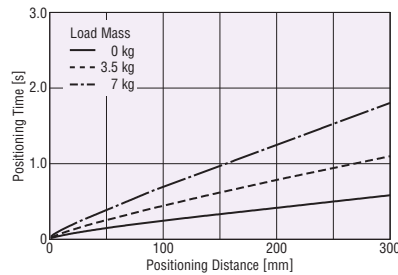

● **Lead Screw Pitch: 6 mm**

◇ **Horizontal Direction Installation**

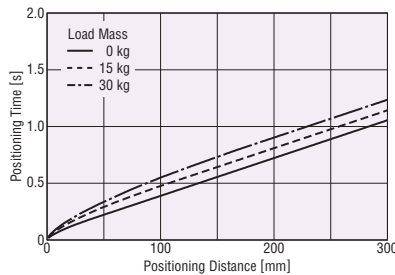

◇ **Vertical Direction Installation**

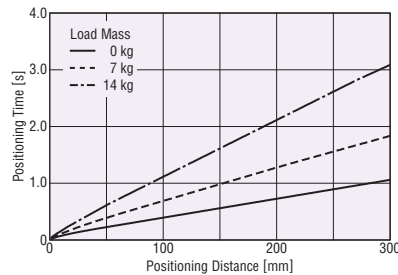

Note

● Starting speed should be 6 mm/s max.

Operating Speed – Thrust

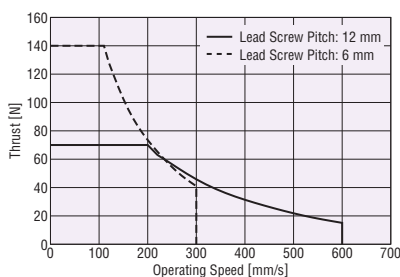

Dimensions

● Electric Cylinder → Page E-162

● Driver → Page E-170

Connection and Operation

● Built-in Controller Type → Page A-205

● Pulse Input Type → Page A-209

EAC4R: Frame Size 42 mm × 42 mm 24 VDC Input Reversed Motor Type

Maximum Transportable Mass: Horizontal 30 kg/Vertical 12.5 kg

Stroke: 50 to 300 mm (50 mm Increments)



Overview, Product Series

Electric Linear Slides

Q⁺STEP AZ/AR EAS

Q⁺STEP AZ/AR EZS

Electric Cylinders

Q⁺STEP AZ/AR EAC

Compact Linear Actuators

Q⁺STEP AZ DRS2

DRLII

Installation

Hollow Rotary Actuators

Q⁺STEP AZ/AR DGII

Accessories

Electric Cylinder Specifications

Drive Method	Ball Screw	Repetitive Positioning Accuracy [mm]	±0.02	Min. Traveling Amount [mm]	0.01		
Product Name	Lead Screw Pitch [mm]	Transportable Mass [kg]*		Thrust [N]	Push Force [N]	Holding Force [N]	Maximum Speed [mm/s]
		Horizontal	Vertical				
EAC4R-D ^⑤ -AZAK ^{⑨-⑩}	12	~15	—	~70	100	70	600
EAC4R-D ^⑤ -AZMK ^{⑨-⑩}			~7				
EAC4R-E ^⑤ -AZAK ^{⑨-⑩}	6	~30	—	~125	200	125	300
EAC4R-E ^⑤ -AZMK ^{⑨-⑩}			~12.5				

*The transportable mass specifications apply when using external linear guide.

● A symbol or number is specified where ⑤⑨⑩ are located in the product name. For details, please refer to "◇Product Number" on page E-136.

● For details on how to read the specification table, please refer to "How to Read Specifications" on page E-133.

● For the specification and characteristics of 48 VDC input, please contact the nearest Oriental Motor sales office.

Note

● Do not apply a radial load or load moment to an electric linear cylinder rod. A simple anti-spin mechanism is already provided, but always be sure to provide an external guide.

● The maximum speed may be lowered according to the ambient temperature and the length of the motor cable.

Positioning Distance – Positioning Time

Check the positioning time (reference) from the positioning distance.

Refer to page E-177 for the operating speed and acceleration.

● Lead Screw Pitch: 12 mm

◇ Horizontal Direction Installation

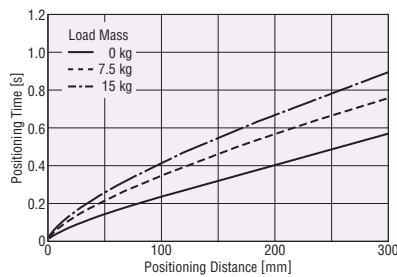

◇ Vertical Direction Installation

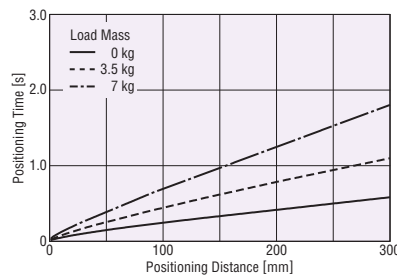

● Lead Screw Pitch: 6 mm

◇ Horizontal Direction Installation

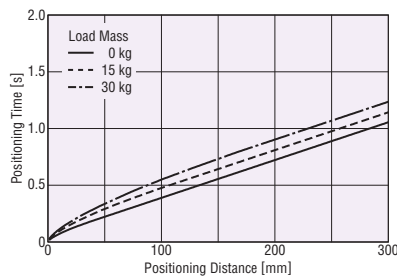

◇ Vertical Direction Installation

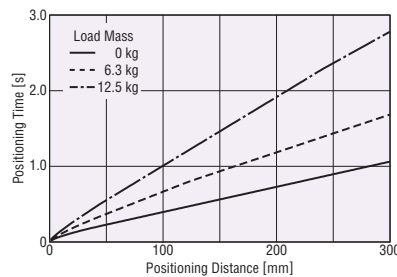

Note

● Starting speed should be 6 mm/s max.

Operating Speed – Thrust

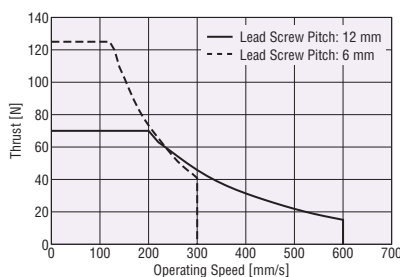

Dimensions

● Electric Cylinder → Page E-163

● Driver → Page E-170

Connection and Operation

● Built-in Controller Type → Page A-205

● Pulse Input Type → Page A-209

EAC6: Frame Size 60 mm × 60 mm AC Input Straight Type

α STEP
AZ
Equipped

α STEP
AR
Equipped

Maximum Transportable Mass: Horizontal 60 kg/Vertical 30 kg

Stroke: 50 to 300 mm (50 mm Increments)



Electric Cylinder Specifications

Drive Method	Ball Screw	Repetitive Positioning Accuracy [mm]	±0.02	Min. Traveling Amount [mm]	0.01		
Product Name	Lead Screw Pitch [mm]	Transportable Mass [kg]*		Thrust [N]	Push Force [N]	Holding Force [N]	Maximum Speed [mm/s]
		Horizontal	Vertical				
EAC6-D ^⑤ -AZAC ^{⑨-⑩}	12	~30	—	~200	400	200	600
EAC6-D ^⑤ -AZMC ^{⑨-⑩}			~15				
EAC6-E ^⑤ -AZAC ^{⑨-⑩}	6	~60	—	~400	500	400	300
EAC6-E ^⑤ -AZMC ^{⑨-⑩}			~30				

*The transportable mass specifications apply when using external linear guide.

● A symbol or number is specified where ⑤⑨⑩ are located in the product name. For details, please refer to "◇Product Number" on page E-134.

● For details on how to read the specification table, please refer to "How to Read Specifications" on page E-133.

Note

● Do not apply a radial load or load moment to an electric linear cylinder rod. A simple anti-spin mechanism is already provided, but always be sure to provide an external guide.

Positioning Distance – Positioning Time

Check the positioning time (reference) from the positioning distance.

Refer to page E-178 for the operating speed and acceleration.

● Lead Screw Pitch: 12 mm

◇ Horizontal Direction Installation

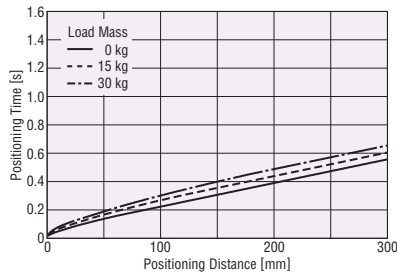

◇ Vertical Direction Installation

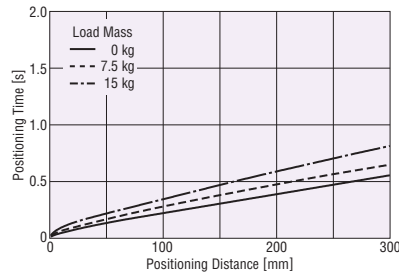

● Lead Screw Pitch: 6 mm

◇ Horizontal Direction Installation

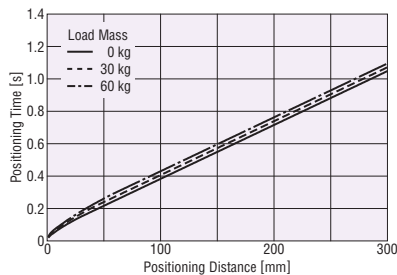

◇ Vertical Direction Installation

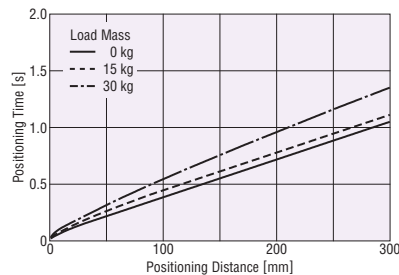

Note

● Starting speed should be 6 mm/s max.

Operating Speed – Thrust

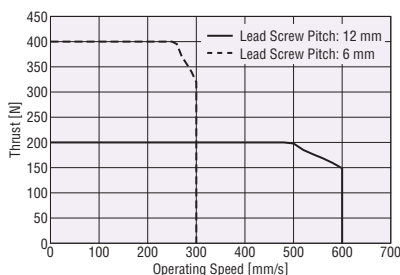

Dimensions

- Electric Cylinder → Page E-164
- Driver → Page E-170

Connection and Operation

- Built-in Controller Type → Page A-60
- Pulse Input Type → Page A-64

EAC6R: Frame Size 60 mm × 60 mm AC Input Reversed Motor Type

Maximum Transportable Mass: Horizontal 60 kg/Vertical 30 kg

Stroke: 50 to 300 mm (50 mm Increments)



Overview, Product Series

Electric Linear Slides

Q⁺STEP AZ/AR EAS

Q⁺STEP AZ/AR EZS

Electric Cylinders

Q⁺STEP AZ/AR EAC

Compact Linear Actuators

Q⁺STEP AZ DRS2

DRLII

Installation

Hollow Rotary Actuators

Q⁺STEP AZ/AR DGII

Accessories

Electric Cylinder Specifications

Drive Method	Ball Screw	Repetitive Positioning Accuracy [mm]	±0.02	Min. Traveling Amount [mm]	0.01		
Product Name	Lead Screw Pitch [mm]	Transportable Mass [kg]*		Thrust [N]	Push Force [N]	Holding Force [N]	Maximum Speed [mm/s]
		Horizontal	Vertical				
EAC6R-D ^⑤ -AZAC ^{⑨-⑩}	12	~30	—	~200	400	200	600
EAC6R-D ^⑤ -AZMC ^{⑨-⑩}			~15				
EAC6R-E ^⑤ -AZAC ^{⑨-⑩}	6	~60	—	~360	500	360	300
EAC6R-E ^⑤ -AZMC ^{⑨-⑩}			~30				

*The transportable mass specifications apply when using external linear guide.

● A symbol or number is specified where ⑤⑨⑩ are located in the product name. For details, please refer to "◇Product Number" on page E-134.

● For details on how to read the specification table, please refer to "How to Read Specifications" on page E-133.

Note

● Do not apply a radial load or load moment to an electric linear cylinder rod. A simple anti-spin mechanism is already provided, but always be sure to provide an external guide.

Positioning Distance – Positioning Time

Check the positioning time (reference) from the positioning distance.

Refer to page E-178 for the operating speed and acceleration.

● Lead Screw Pitch: 12 mm

◇ Horizontal Direction Installation

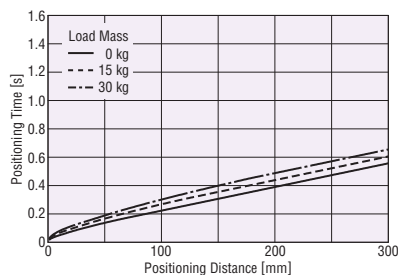

◇ Vertical Direction Installation

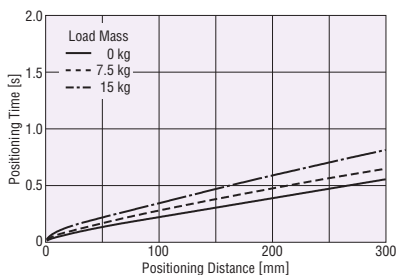

● Lead Screw Pitch: 6 mm

◇ Horizontal Direction Installation

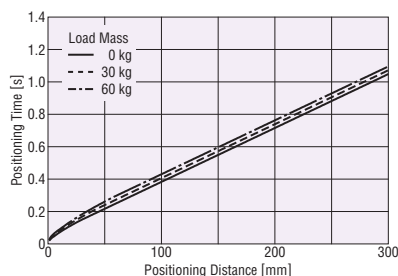

◇ Vertical Direction Installation

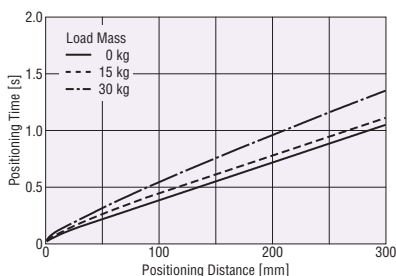

Note

● Starting speed should be 6 mm/s max.

Operating Speed – Thrust

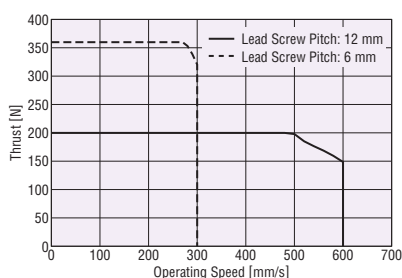

Dimensions

● Electric Cylinder → Page E-165

● Driver → Page E-170

Connection and Operation

● Built-in Controller Type → Page A-60

● Pulse Input Type → Page A-64

EAC6: Frame Size 60 mm × 60 mm 24 VDC Input Straight Type

α STEP
AZ
Equipped

Maximum Transportable Mass: Horizontal 60 kg/Vertical 30 kg

Stroke: 50 to 300 mm (50 mm Increments)

α STEP
AR
Equipped



Electric Cylinder Specifications

Drive Method	Ball Screw	Repetitive Positioning Accuracy [mm]	±0.02	Min. Traveling Amount [mm]	0.01		
Product Name	Lead Screw Pitch [mm]	Transportable Mass [kg]*		Thrust [N]	Push Force [N]	Holding Force [N]	Maximum Speed [mm/s]
		Horizontal	Vertical				
EAC6-D ⑤-AZAK ⑨-⑩	12	~30	—	~200	400	200	600
EAC6-D ⑤-AZMK ⑨-⑩			~15				
EAC6-E ⑤-AZAK ⑨-⑩	6	~60	—	~400	500	400	300
EAC6-E ⑤-AZMK ⑨-⑩			~30				

*The transportable mass specifications apply when using external linear guide.

● A symbol or number is specified where ⑤ ⑨ ⑩ are located in the product name. For details, please refer to "◇Product Number" on page E-136.

● For details on how to read the specification table, please refer to "How to Read Specifications" on page E-133.

● For the specification and characteristics of 48 VDC input, please contact the nearest Oriental Motor sales office.

Note

● Do not apply a radial load or load moment to an electric linear cylinder rod. A simple anti-spin mechanism is already provided, but always be sure to provide an external guide.

● The maximum speed may be lowered according to the ambient temperature and the length of the motor cable.

Positioning Distance – Positioning Time

Check the positioning time (reference) from the positioning distance.

Refer to page E-179 for the operating speed and acceleration.

● **Lead Screw Pitch: 12 mm**

◇ **Horizontal Direction Installation**

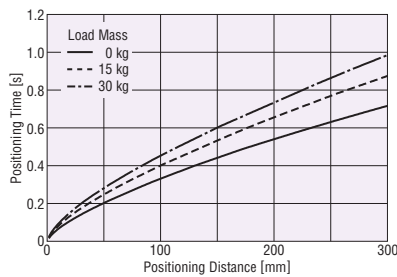

◇ **Vertical Direction Installation**

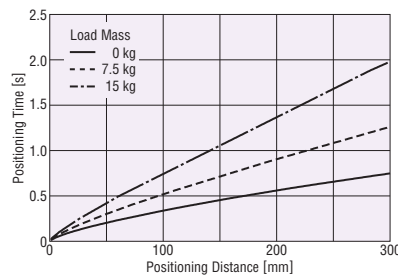

● **Lead Screw Pitch: 6 mm**

◇ **Horizontal Direction Installation**

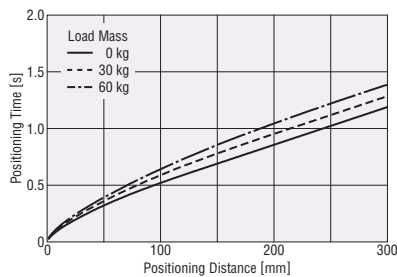

◇ **Vertical Direction Installation**

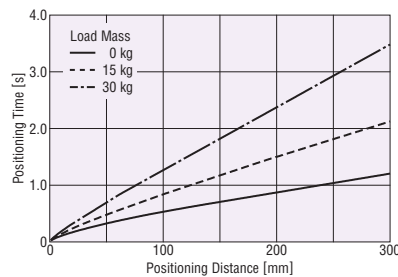

Note

● Starting speed should be 6 mm/s max.

Operating Speed – Thrust

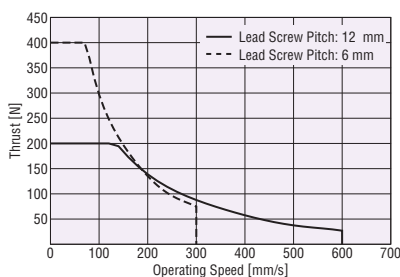

Dimensions

● Electric Cylinder → Page E-164

● Driver → Page E-170

Connection and Operation

● Built-in Controller Type → Page A-205

● Pulse Input Type → Page A-209

EAC6R: Frame Size 60 mm × 60 mm 24 VDC Input Reversed Motor Type

Maximum Transportable Mass: Horizontal 60 kg/Vertical 30 kg

Stroke: 50 to 300 mm (50 mm Increments)



Electric Cylinder Specifications

Drive Method	Ball Screw	Repetitive Positioning Accuracy [mm]	±0.02	Min. Traveling Amount [mm]	0.01		
Product Name	Lead Screw Pitch [mm]	Transportable Mass [kg]*		Thrust [N]	Push Force [N]	Holding Force [N]	Maximum Speed [mm/s]
		Horizontal	Vertical				
EAC6R-D ⑤- AZAK ⑨-⑩	12	~30	—	~200	400	200	600
EAC6R-D ⑤- AZMK ⑨-⑩			~15				
EAC6R-E ⑤- AZAK ⑨-⑩	6	~60	—	~360	500	360	300
EAC6R-E ⑤- AZMK ⑨-⑩			~30				

- *The transportable mass specifications apply when using external linear guide.
- A symbol or number is specified where ⑤⑨⑩ are located in the product name. For details, please refer to "◇Product Number" on page E-136.
- For details on how to read the specification table, please refer to "How to Read Specifications" on page E-133.
- For the specification and characteristics of 48 VDC input, please contact the nearest Oriental Motor sales office.

Note

- Do not apply a radial load or load moment to an electric linear cylinder rod. A simple anti-spin mechanism is already provided, but always be sure to provide an external guide.
- The maximum speed may be lowered according to the ambient temperature and the length of the motor cable.

Positioning Distance – Positioning Time

Check the positioning time (reference) from the positioning distance.
Refer to page E-179 for the operating speed and acceleration.

● Lead Screw Pitch: 12 mm

◇ Horizontal Direction Installation

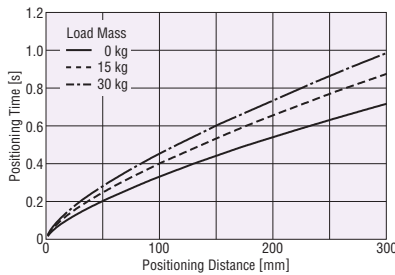

◇ Vertical Direction Installation

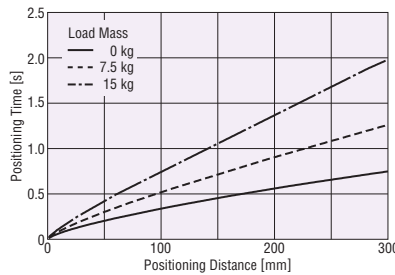

● Lead Screw Pitch: 6 mm

◇ Horizontal Direction Installation

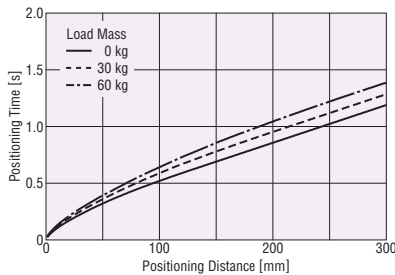

◇ Vertical Direction Installation

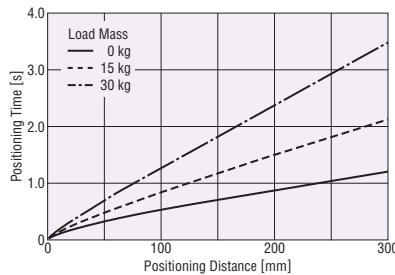

Note

- Starting speed should be 6 mm/s max.

Operating Speed – Thrust

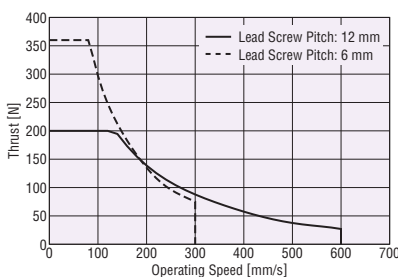

Dimensions

- Electric Cylinder → Page E-165
- Driver → Page E-170

Connection and Operation

- Built-in Controller Type → Page A-205
- Pulse Input Type → Page A-209

Overview, Product Series

Electric Linear Slides

Q⁺STEP AZ/AR EAS

Q⁺STEP AZ/AR EZS

Electric Cylinders

Q⁺STEP AZ/AR EAC

Compact Linear Actuators

Q⁺STEP AZ DRS2

DRLII

Installation

Hollow Rotary Actuators

Q⁺STEP AZ/AR DGII

Accessories

EAC4W: Frame Size 42 mm × 114 mm AC Input Straight Type with Shaft Guide (with Cover)

α STEP
AZ
Equipped

Maximum Transportable Mass: Horizontal 30 kg/Vertical 13 kg

Stroke: 50 to 300 mm (50 mm Increments)

α STEP
AR
Equipped



Electric Cylinder Specifications

Drive Method	Ball Screw	Repetitive Positioning Accuracy [mm]	±0.02	Min. Traveling Amount [mm]	0.01	Dynamic Permissible Moment [N·m]	M _e : 1.3	M _v : 1.3	M _r : 0.6
						Static Permissible Moment [N·m]	M _e : 3.7	M _v : 3.7	M _r : 3.0

Product Name	Lead Screw Pitch [mm]	Transportable Mass [kg]*		Thrust [N]	Push Force [N]	Holding Force [N]	Maximum Speed [mm/s]
		Horizontal	Vertical				
EAC4W-D-5-AZAC(9-10-11)	12	~15	-	~70	100	70	600
EAC4W-D-5-AZMC(9-10-11)			~6				
EAC4W-E-5-AZAC(9-10-11)	6	~30	-	~140	200	140	300
EAC4W-E-5-AZMC(9-10-11)			~13				

*The transportable mass specifications apply when using external linear guide. When the linear guide is not used, refer to "Horizontal Transportable Mass".

● A symbol or number is specified where (9)(10)(11) are located in the product name. For details, please refer to "◇Product Number" on page E-134.

● For details on how to read the specification table, please refer to "How to Read Specifications" on page E-133.

Positioning Distance – Positioning Time

Check the positioning time (reference) from the positioning distance.

Refer to page E-180 for the operating speed and acceleration.

● Lead Screw Pitch: 12 mm

◇ Horizontal Direction Installation

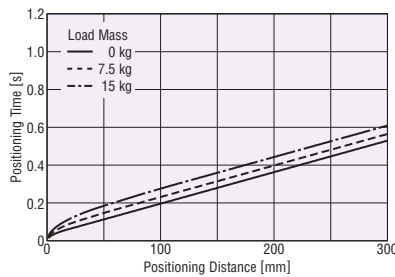

◇ Vertical Direction Installation

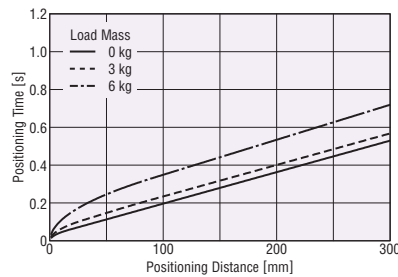

● Lead Screw Pitch: 6 mm

◇ Horizontal Direction Installation

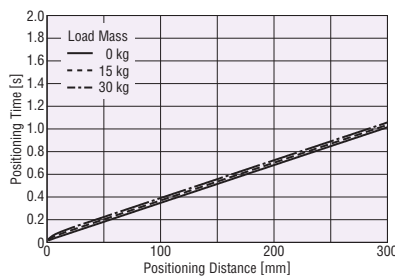

◇ Vertical Direction Installation

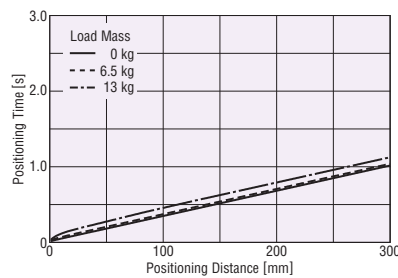

Note

● Starting speed should be 6 mm/s max.

Operating Speed – Thrust

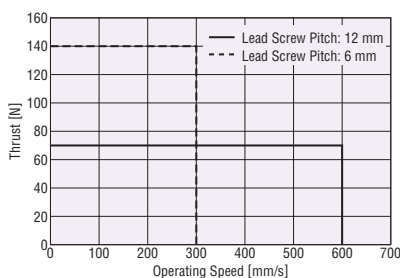

Horizontal Transportable Mass

◇ Positioning Distance – Horizontal Transportable Mass

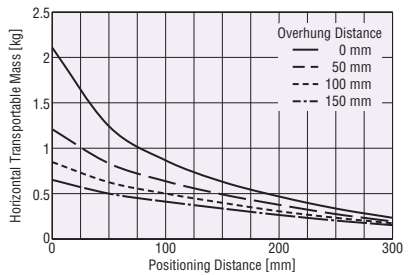

Products equipped with a shaft guide and shaft guide cover can transport loads that are attached directly to the body of the product. Check the horizontal transportable mass in the graph above.

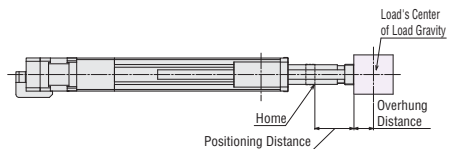

● The positioning distance means the distance from the home position.

● The overhang distance means the distance that the load extends beyond the installation surface.

Dimensions

● Electric Cylinder → Page E-166

● Driver → Page E-170

Connection and Operation

● Built-in Controller Type → Page A-60

● Pulse Input Type → Page A-64

EAC4RW: Frame Size 42 mm × 114 mm AC Input Reversed Motor Type with Shaft Guide (with Cover)

Maximum Transportable Mass: Horizontal 30 kg/Vertical 11.5 kg

Stroke: 50 to 300 mm (50 mm Increments)



Electric Cylinder Specifications

Drive Method	Ball Screw	Repetitive Positioning Accuracy [mm]	±0.02	Min. Traveling Amount [mm]	0.01	Dynamic Permissible Moment [N·m]	M _p : 1.3	M _v : 1.3	M _R : 0.6
						Static Permissible Moment [N·m]	M _s : 3.7	M _v : 3.7	M _R : 3.0

Product Name	Lead Screw Pitch [mm]	Transportable Mass [kg]*		Thrust [N]	Push Force [N]	Holding Force [N]	Maximum Speed [mm/s]
		Horizontal	Vertical				
EAC4RW-D-5-AZAC ^{⑤⑨⑩⑪}	12	~15	—	~70	100	70	600
EAC4RW-D-5-AZMC ^{⑤⑨⑩⑪}			~6				
EAC4RW-E ^⑤ -AZAC ^{⑨⑩⑪}	6	~30	—	~125	200	125	300
EAC4RW-E ^⑤ -AZMC ^{⑨⑩⑪}			~11.5				

*The transportable mass specifications apply when using external linear guide. When the linear guide is not used, refer to "Horizontal Transportable Mass".

● A symbol or number is specified where ⑤⑨⑩⑪ are located in the product name. For details, please refer to "◇Product Number" on page E-134.

● For details on how to read the specification table, please refer to "How to Read Specifications" on page E-133.

Positioning Distance – Positioning Time

Check the positioning time (reference) from the positioning distance.

Refer to page E-181 for the operating speed and acceleration.

● Lead Screw Pitch: 12 mm

◇ Horizontal Direction Installation

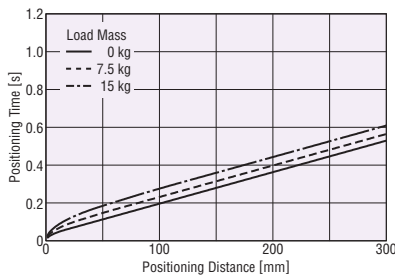

◇ Vertical Direction Installation

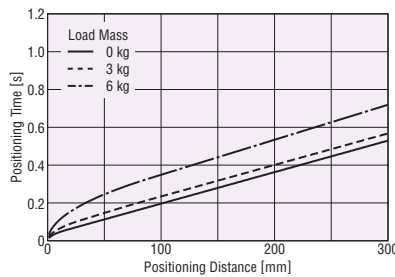

● Lead Screw Pitch: 6 mm

◇ Horizontal Direction Installation

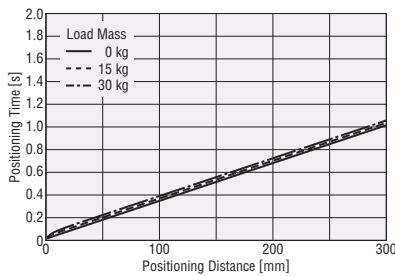

◇ Vertical Direction Installation

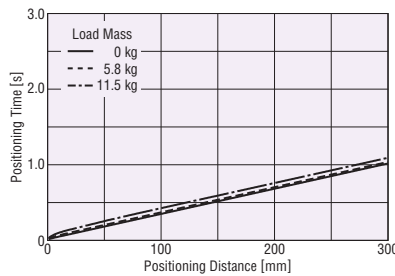

Note

● Starting speed should be 6 mm/s max.

Operating Speed – Thrust

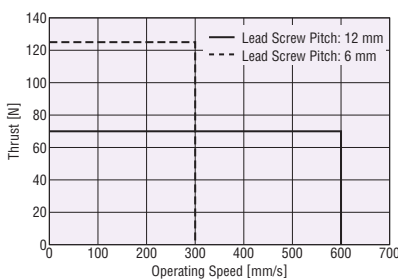

Horizontal Transportable Mass

◇ Positioning Distance – Horizontal Transportable Mass

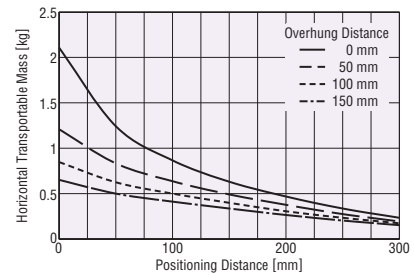

Products equipped with a shaft guide and shaft guide cover can transport loads that are attached directly to the body of the product. Check the horizontal transportable mass in the graph above.

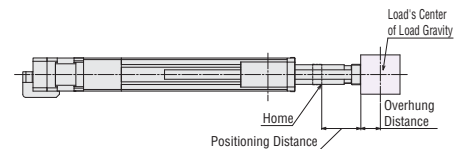

- The positioning distance means the distance from the home position.
- The overhung distance means the distance that the load extends beyond the installation surface.

Dimensions

● Electric Cylinder → Page E-167

● Driver → Page E-170

Connection and Operation

● Built-in Controller Type → Page A-60

● Pulse Input Type → Page A-64

Overview, Product Series

Electric Linear Slides

Q/STEP AZ/AR EAS

Q/STEP AZ/AR EZS

Electric Cylinders

Q/STEP AZ/AR EAC

Compact Linear Actuators

Q/STEP AZ DRS2

DRLII

Installation

Hollow Rotary Actuators

Q/STEP AZ/AR DGII

Accessories

EAC4W: Frame Size 42 mm × 114 mm 24 VDC Input Straight Type with Shaft Guide (with Cover)

α STEP
AZ
Equipped

Maximum Transportable Mass: Horizontal 30 kg/Vertical 13 kg

Stroke: 50 to 300 mm (50 mm Increments)

α STEP
AR
Equipped



Electric Cylinder Specifications

Drive Method	Ball Screw	Repetitive Positioning Accuracy [mm]	±0.02	Min. Traveling Amount [mm]	0.01	Dynamic Permissible Moment [N·m]	M _e : 1.3	M _v : 1.3	M _r : 0.6
						Static Permissible Moment [N·m]	M _e : 3.7	M _v : 3.7	M _r : 3.0

Product Name	Lead Screw Pitch [mm]	Transportable Mass [kg]*		Thrust [N]	Push Force [N]	Holding Force [N]	Maximum Speed [mm/s]
		Horizontal	Vertical				
EAC4W-D-5-AZAK(9-10-11)	12	~15	—	~70	100	70	600
EAC4W-D-5-AZMK(9-10-11)			~6				
EAC4W-E-5-AZAK(9-10-11)	6	~30	—	~140	200	140	300
EAC4W-E-5-AZMK(9-10-11)			~13				

*The transportable mass specifications apply when using external linear guide. When the linear guide is not used, refer to "Horizontal Transportable Mass".

● A symbol or number is specified where (9)(10)(11) are located in the product name. For details, please refer to "◇Product Number" on page E-136.

● For details on how to read the specification table, please refer to "How to Read Specifications" on page E-133.

● For the specification and characteristics of 48 VDC input, please contact the nearest Oriental Motor sales office.

Note

● The maximum speed may be lowered according to the ambient temperature and the length of the motor cable.

Positioning Distance – Positioning Time

Check the positioning time (reference) from the positioning distance.

Refer to page E-182 for the operating speed and acceleration.

● Lead Screw Pitch: 12 mm

◇ Horizontal Direction Installation

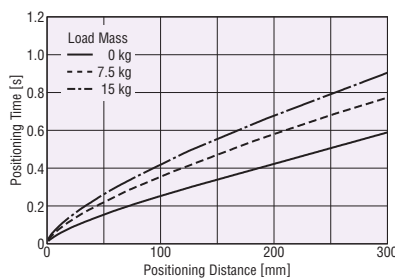

◇ Vertical Direction Installation

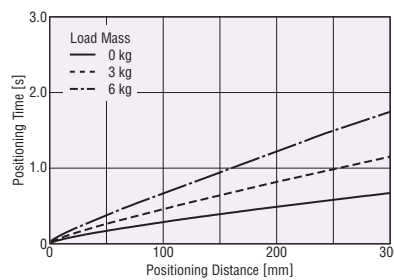

● Lead Screw Pitch: 6 mm

◇ Horizontal Direction Installation

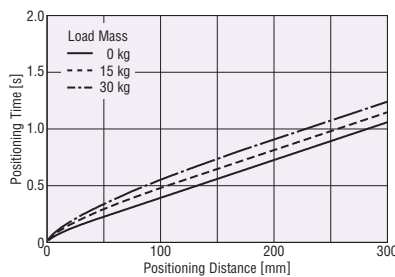

◇ Vertical Direction Installation



Note

● Starting speed should be 6 mm/s max.

Operating Speed – Thrust

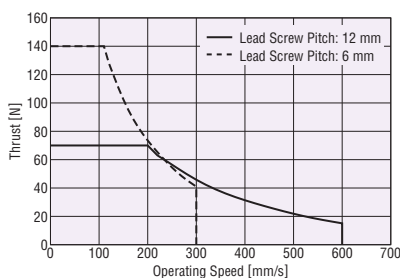

Horizontal Transportable Mass

◇ Positioning Distance – Horizontal Transportable Mass

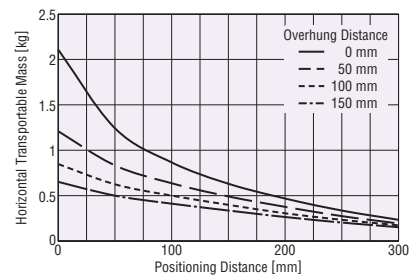

Products equipped with a shaft guide and shaft guide cover can transport loads that are attached directly to the body of the product. Check the horizontal transportable mass in the graph above.

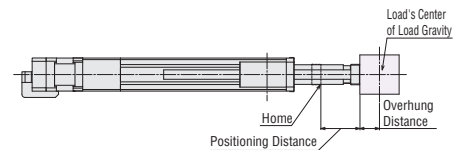

- The positioning distance means the distance from the home position.
- The overhung distance means the distance that the load extends beyond the installation surface.

Dimensions

- Electric Cylinder → Page E-166
- Driver → Page E-170

Connection and Operation

- Built-in Controller Type → Page A-205
- Pulse Input Type → Page A-209

EAC4RW: Frame Size 42 mm × 114 mm 24 VDC Input Reversed Motor Type with Shaft Guide (with Cover)

Maximum Transportable Mass: Horizontal 30 kg/Vertical 11.5 kg

Stroke: 50 to 300 mm (50 mm Increments)



Electric Cylinder Specifications

Drive Method	Ball Screw	Repetitive Positioning Accuracy [mm]	±0.02	Min. Traveling Amount [mm]	0.01	Dynamic Permissible Moment [N·m]	M _p : 1.3	M _v : 1.3	M _r : 0.6
						Static Permissible Moment [N·m]	M _p : 3.7	M _v : 3.7	M _r : 3.0

Product Name	Lead Screw Pitch [mm]	Transportable Mass [kg]*		Thrust [N]	Push Force [N]	Holding Force [N]	Maximum Speed [mm/s]
		Horizontal	Vertical				
EAC4RW-D ^⑤ -AZAK ^{⑨-⑩-⑪}	12	~15	-	~70	100	70	600
EAC4RW-D ^⑤ -AZMK ^{⑨-⑩-⑪}			~6				
EAC4RW-E ^⑤ -AZAK ^{⑨-⑩-⑪}	6	~30	-	~125	200	125	300
EAC4RW-E ^⑤ -AZMK ^{⑨-⑩-⑪}			~11.5				

*The transportable mass specifications apply when using external linear guide. When the linear guide is not used, refer to "Horizontal Transportable Mass".

- A symbol or number is specified where ⑤⑨⑩⑪ are located in the product name. For details, please refer to "◇Product Number" on page E-136.
- For details on how to read the specification table, please refer to "How to Read Specifications" on page E-133.
- For the specification and characteristics of 48 VDC input, please contact the nearest Oriental Motor sales office.

Note

- The maximum speed may be lowered according to the ambient temperature and the length of the motor cable.

Positioning Distance – Positioning Time

Check the positioning time (reference) from the positioning distance. Refer to page E-183 for the operating speed and acceleration.

● Lead Screw Pitch: 12 mm

◇ Horizontal Direction Installation

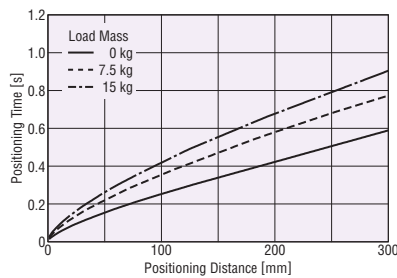

◇ Vertical Direction Installation

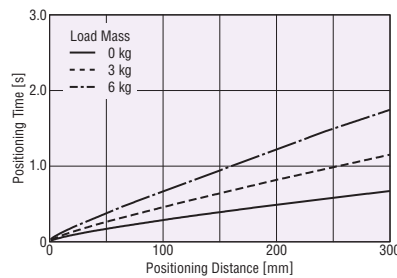

● Lead Screw Pitch: 6 mm

◇ Horizontal Direction Installation

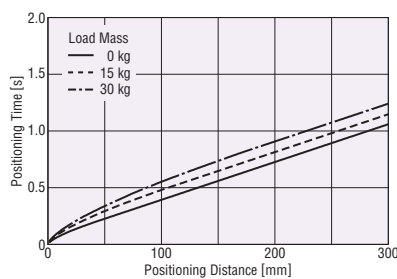

◇ Vertical Direction Installation

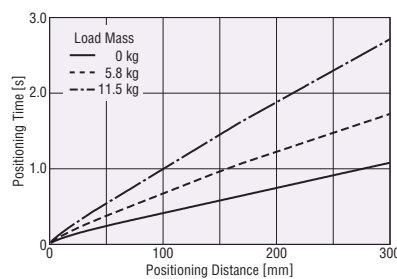

Note

- Starting speed should be 6 mm/s max.

Operating Speed – Thrust

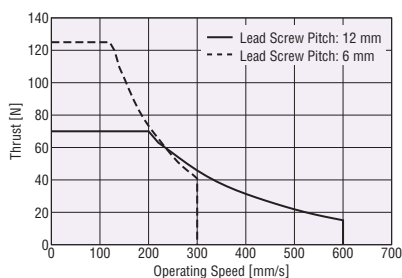

Horizontal Transportable Mass

◇ Positioning Distance – Horizontal Transportable Mass

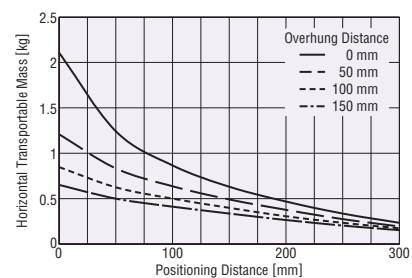

Products equipped with a shaft guide and shaft guide cover can transport loads that are attached directly to the body of the product. Check the horizontal transportable mass in the graph above.

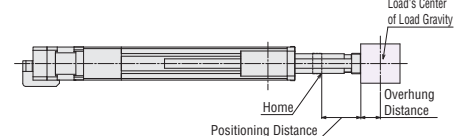

- The positioning distance means the distance from the home position.
- The overhang distance means the distance that the load extends beyond the installation surface.

Dimensions

- Electric Cylinder → Page E-167
- Driver → Page E-170

Connection and Operation

- Built-in Controller Type → Page A-205
- Pulse Input Type → Page A-209

Overview, Product Series

Electric Linear Slides

Q⁺STEP AZ/AR EAS

Q⁺STEP AZ/AR EZS

Electric Cylinders

Q⁺STEP AZ/AR EAC

Compact Linear Actuators

Q⁺STEP AZ DRS2

DRLII

Installation

Hollow Rotary Actuators

Q⁺STEP AZ/AR DGII

Accessories

EAC6W: Frame Size 60 mm × 156 mm AC Input Straight Type with Shaft Guide (with Cover)

α STEP
AZ
Equipped

Maximum Transportable Mass: Horizontal 60 kg/Vertical 28 kg

α STEP
AR
Equipped

Stroke: 50 to 300 mm (50 mm Increments)



Electric Cylinder Specifications

Drive Method	Ball Screw	Repetitive Positioning Accuracy [mm]	±0.02	Min. Traveling Amount [mm]	0.01	Dynamic Permissible Moment [N·m]	M _p : 2.2	M _v : 2.2	M _r : 1.3
						Static Permissible Moment [N·m]	M _p : 7.8	M _v : 7.8	M _r : 3.0

Product Name	Lead Screw Pitch [mm]	Transportable Mass [kg]*		Thrust [N]	Push Force [N]	Holding Force [N]	Maximum Speed [mm/s]
		Horizontal	Vertical				
EAC6W-D-5-AZAC ^{⑤⑨⑩⑪}	12	~30	—	~200	400	200	600
EAC6W-D-5-AZMC ^{⑤⑨⑩⑪}			~13				
EAC6W-E-5-AZAC ^{⑤⑨⑩⑪}	6	~60	—	~400	500	400	300
EAC6W-E-5-AZMC ^{⑤⑨⑩⑪}			~28				

*The transportable mass specifications apply when using external linear guide. When the linear guide is not used, refer to "Horizontal Transportable Mass".

● A symbol or number is specified where ⑤⑨⑩⑪ are located in the product name. For details, please refer to "◇Product Number" on page E-134.

● For details on how to read the specification table, please refer to "How to Read Specifications" on page E-133.

Positioning Distance – Positioning Time

Check the positioning time (reference) from the positioning distance.
Refer to page E-184 for the operating speed and acceleration.

● Lead Screw Pitch: 12 mm

◇ Horizontal Direction Installation

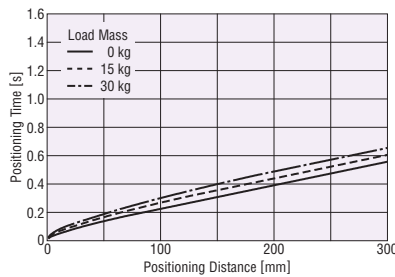

◇ Vertical Direction Installation

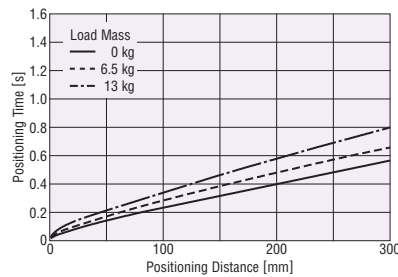

● Lead Screw Pitch: 6 mm

◇ Horizontal Direction Installation

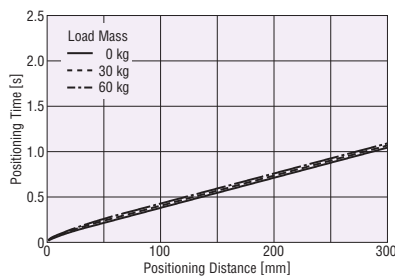

◇ Vertical Direction Installation

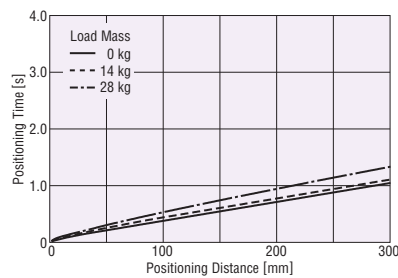

Note

● Starting speed should be 6 mm/s max.

Operating Speed – Thrust

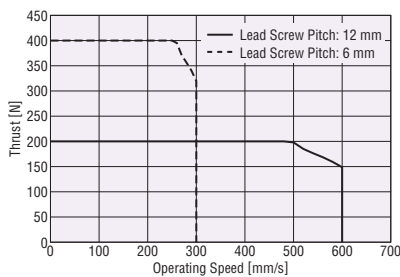

Horizontal Transportable Mass

◇ Positioning Distance – Horizontal Transportable Mass

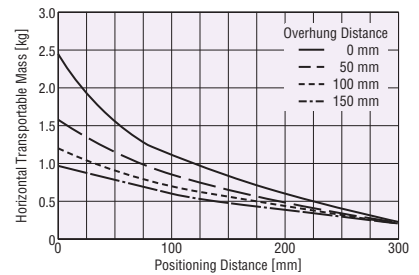

Products equipped with a shaft guide and shaft guide cover can transport loads that are attached directly to the body of the product. Check the horizontal transportable mass in the graph above.

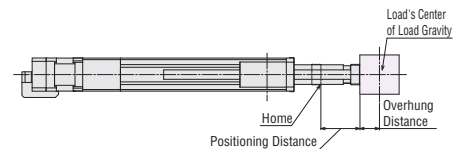

- The positioning distance means the distance from the home position.
- The overhang distance means the distance that the load extends beyond the installation surface.

Dimensions

- Electric Cylinder → Page E-168
- Driver → Page E-170

Connection and Operation

- Built-in Controller Type → Page A-60
- Pulse Input Type → Page A-64

EAC6RW: Frame Size 60 mm × 156 mm AC Input Reversed Motor Type with Shaft Guide (with Cover)

Maximum Transportable Mass: Horizontal 60 kg/Vertical 28 kg

Stroke: 50 to 300 mm (50 mm Increments)



Electric Cylinder Specifications

Drive Method	Ball Screw	Repetitive Positioning Accuracy [mm]	±0.02	Min. Traveling Amount [mm]	0.01	Dynamic Permissible Moment [N·m]	M _p : 2.2	M _v : 2.2	M _r : 1.3
						Static Permissible Moment [N·m]	M _p : 7.8	M _v : 7.8	M _r : 3.0

Product Name	Lead Screw Pitch [mm]	Transportable Mass [kg]*		Thrust [N]	Push Force [N]	Holding Force [N]	Maximum Speed [mm/s]
		Horizontal	Vertical				
EAC6RW-D-5-AZAC ^{⑤⑨⑩⑪}	12	~30	-	~200	400	200	600
EAC6RW-D-5-AZMC ^{⑤⑨⑩⑪}			~13				
EAC6RW-E ^⑤ -AZAC ^{⑤⑨⑩⑪}	6	~60	-	~360	500	360	300
EAC6RW-E ^⑤ -AZMC ^{⑤⑨⑩⑪}			~28				

*The transportable mass specifications apply when using external linear guide. When the linear guide is not used, refer to "Horizontal Transportable Mass".

● A symbol or number is specified where ⑤⑨⑩⑪ are located in the product name. For details, please refer to "◇Product Number" on page E-134.

● For details on how to read the specification table, please refer to "How to Read Specifications" on page E-133.

Positioning Distance – Positioning Time

Check the positioning time (reference) from the positioning distance.

Refer to page E-184 for the operating speed and acceleration.

● Lead Screw Pitch: 12 mm

◇ Horizontal Direction Installation

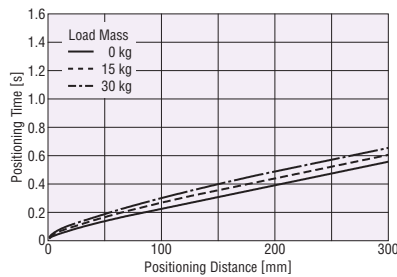

◇ Vertical Direction Installation

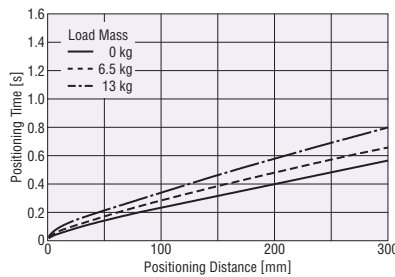

● Lead Screw Pitch: 6 mm

◇ Horizontal Direction Installation

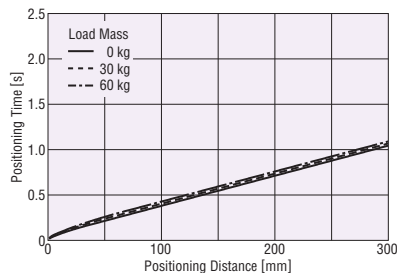

◇ Vertical Direction Installation

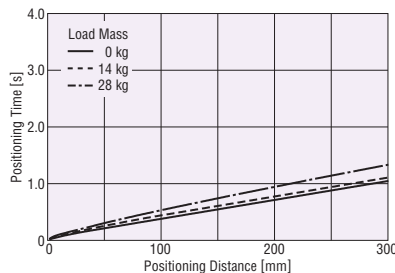

Note

● Starting speed should be 6 mm/s max.

Operating Speed – Thrust

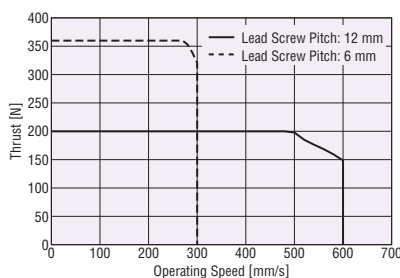

Horizontal Transportable Mass

◇ Positioning Distance – Horizontal Transportable Mass

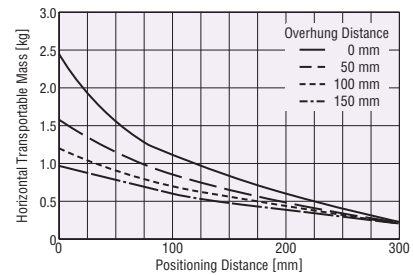

Products equipped with a shaft guide and shaft guide cover can transport loads that are attached directly to the body of the product. Check the horizontal transportable mass in the graph above.

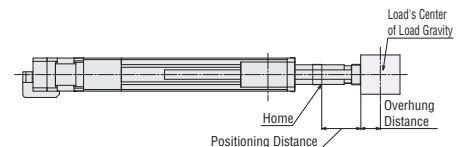

- The positioning distance means the distance from the home position.
- The overhang distance means the distance that the load extends beyond the installation surface.

Dimensions

● Electric Cylinder → Page E-169

● Driver → Page E-170

Connection and Operation

● Built-in Controller Type → Page A-60

● Pulse Input Type → Page A-64

Overview, Product Series

Electric Linear Slides

Q⁺STEP AZ/AR EAS

Q⁺STEP AZ/AR EZS

Electric Cylinders

Q⁺STEP AZ/AR EAC

Compact Linear Actuators

Q⁺STEP AZ DRS2

DRLII

Installation

Hollow Rotary Actuators

Q⁺STEP AZ/AR DGII

Accessories

EAC6W: Frame Size 60 mm × 156 mm 24 VDC Input Straight Type with Shaft Guide (with Cover)

α STEP
AZ
Equipped

Maximum Transportable Mass: Horizontal 60 kg/Vertical 28 kg

α STEP
AR
Equipped

Stroke: 50 to 300 mm (50 mm Increments)



Electric Cylinder Specifications

Drive Method	Ball Screw	Repetitive Positioning Accuracy [mm]	±0.02	Min. Traveling Amount [mm]	0.01	Dynamic Permissible Moment [N·m]	M _e : 2.2	M _v : 2.2	M _r : 1.3
						Static Permissible Moment [N·m]	M _e : 7.8	M _v : 7.8	M _r : 3.0

Product Name	Lead Screw Pitch [mm]	Transportable Mass [kg]*		Thrust [N]	Push Force [N]	Holding Force [N]	Maximum Speed [mm/s]
		Horizontal	Vertical				
EAC6W-D-5-AZAK ^{⑨-⑩-⑪}	12	~30	-	~200	400	200	600
EAC6W-D-5-AZMK ^{⑨-⑩-⑪}			~13				
EAC6W-E-5-AZAK ^{⑨-⑩-⑪}	6	~60	-	~400	500	400	300
EAC6W-E-5-AZMK ^{⑨-⑩-⑪}			~28				

*The transportable mass specifications apply when using external linear guide. When the linear guide is not used, refer to "Horizontal Transportable Mass".

● A symbol or number is specified where ^⑨^⑩^⑪ are located in the product name. For details, please refer to "◇Product Number" on page E-136.

● For details on how to read the specification table, please refer to "How to Read Specifications" on page E-133.

● For the specification and characteristics of 48 VDC input, please contact the nearest Oriental Motor sales office.

Note

● The maximum speed may be lowered according to the ambient temperature and the length of the motor cable.

Positioning Distance – Positioning Time

Check the positioning time (reference) from the positioning distance.

Refer to page E-185 for the operating speed and acceleration.

● Lead Screw Pitch: 12 mm

◇ Horizontal Direction Installation

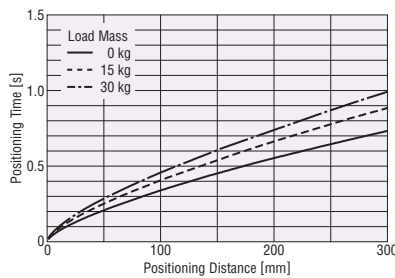

◇ Vertical Direction Installation

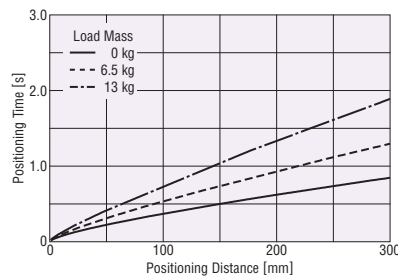

● Lead Screw Pitch: 6 mm

◇ Horizontal Direction Installation

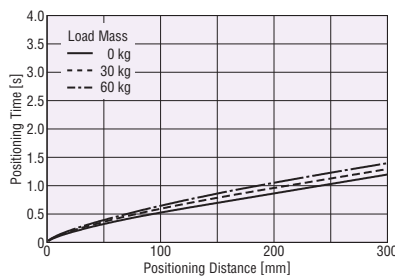

◇ Vertical Direction Installation

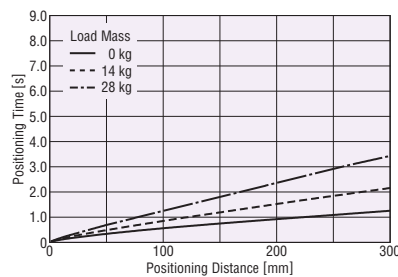

Note

● Starting speed should be 6 mm/s max.

Operating Speed – Thrust

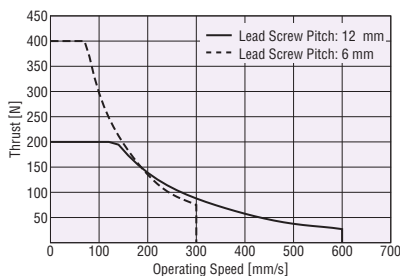

Horizontal Transportable Mass

◇ Positioning Distance – Horizontal Transportable Mass

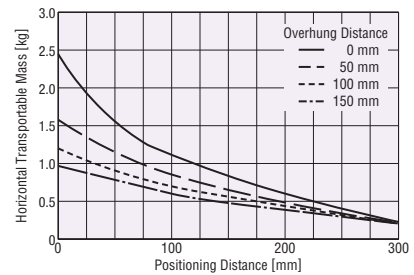

Products equipped with a shaft guide and shaft guide cover can transport loads that are attached directly to the body of the product. Check the horizontal transportable mass in the graph above.

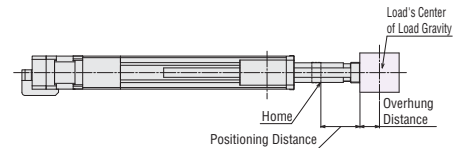

- The positioning distance means the distance from the home position.
- The overhang distance means the distance that the load extends beyond the installation surface.

Dimensions

- Electric Cylinder → Page E-168
- Driver → Page E-170

Connection and Operation

- Built-in Controller Type → Page A-205
- Pulse Input Type → Page A-209

EAC6RW: Frame Size 60 mm × 156 mm 24 VDC Input Reversed Motor Type with Shaft Guide (with Cover)

Maximum Transportable Mass: Horizontal 60 kg/Vertical 28 kg

Stroke: 50 to 300 mm (50 mm Increments)



Electric Cylinder Specifications

Drive Method	Ball Screw	Repetitive Positioning Accuracy [mm]	±0.02	Min. Traveling Amount [mm]	0.01	Dynamic Permissible Moment [N·m]	M _r : 2.2	M _v : 2.2	M _r : 1.3
						Static Permissible Moment [N·m]	M _r : 7.8	M _v : 7.8	M _r : 3.0

Product Name	Lead Screw Pitch [mm]	Transportable Mass [kg]*		Thrust [N]	Push Force [N]	Holding Force [N]	Maximum Speed [mm/s]
		Horizontal	Vertical				
EAC6RW-D ^⑤ -AZAK ^{⑨-⑩-⑪}	12	~30	-	~200	400	200	600
EAC6RW-D ^⑤ -AZMK ^{⑨-⑩-⑪}			~13				
EAC6RW-E ^⑤ -AZAK ^{⑨-⑩-⑪}	6	~60	-	~360	500	360	300
EAC6RW-E ^⑤ -AZMK ^{⑨-⑩-⑪}			~28				

*The transportable mass specifications apply when using external linear guide. When the linear guide is not used, refer to "Horizontal Transportable Mass".

● A symbol or number is specified where ⑤⑨⑩⑪ are located in the product name. For details, please refer to "◇Product Number" on page E-136.

● For details on how to read the specification table, please refer to "How to Read Specifications" on page E-133.

● For the specification and characteristics of 48 VDC input, please contact the nearest Oriental Motor sales office.

Note

● The maximum speed may be lowered according to the ambient temperature and the length of the motor cable.

Positioning Distance – Positioning Time

Check the positioning time (reference) from the positioning distance.

Refer to page E-185 for the operating speed and acceleration.

● Lead Screw Pitch: 12 mm

◇ Horizontal Direction Installation

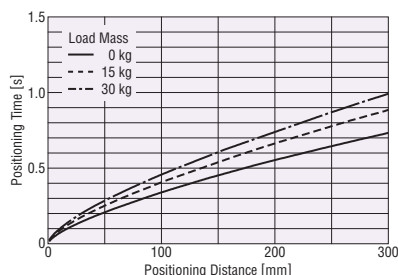

◇ Vertical Direction Installation

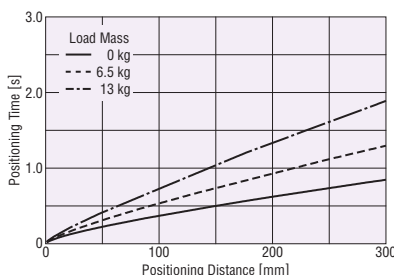

● Lead Screw Pitch: 6 mm

◇ Horizontal Direction Installation

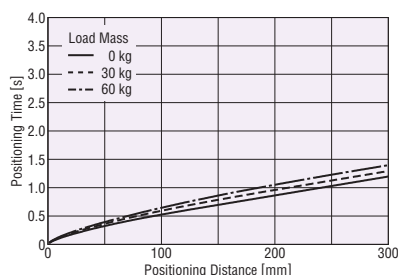

◇ Vertical Direction Installation

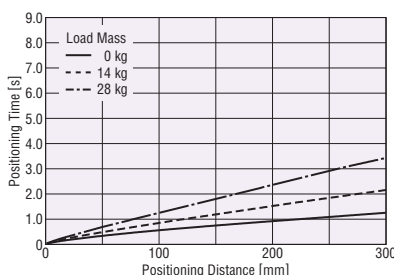

Note

● Starting speed should be 6 mm/s max.

Operating Speed – Thrust

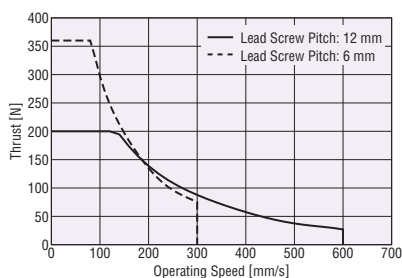

Horizontal Transportable Mass

◇ Positioning Distance – Horizontal Transportable Mass

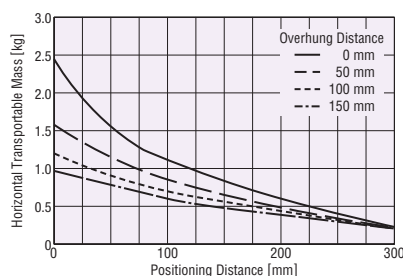

Products equipped with a shaft guide and shaft guide cover can transport loads that are attached directly to the body of the product. Check the horizontal transportable mass in the graph above.

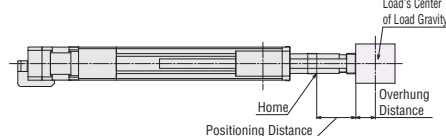

- The positioning distance means the distance from the home position.
- The overhung distance means the distance that the load extends beyond the installation surface.

Dimensions

- Electric Cylinder → Page E-169
- Driver → Page E-170

Connection and Operation

- Built-in Controller Type → Page A-205
- Pulse Input Type → Page A-209

Overview, Product Series

Electric Linear Slides

Q⁺STEP AZ/AR EAS

Q⁺STEP AZ/AR EZS

Electric Cylinders

Q⁺STEP AZ/AR EAC

Compact Linear Actuators

Q⁺STEP AZ DRS2

DRLII

Installation

Hollow Rotary Actuators

Q⁺STEP AZ/AR DGII

Accessories

Motor Specifications (AZ Series)

● General Specifications

AC Input: DC Input:

Item		AC Input	DC Input
Thermal Class		130 (B) [The AC input is certified as compliant with UL 105 (A).]	
Insulation Resistance		100 M Ω or more when a 500 VDC megger is applied between the following places: • Case – Motor Windings • Case – Electromagnetic Brake Windings*1	
Dielectric Strength		Sufficient to withstand the following for 1 minute: EAC4, EAC6 • Case – Motor Windings 1.5 kVAC, 50 Hz or 60 Hz • Case – Electromagnetic Brake Windings*1 1.5 kVAC, 50 Hz or 60 Hz	Sufficient to withstand the following for 1 minute: EAC2 • Case – Motor Windings 0.5 kVAC, 50 Hz or 60 Hz EAC4, EAC6 • Case – Motor Windings 1.0 kVAC, 50 Hz or 60 Hz • Case – Electromagnetic Brake Windings*1 1.0 kVAC, 50 Hz or 60 Hz
Operating Environment (In operation)	Ambient Temperature	0 ~ +40°C (Non-freezing)	
	Ambient Humidity	85% or less (Non-condensing)	
	Atmosphere	No corrosive gases or dust. The product should not be exposed to water, oil or other liquids.	
Degree of Protection*2		EAC2: IP40 (excluding installation surfaces and connector locations) EAC4, EAC6: IP66 (excluding installation surfaces and connector locations)	
Multiple Rotation Detection Range in Power OFF State		EAC2: \pm 450 Rotation (900 Rotations) EAC4, EAC6: \pm 900 Rotations (1800 Rotations)	

*1 Only for products with an electromagnetic brake.

*2 Only for motor parts.

Note

- Do not measure insulation resistance or perform a dielectric strength test while the electric cylinder and drivers are connected. Also, do not perform these tests on the absolute sensor part of the motor.

Actuator Installation (EAC2 Only)

When installing the **EAC2** actuator, pay particular attention to the installation location, because the encoder can easily be affected by magnetic force. When installing the motor parts in parallel, leave a buffer space that is equal to or greater than the motor's size (frame size) both horizontally and vertically.

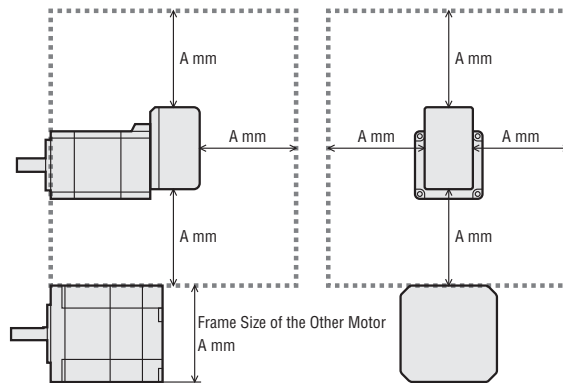

● Reference

The Other Motor	A
Frame Size 20 mm	20 mm
Frame Size 28 mm	28 mm
Frame Size 42 mm	42 mm
Frame Size 60 mm	60 mm

● Leave a buffer space equal to or greater than the motor's frame size (A mm).

Driver Specifications (AZ Series)

● General Specifications

AC Input: DC Input:

Item	AC Input		DC Input	
	Built-in Controller Type	Pulse Input Type	Built-in Controller Type	Pulse Input Type
Insulation Resistance	100 M Ω or more when a 500 VDC megger is applied between the following places: • Protective Earth Terminal – Power Supply Terminal • Encoder Connector – Power Supply Terminal • I/O Signal Terminal – Power Supply Terminal		100 M Ω or more when a 500 VDC megger is applied between the following places: • Protective Earth Terminal – Power Supply Terminal	
Dielectric Strength	Sufficient to withstand the following for 1 minute: • Protective Earth Terminal – Power Supply Terminal 1.5 kVAC, 50 Hz or 60 Hz • Encoder Connector – Power Supply Terminal 1.8 kVAC, 50 Hz or 60 Hz • I/O Signal Terminal – Power Supply Terminal 1.8 kVAC, 50 Hz or 60 Hz		-	
Operating Environment (In operation)	Ambient Temperature	0 ~ +55°C (Non-freezing)*		0 ~ +50°C (Non-freezing)
	Ambient Humidity	85% or less (Non-condensing)		
	Atmosphere	No corrosive gases or dust. The product should not be exposed to water, oil or other liquids.		
Degree of Protection	IP10	IP20	IP10	
Multiple Rotation Detection Range in Power OFF State	EAC2: \pm 450 Rotation (900 Rotations) EAC4, EAC6: \pm 900 Rotations (1800 Rotations)			

* When a heat sink is installed that is equivalent to an aluminum plate with the dimensions 200 × 200 mm and 2 mm thickness

Note

- Do not measure insulation resistance or perform a dielectric strength test while the electric cylinder and drivers are connected.

● Power Supply Input Specifications (AZ Series)

◇ AC Input Type (Built-in Controller Type, Pulse Input Type)

Item		EAC4	EAC6
Power Supply Input	Voltage and Frequency	Single-phase 200-240 VAC -15~+6%, 50/60 Hz	
	Input Current A	1.7	2.3
Control Power Supply		24 VDC ±5%*1 0.25 A (0.33 A)*2	24 VDC ±5%*1 0.25 A (0.5 A)*2

*1 For the type with an electromagnetic brake, the 24 VDC ±4% specification applies if the wiring distance between the motor and driver is extended to 20 m using an accessory cable (sold separately).

*2 The brackets () indicate the specifications for the product with an electromagnetic brake.

◇ DC Input Type (Built-in Controller Type, Pulse Input Type)

Item		EAC2	EAC4	EAC6
Power Supply Input	Voltage	24 VDC ±5%	24 VDC ±5%*1/48 VDC ±5%	
	Input Current A	1.6	1.72 (1.8)*2	3.55 (3.8)*2

*1 For the type with an electromagnetic brake, the 24 VDC ±4% specification applies if the wiring distance between the motor and driver is extended to 20 m using an accessory cable (sold separately).

*2 The brackets () indicate the specifications for the type with an electromagnetic brake.

● Built-in Controller Type RS-485 Communication Specifications

Protocol	Modbus RTU Mode
Electrical Characteristics	EIA-485 Based, Straight Cable Use shielded twisted-pair cables (TIA/EIA-568B CAT5e or better recommended). The max. total extension length is 50 m.
Communication Mode	Half duplex and start-stop synchronization (data: 8 bits, stop bit: 1 bit or 2 bits, parity: none, even, or odd)
Baud Rate	9600 bps/19200 bps/38400 bps/57600 bps/115200 bps/230400 bps are available
Connection Type	Up to 31 units can be connected to a single programmable controller (master equipment).

Overview,
Product
Series

Electric
Linear
Slides

Q_{STEP}
AZ/AR
EAS

Q_{STEP}
AZ/AR
EZS

Electric
Cylinders

Q_{STEP}
AZ/AR
EAC

Compact
Linear
Actuators

Q_{STEP}
AZ
DRS2

DRLII

Installation

Hollow
Rotary
Actuators

Q_{STEP}
AZ/AR
DGII

Accessories

Dimensions (Unit: mm)

- Electric Cylinder
- ◇ EAC2 Straight Type

α STEP
AZ
Equipped

α STEP
AR
Equipped

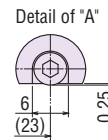
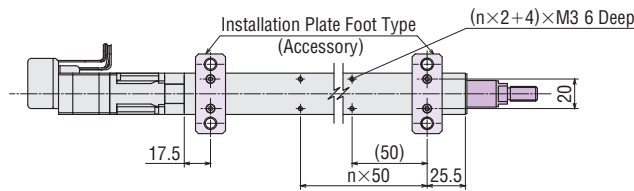
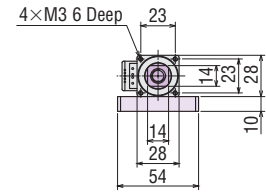
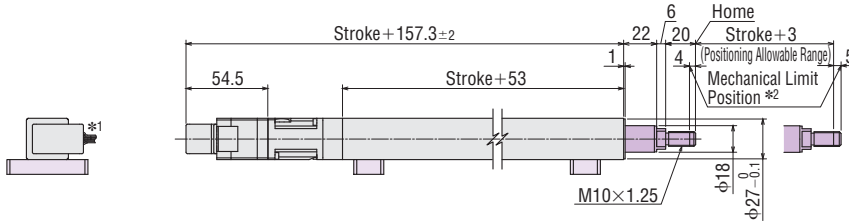
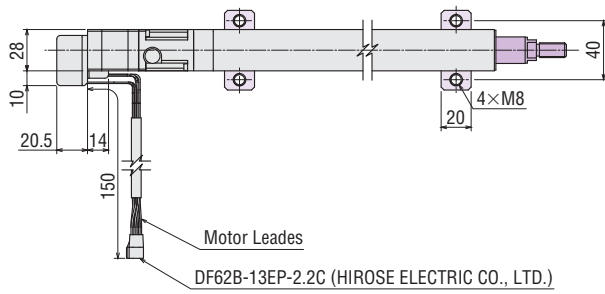

● Included Nut (1 pc)

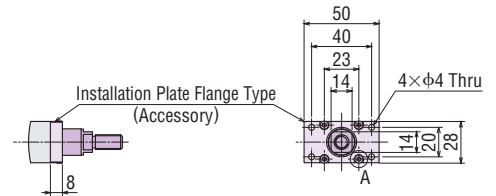
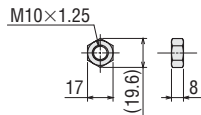

*1 The motor leads outlet direction can be changed in 90° intervals in four directions.

*2 At the push-motion return-to-home operation, the rod moves to the mechanical limit position. The push-motion return-to-home operation cannot move the rod to the far end from the motor.

● The shaded areas are moving parts.

● The shaded areas are installation plates (accessories).

Stroke [mm]		50	100	150
Hole Coefficient (n)		1	2	3
Mass [kg]	Single Shaft	0.46	0.54	0.61

◇ **EAC2W** Straight Type with Shaft Guide Cover

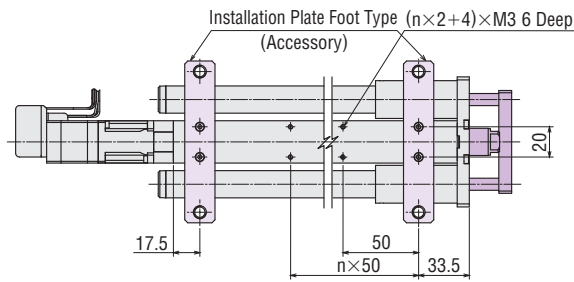
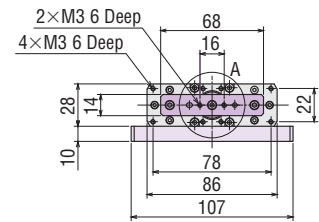
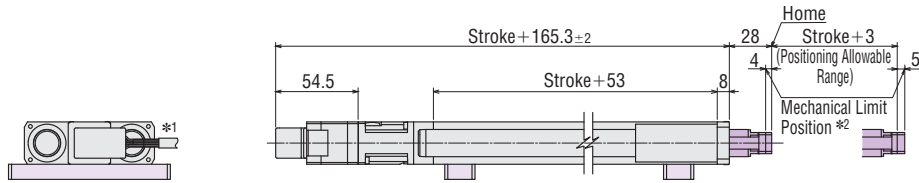
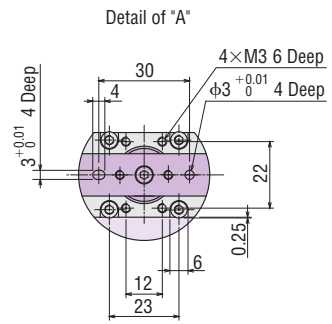
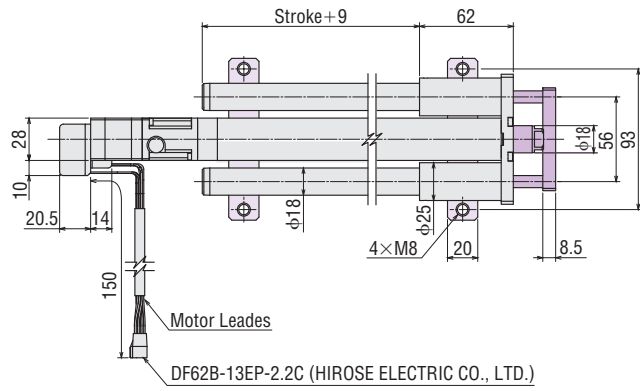

*1 The motor leads outlet direction can be changed in 90° intervals in four directions.

*2 At the push-motion return-to-home operation, the rod moves to the mechanical limit position. The push-motion return-to-home operation cannot move the rod to the far end from the motor.

● The shaded areas are moving parts.

● The shaded areas are installation plates (accessories).

Stroke [mm]		50	100	150
Hole Coefficient (n)		1	2	3
Mass [kg]	Single Shaft	0.78	0.92	1.10

Overview, Product Series

Electric Linear Slides

Q₁STEP AZ/AR EAS

Q₁STEP AZ/AR EZS

Electric Cylinders

Q₁STEP AZ/AR EAC

Compact Linear Actuators

Q₁STEP AZ DRS2

DRLII

Installation

Hollow Rotary Actuators

Q₁STEP AZ/AR DGII

Accessories

◇ EAC4 Straight Type

α STEP
AZ
Equipped

α STEP
AR
Equipped

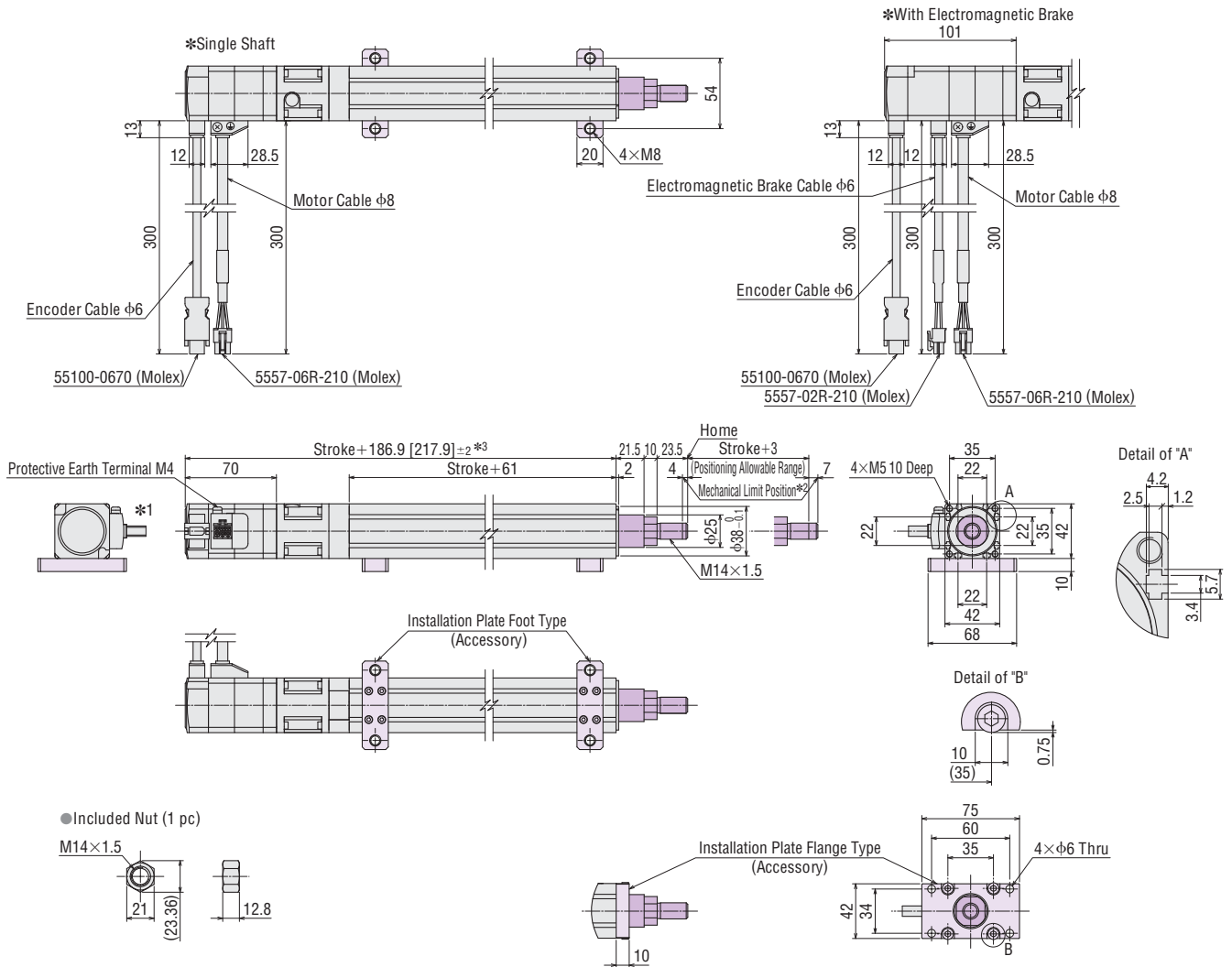

- *1 The motor leads outlet direction can be changed in 90° intervals in four directions.
- *2 At the push-motion return-to-home operation, the rod moves to the mechanical limit position. The push-motion return-to-home operation cannot move the rod to the far end from the motor.
- *3 The brackets [] indicate the values for the electromagnetic brake product.
- The shaded areas are moving parts.
- The shaded areas are installation plates (accessories).

Stroke [mm]		50	100	150	200	250	300
Mass [kg]	Single Shaft	1.0	1.2	1.4	1.6	1.7	1.9
	With Electromagnetic Brake	1.2	1.4	1.6	1.8	1.9	2.1

◇ EAC4R Reversed Motor Type

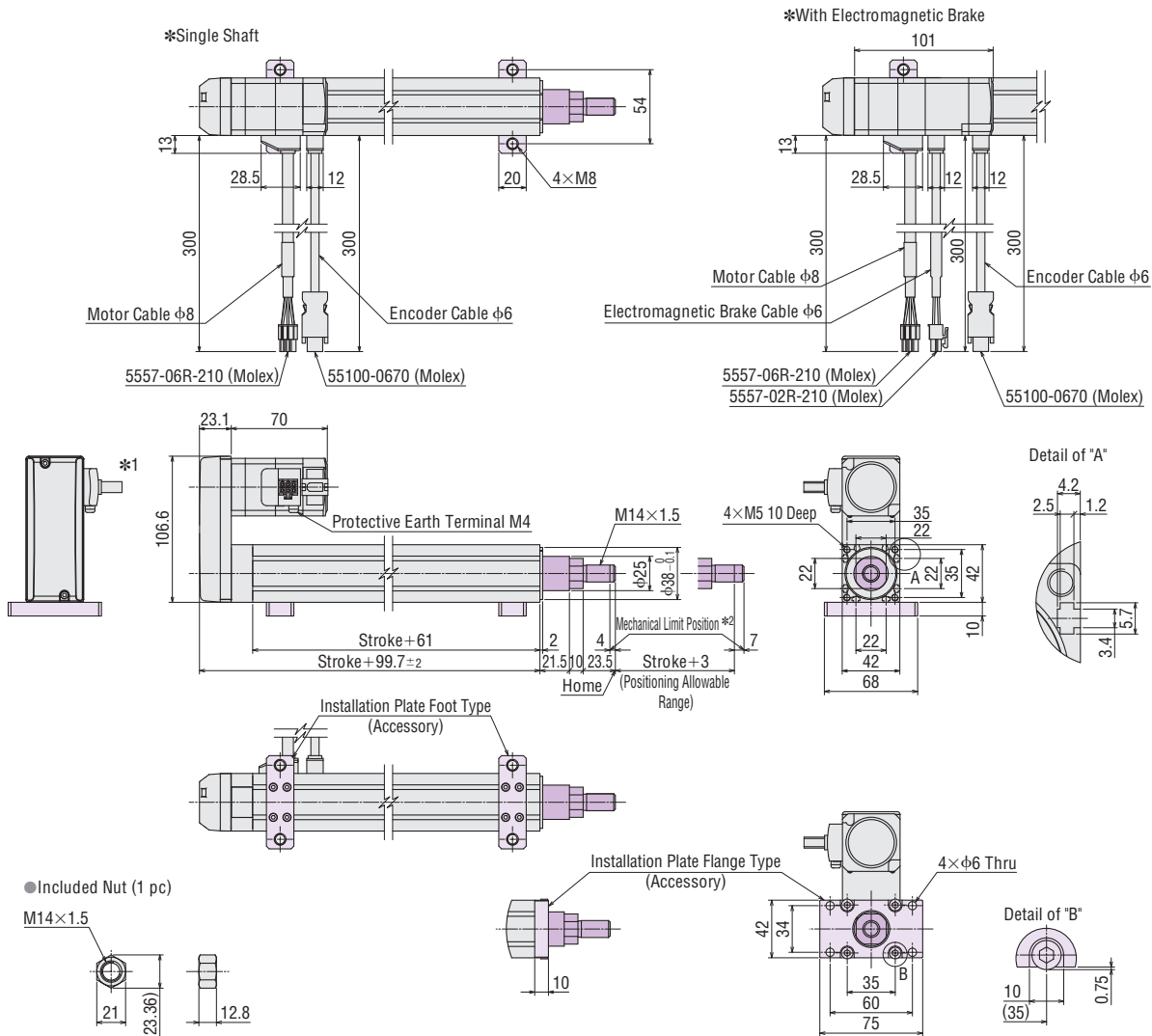

- *1 The motor leads outlet direction can be changed in 90° intervals in three directions.
- *2 At the push-motion return-to-home operation, the rod moves to the mechanical limit position. The push-motion return-to-home operation cannot move the rod to the far end from the motor.
- The shaded areas are moving parts.
- The shaded areas are installation plates (accessories).

Stroke [mm]		50	100	150	200	250	300
Mass [kg]	Single Shaft	1.0	1.2	1.4	1.6	1.7	1.9
	With Electromagnetic Brake	1.2	1.4	1.6	1.8	1.9	2.1

Overview, Product Series

Electric Linear Slides

Q⁺STEP AZ/AR EAS

Q⁺STEP AZ/AR EZS

Electric Cylinders

Q⁺STEP AZ/AR EAC

Compact Linear Actuators

Q⁺STEP AZ DRS2

DRLII

Installation

Hollow Rotary Actuators

Q⁺STEP AZ/AR DGII

Accessories

◇ EAC6 Straight Type

α STEP
AZ
Equipped

α STEP
AR
Equipped

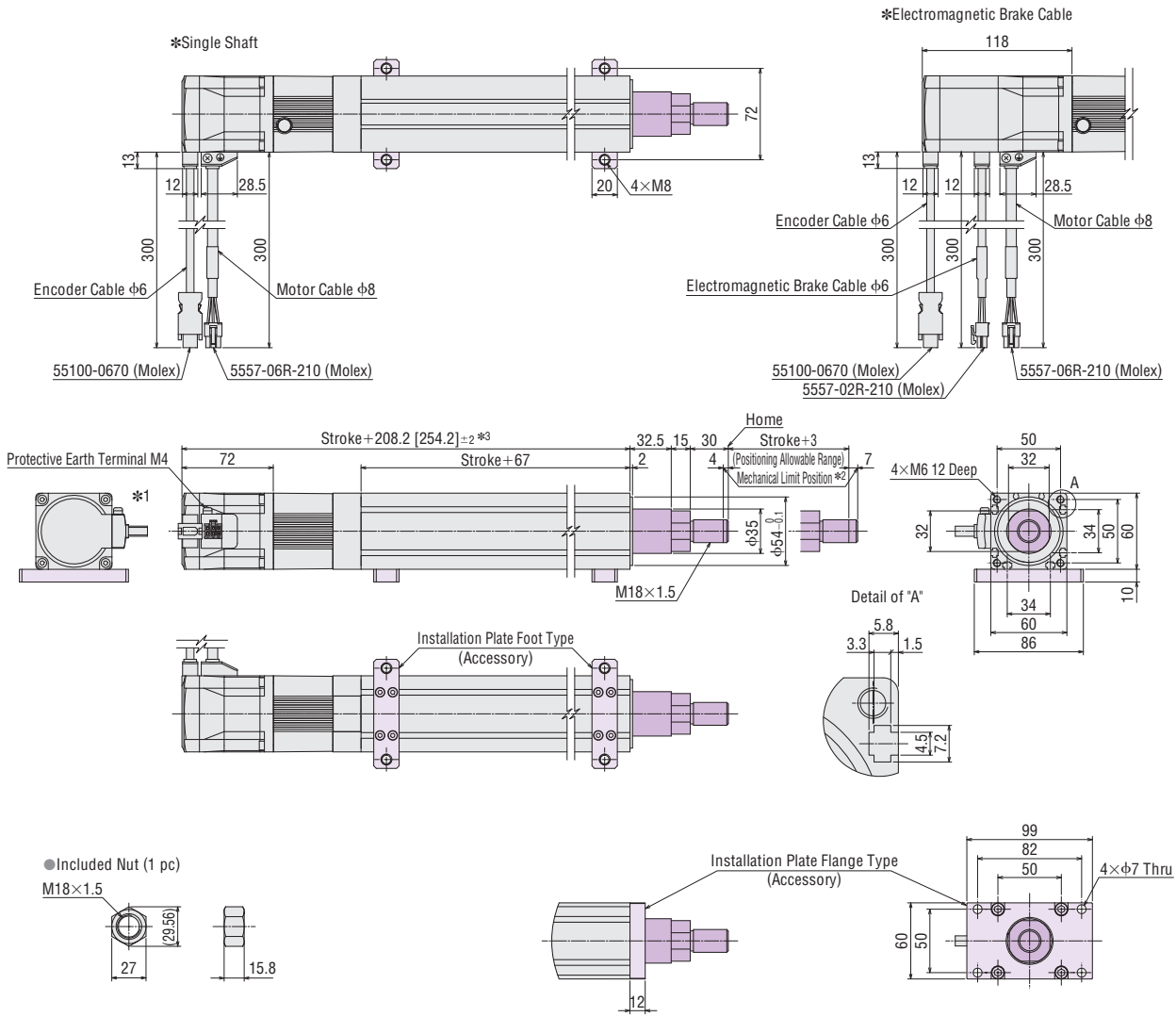

- *1 The motor leads outlet direction can be changed in 90° intervals in four directions.
- *2 At the push-motion return-to-home operation, the rod moves to the mechanical limit position. The push-motion return-to-home operation cannot move the rod to the far end from the motor.
- *3 The brackets [] indicate the values for the electromagnetic brake product.
- The shaded areas are moving parts.
- The shaded areas are installation plates (accessories).

Stroke [mm]	50	100	150	200	250	300
Single Shaft	2.6	3.0	3.4	3.7	4.1	4.5
With Electromagnetic Brake	3.0	3.4	3.8	4.1	4.5	4.9

◇ EAC6R Reversed Motor Type

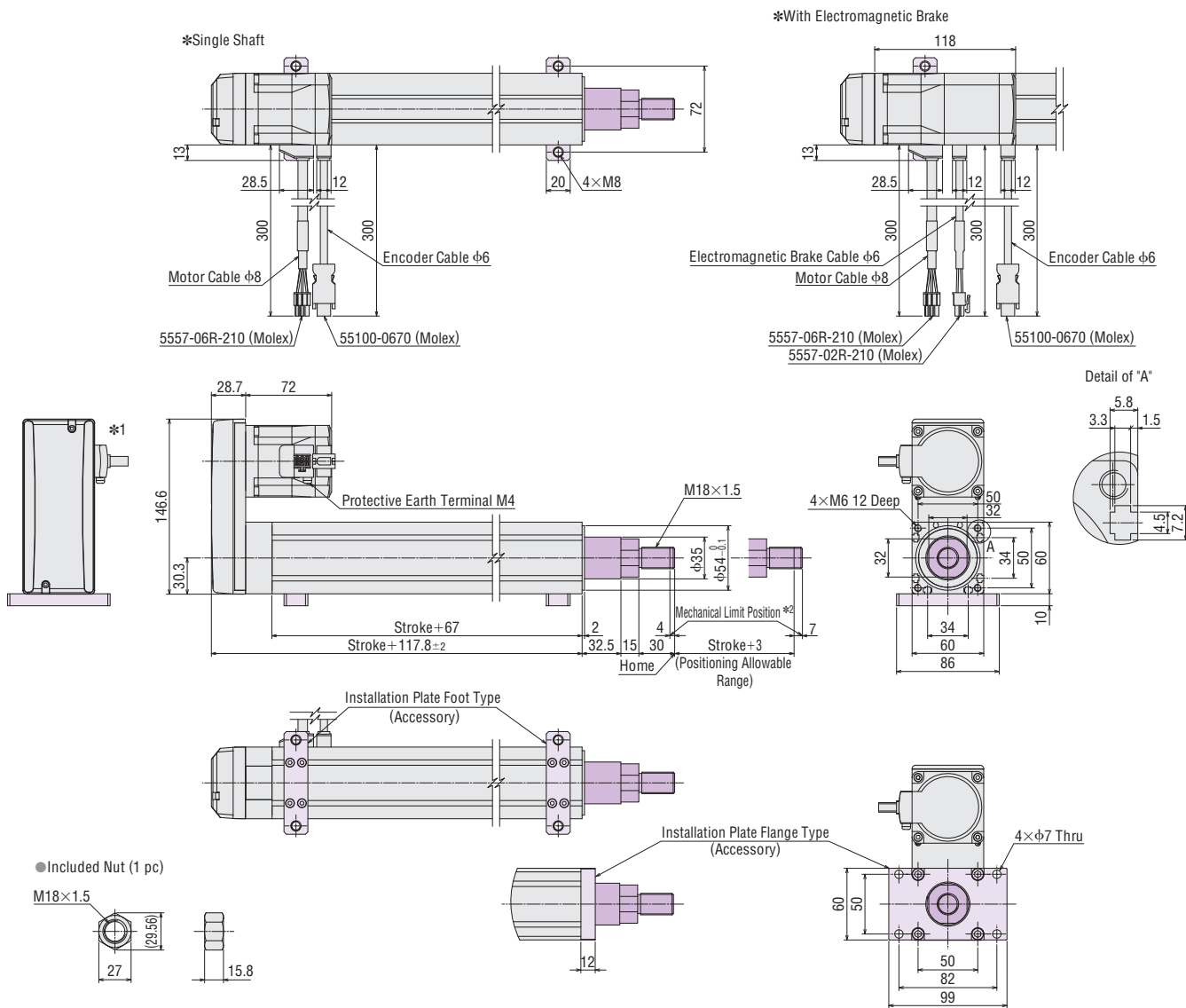

- *1 The motor leads outlet direction can be changed in 90° intervals in three directions.
- *2 At the push-motion return-to-home operation, the rod moves to the mechanical limit position. The push-motion return-to-home operation cannot move the rod to the far end from the motor.
- The shaded areas are moving parts.
- The shaded areas are installation plates (accessories).

Stroke [mm]		50	100	150	200	250	300
Mass [kg]	Single Shaft	2.6	3.0	3.4	3.7	4.1	4.5
	With Electromagnetic Brake	3.0	3.4	3.8	4.1	4.5	4.9

Overview, Product Series

Electric Linear Slides

Q^{STEP} AZ/AR EAS

Q^{STEP} AZ/AR EZS

Electric Cylinders

Q^{STEP} AZ/AR EAC

Compact Linear Actuators

Q^{STEP} AZ DRS2

DRLII

Installation

Hollow Rotary Actuators

Q^{STEP} AZ/AR DGII

Accessories

◇ **EAC4W** Straight Type with Shaft Guide/Shaft Guide Cover

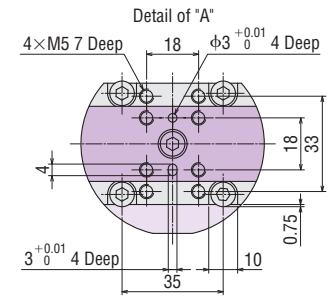
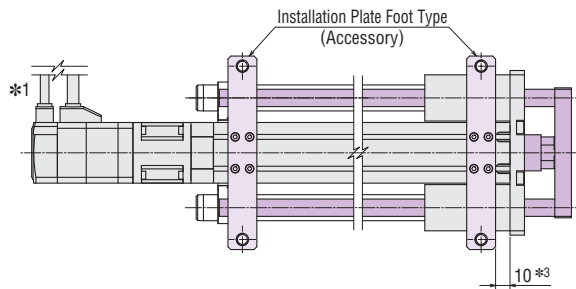
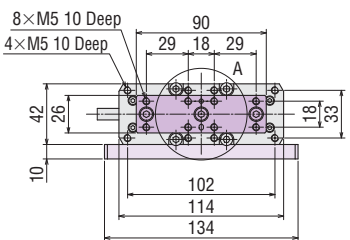
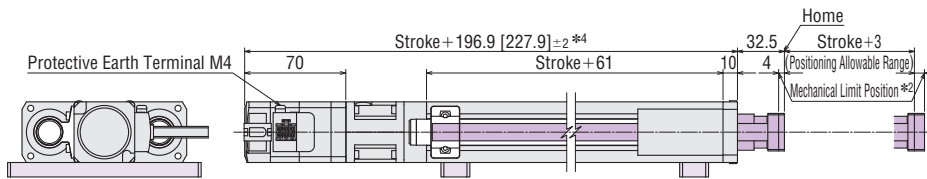
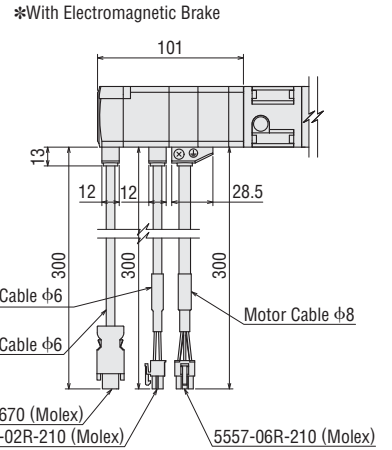
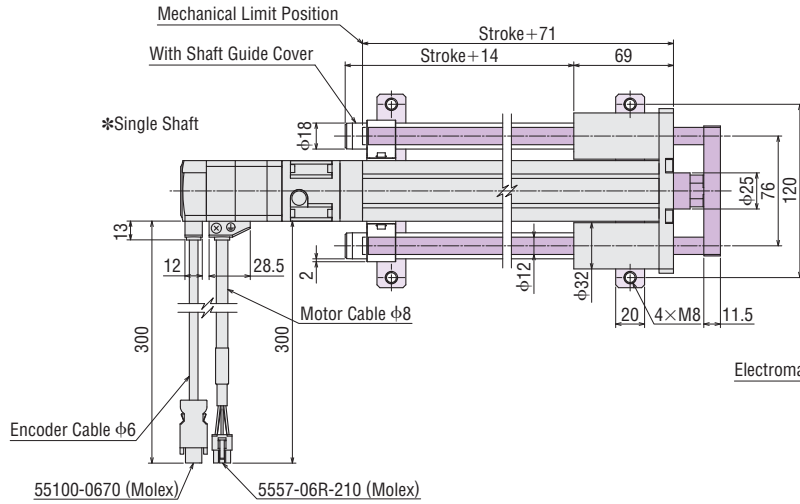

- *1 The motor leads outlet direction can be changed in 90° intervals in four directions.
- *2 At the push-motion return-to-home operation, the rod moves to the mechanical limit position. The push-motion return-to-home operation cannot move the rod to the far end from the motor.
- *3 The installation plate foot type cannot be installed onto this part.
- *4 The brackets [] indicate the values for the electromagnetic brake product.
- The shaded areas are moving parts.
- The shaded areas are installation plates (accessories).

Stroke [mm]		50	100	150	200	250	300
Mass [kg]	With Shaft Guide	1.7 (1.9)	2.0 (2.2)	2.3 (2.5)	2.5 (2.7)	2.8 (3.0)	3.1 (3.3)
	With Shaft Guide Cover	1.8 (1.9)	2.1 (2.3)	2.4 (2.6)	2.6 (2.8)	3.0 (3.1)	3.3 (3.5)

● Values in () indicate the mass of the type with an electromagnetic brake.

α STEP
AZ
Equipped

α STEP
AR
Equipped

◇ EAC4RW Reversed Motor Type with Shaft Guide/Shaft Guide Cover

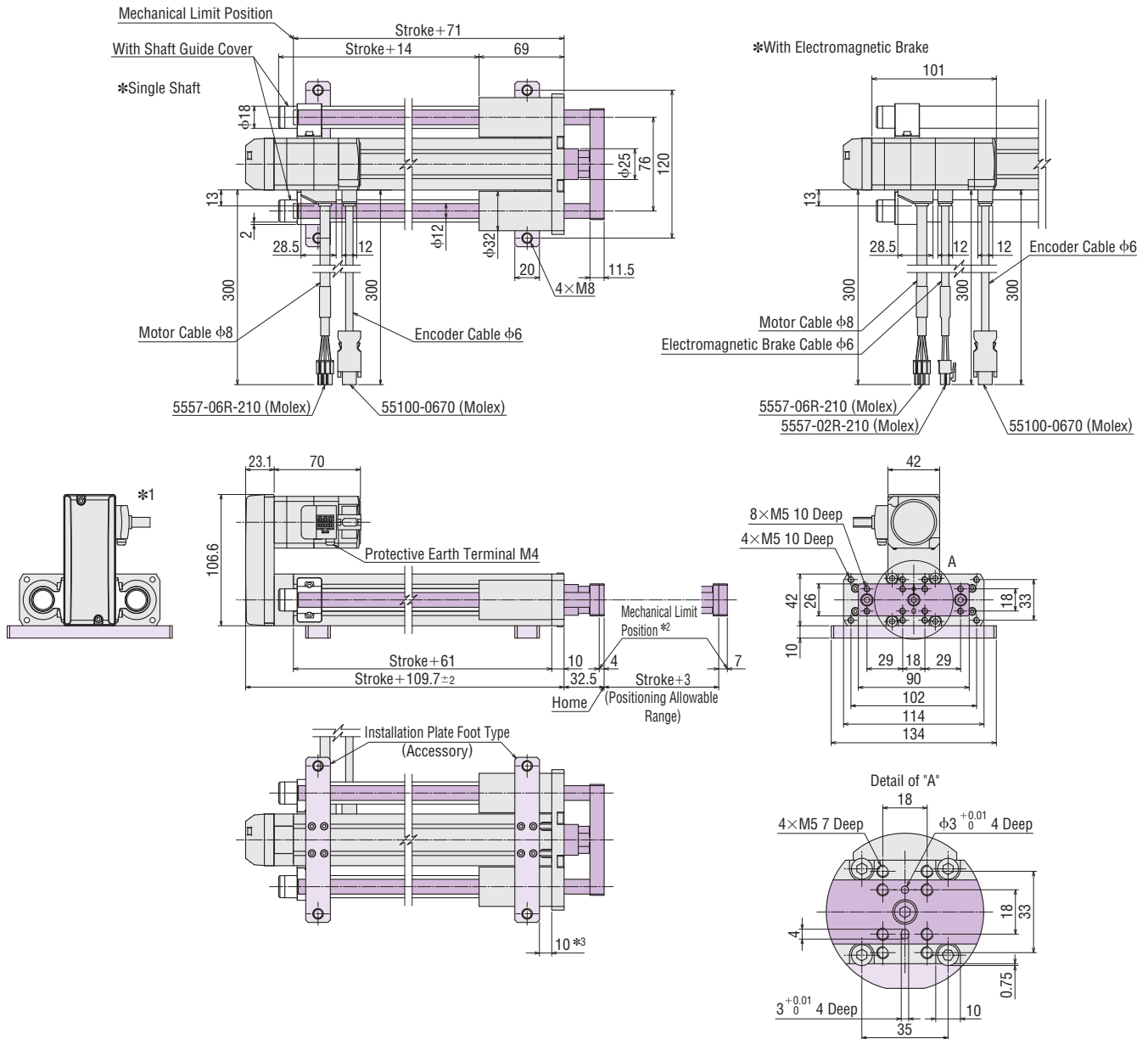

- *1 The motor leads outlet direction can be changed in 90° intervals in three directions.
- *2 At the push-motion return-to-home operation, the rod moves to the mechanical limit position. The push-motion return-to-home operation cannot move the rod to the far end from the motor.
- *3 The installation plate foot type cannot be installed onto this part.
- The shaded areas are moving parts.
- The shaded areas are installation plates (accessories).

Stroke [mm]	50	100	150	200	250	300	
Mass [kg]	With Shaft Guide	1.7 (1.9)	2.0 (2.2)	2.3 (2.5)	2.5 (2.7)	2.8 (3.0)	3.1 (3.3)
	With Shaft Guide Cover	1.8 (1.9)	2.1 (2.3)	2.4 (2.6)	2.6 (2.8)	3.0 (3.1)	3.3 (3.5)

● Values in () indicate the mass of the type with an electromagnetic brake.

Overview,
Product
Series

Electric
Linear
Slides

Q₁STEP
AZ/AR
EAS

Q₁STEP
AZ/AR
EZS

Electric
Cylinders

Q₁STEP
AZ/AR
EAC

Compact
Linear
Actuators

Q₁STEP
AZ
DRS2

DRLII

Installation

Hollow
Rotary
Actuators

Q₁STEP
AZ/AR
DGII

Accessories

◇ **EAC6W** Straight Type with Shaft Guide/Shaft Guide Cover

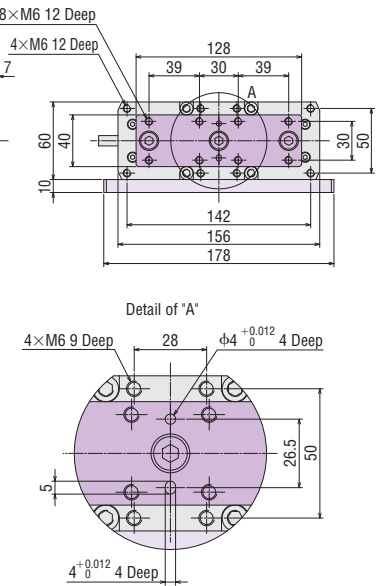
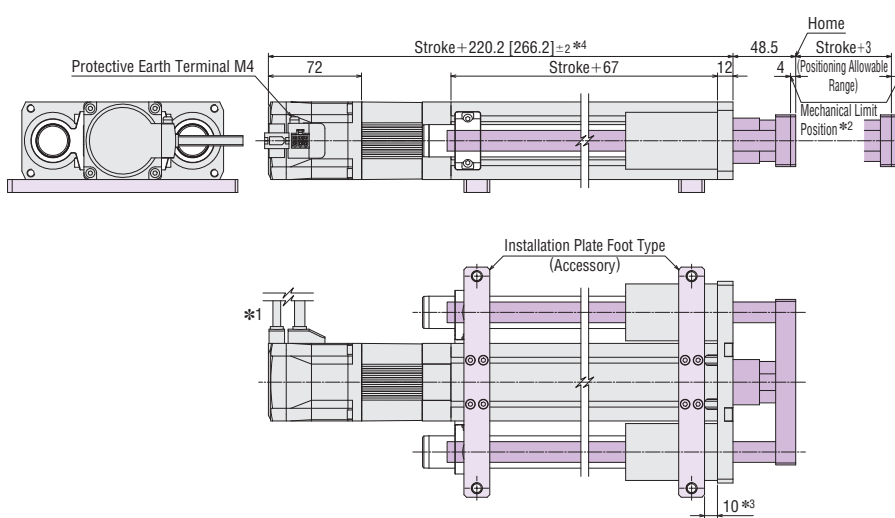
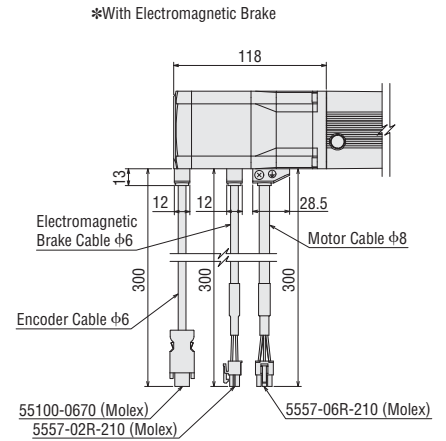
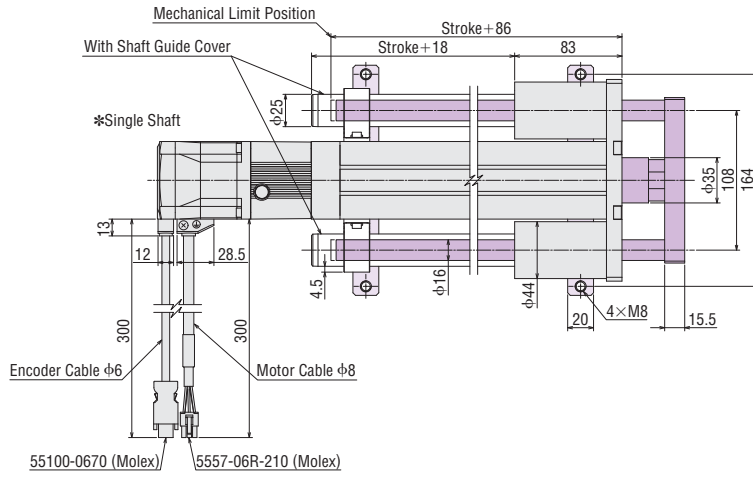

- *1 The motor leads outlet direction can be changed in 90° intervals in four directions.
- *2 At the push-motion return-to-home operation, the rod moves to the mechanical limit position. The push-motion return-to-home operation cannot move the rod to the far end from the motor.
- *3 The installation plate foot type cannot be installed onto this part.
- *4 The brackets [] indicate the values for the electromagnetic brake product.
- The shaded areas are moving parts.
- The shaded areas are installation plates (accessories).

Stroke [mm]		50	100	150	200	250	300
Mass [kg]	With Shaft Guide	4.1 (4.5)	4.7 (5.1)	5.2 (5.6)	5.7 (6.1)	6.3 (6.7)	6.8 (7.2)
	With Shaft Guide Cover	4.2 (4.6)	4.9 (5.3)	5.4 (5.8)	6.0 (6.4)	6.6 (7.0)	7.2 (7.6)

● Values in () indicate the mass of the type with an electromagnetic brake.

α STEP
AZ
Equipped

α STEP
AR
Equipped

◇ EAC6RW Reversed Motor Type with Shaft Guide/Shaft Guide Cover

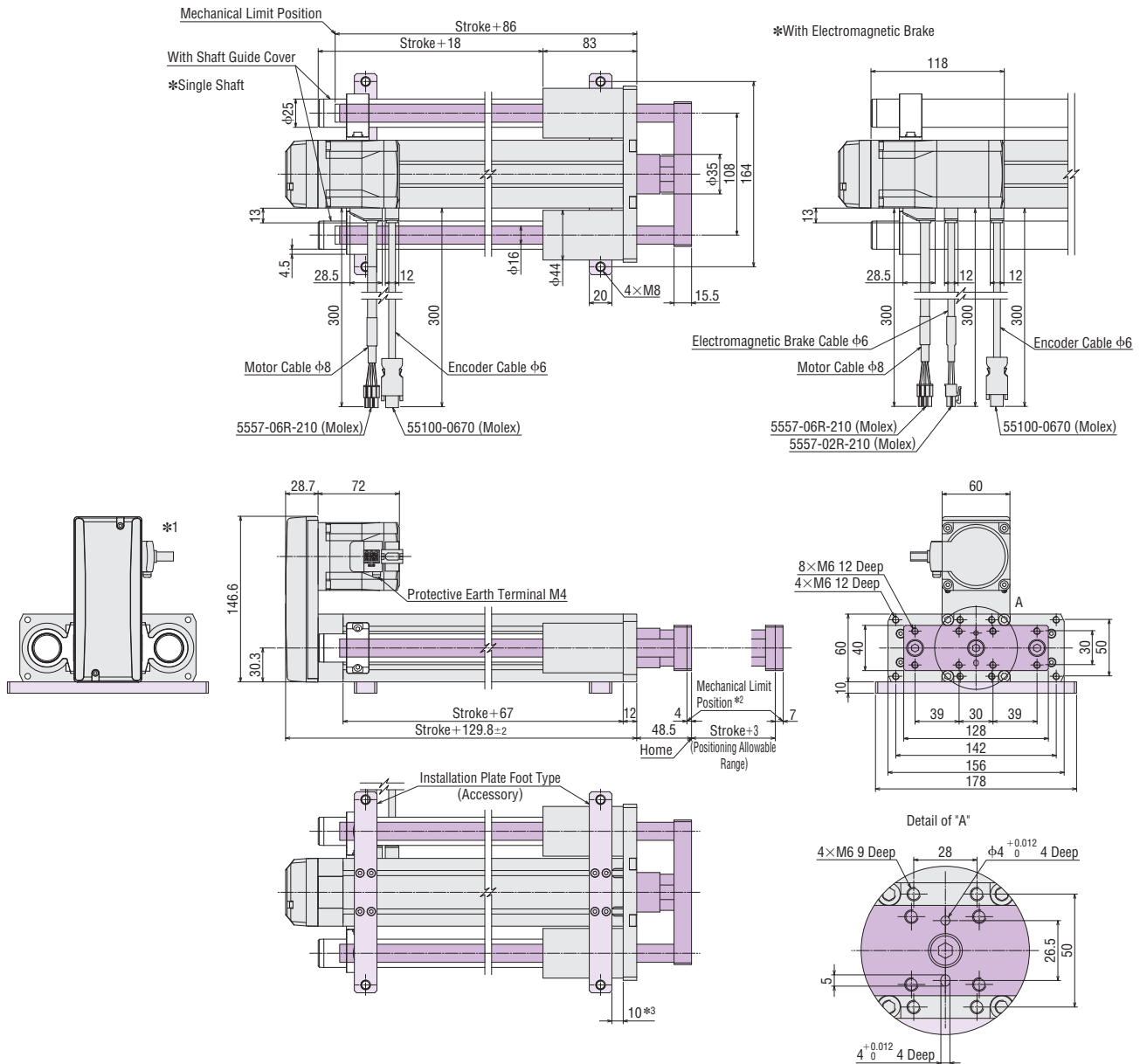

- *1 The motor leads outlet direction can be changed in 90° intervals in three directions.
- *2 At the push-motion return-to-home operation, the rod moves to the mechanical limit position. The push-motion return-to-home operation cannot move the rod to the far end from the motor.
- *3 The installation plate foot type cannot be installed onto this part.
- The shaded areas are moving parts.
- The shaded areas are installation plates (accessories).

Stroke [mm]	50	100	150	200	250	300	
Mass [kg]	With Shaft Guide	4.1 (4.5)	4.7 (5.1)	5.2 (5.6)	5.7 (6.1)	6.3 (6.7)	6.8 (7.2)
	With Shaft Guide Cover	4.2 (4.6)	4.9 (5.3)	5.4 (5.8)	6.0 (6.4)	6.6 (7.0)	7.2 (7.6)

● Values in () indicate the mass of the type with an electromagnetic brake.

Overview, Product Series

Electric Linear Slides

Q^{STEP} AZ/AR EAS

Q^{STEP} AZ/AR EZS

Electric Cylinders

Q^{STEP} AZ/AR EAC

Compact Linear Actuators

Q^{STEP} AZ DRS2

DRLII

Installation

Hollow Rotary Actuators

Q^{STEP} AZ/AR DGII

Accessories

● Driver

◇ Built-in Controller Type AC Input (AZD-CD)

Mass: 0.65 kg

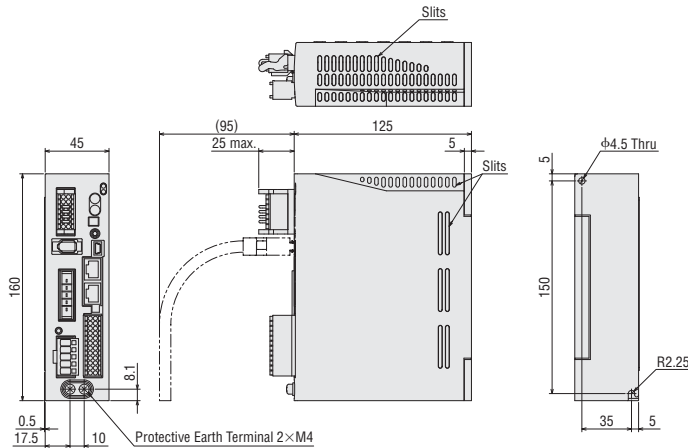
 α STEP
AZ
Equipped α STEP
AR
Equipped

◇ Built-in Controller Type DC Input (AZD-KD)

Mass: 0.15 kg

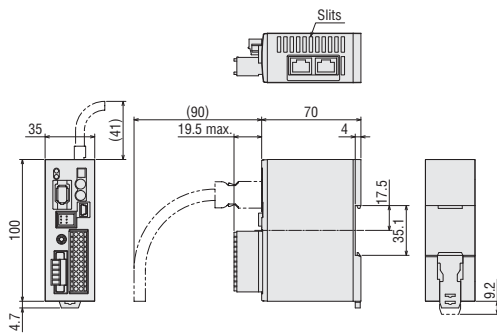

◇ Pulse Input Type AC Input (AZD-C)

Mass: 0.65 kg

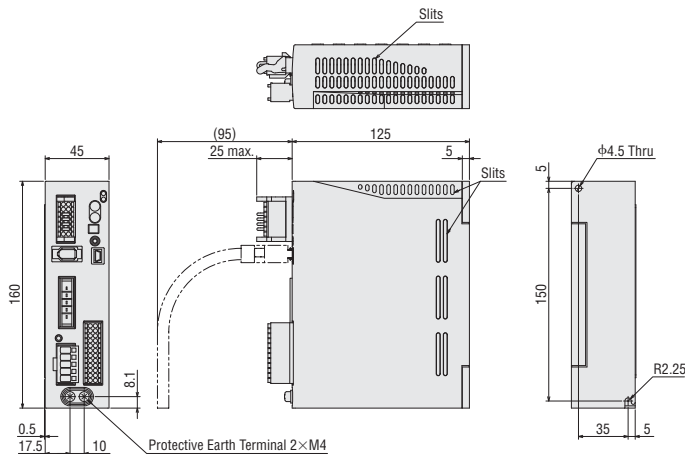

◇ Pulse Input Type DC Input (AZD-K)

Mass: 0.15 kg

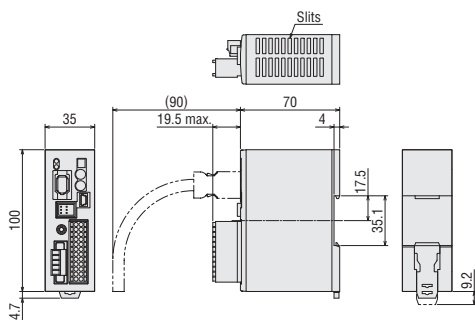

● Included

Connector for Main Power/Regeneration Unit (CN4)

Connector: 05JFAT-SAXGDK-H5.0
(J.S.T.MFG.CO.,LTD.)

I/O Signals Connector (CN5)

Connector: DFMC1,5/12-ST-3,5
(PHOENIX CONTACT)Connector for 24 VDC Power Supply Input/Electromagnetic Brake
Connection/Regeneration Unit Thermal Input/Power Shut Down Signal
I/O (CN1)Connector: DFMC1,5/7-ST-3,5-LR
(PHOENIX CONTACT)Connector Wiring Lever: J-FAT-0T
(J.S.T.MFG.CO.,LTD.)

● Included

Connector for Main Power Supply/Electromagnetic Brake Connection
(CN1)Connector: MC1,5/5-STF-3,5
(PHOENIX CONTACT)

I/O Signals Connector (CN4)

Connector: DFMC1,5/12-ST-3,5
(PHOENIX CONTACT)

● Included

Connector for Main Power/Regeneration Unit (CN4)

Connector: 05JFAT-SAXGDK-H5.0
(J.S.T.MFG.CO.,LTD.)

I/O Signals Connector (CN5)

Connector: DFMC1,5/12-ST-3,5
(PHOENIX CONTACT)Connector for 24 VDC Power Supply Input/Electromagnetic Brake
Connection/Regeneration Unit Thermal Input/Power Shut Down Signal
I/O (CN1)Connector: DFMC1,5/7-ST-3,5-LR
(PHOENIX CONTACT)Connector Wiring Lever: J-FAT-0T
(J.S.T.MFG.CO.,LTD.)

● Included

Connector for Main Power Supply/Electromagnetic Brake Connection
(CN1)Connector: MC1,5/5-STF-3,5
(PHOENIX CONTACT)

I/O Signals Connector (CN4)

Connector: DFMC1,5/12-ST-3,5
(PHOENIX CONTACT)

● Connection Cable (Only for Products with Connection Cable)

◇ AC Input

● Cable for Motor

Cable Type	Length L (m)
Cable for Motor 1 m	1
Cable for Motor 2 m	2
Cable for Motor 3 m	3

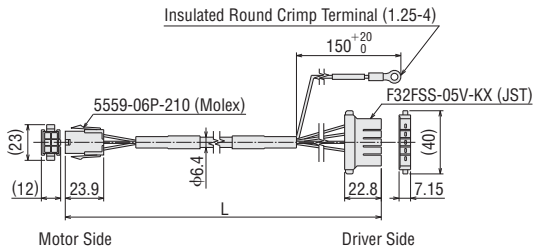

● Cable for Electromagnetic Brake (Only for Types with Electromagnetic Brake)

Cable Type	Length L (m)
Cable for Electromagnetic Brake 1 m	1
Cable for Electromagnetic Brake 2 m	2
Cable for Electromagnetic Brake 3 m	3

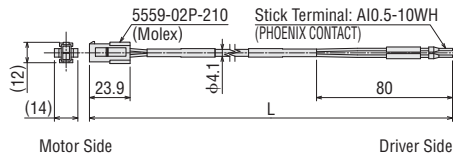

● Cable for Encoder

Cable Type	Length L (m)
Cable for Encoder 1 m	1
Cable for Encoder 2 m	2
Cable for Encoder 3 m	3

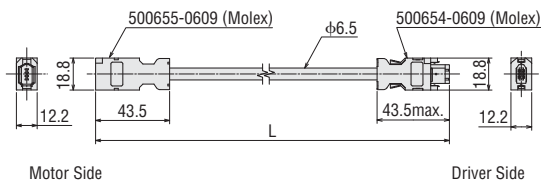

◇ For DC Input (EAC2)

● Cable for Motor

Cable Type	Length L (m)
Cable for Motor 1 m	1
Cable for Motor 2 m	2
Cable for Motor 3 m	3

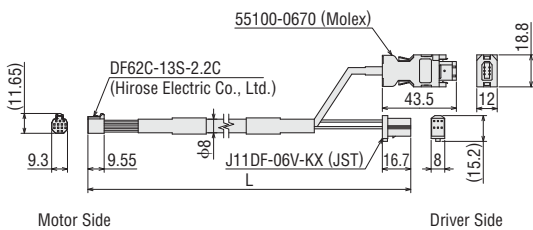

◇ For DC Input (EAC4, EAC6)

● Cable for Motor

Cable Type	Length L (m)
Cable for Motor 1 m	1
Cable for Motor 2 m	2
Cable for Motor 3 m	3

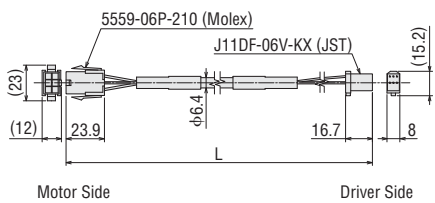

● Cable for Encoder

Cable Type	Length L (m)
Cable for Encoder 1 m	1
Cable for Encoder 2 m	2
Cable for Encoder 3 m	3

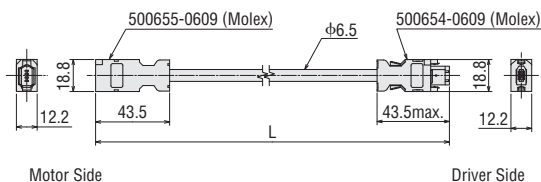

● Cable for Electromagnetic Brake (Only for Types with Electromagnetic Brake)

Cable Type	Length L (m)
Cable for Electromagnetic Brake 1 m	1
Cable for Electromagnetic Brake 2 m	2
Cable for Electromagnetic Brake 3 m	3

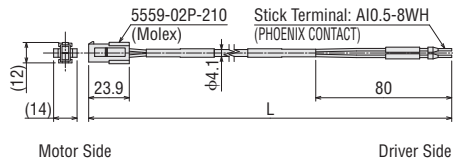

Note

● The motor cable and electromagnetic brake cable from the electric cylinder cannot be connected directly to the driver. When connecting to a driver, use the accessory connection cable (sold separately) or use the included connection cable (for products which include a connection cable).

Overview, Product Series

Electric Linear Slides

Q-STEP AZ/AR EAS

Q-STEP AZ/AR EZS

Electric Cylinders

Q-STEP AZ/AR EAC

Compact Linear Actuators

Q-STEP AZ DRS2

DRLII

Installation

Hollow Rotary Actuators

Q-STEP AZ/AR DGII

Accessories

Operating Data (Positioning Distance – Positioning Time, Operating Speed, Acceleration)

● **EAC2: Straight Type 24 VDC Input**
Lead Screw Pitch: 6 mm

◇ Horizontal Direction Installation

● Positioning Distance – Positioning Time

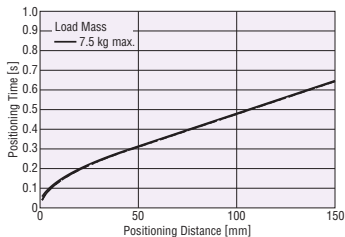

● Positioning Distance – Operating Speed

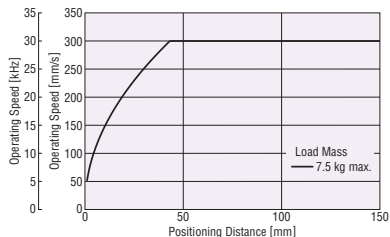

● Positioning Distance – Acceleration

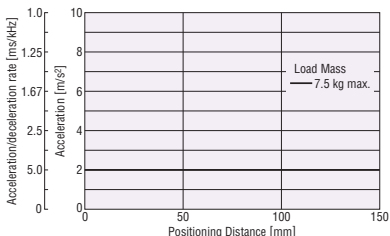

◇ Vertical Direction Installation

● Positioning Distance – Positioning Time

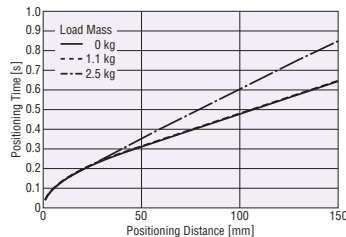

● Positioning Distance – Operating Speed

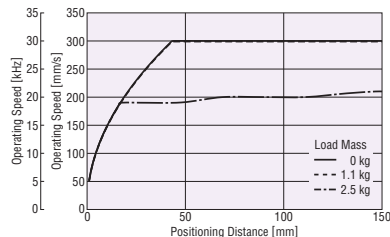

● Positioning Distance – Acceleration

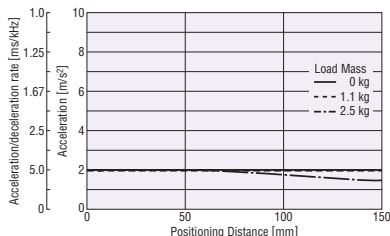

● **EAC2: Straight Type 24 VDC Input**
Lead Screw Pitch: 3 mm

◇ Horizontal Direction Installation

● Positioning Distance – Positioning Time

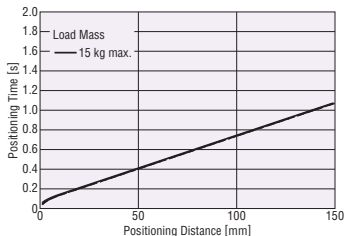

● Positioning Distance – Operating Speed

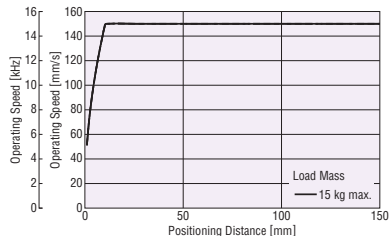

● Positioning Distance – Acceleration

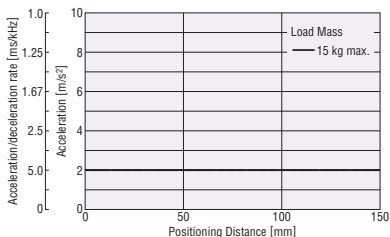

◇ Vertical Direction Installation

● Positioning Distance – Positioning Time

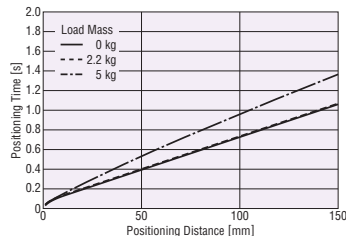

● Positioning Distance – Operating Speed

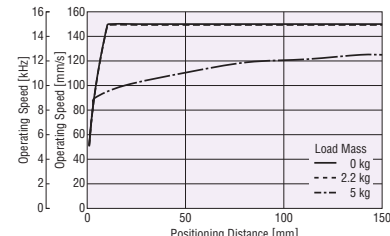

● Positioning Distance – Acceleration

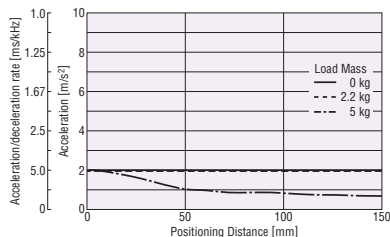

● The values for operating speed [kHz] and acceleration/deceleration rate [ms/kHz] in the above graphs apply when the minimum traveling amount for the electric cylinders is set to 0.01 mm.

● **EAC2: Straight Type with Shaft Guide Cover 24 VDC Input**
Lead Screw Pitch: 6 mm

◇ Horizontal Direction Installation

● Positioning Distance – Positioning Time

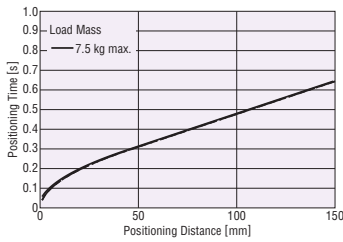

● Positioning Distance – Operating Speed

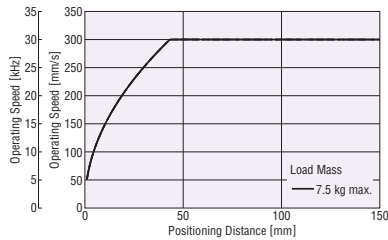

● Positioning Distance – Acceleration

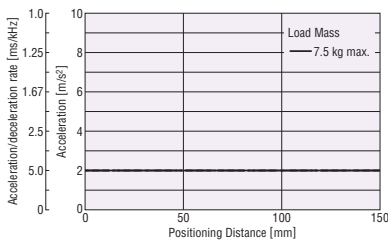

◇ Vertical Direction Installation

● Positioning Distance – Positioning Time

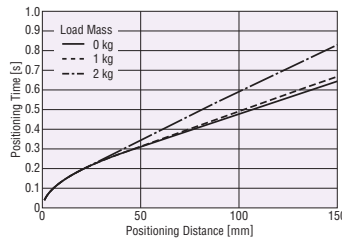

● Positioning Distance – Operating Speed

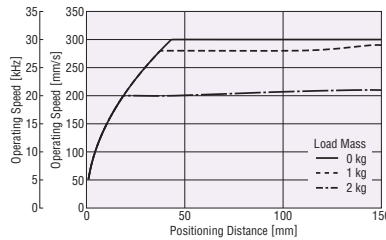

● Positioning Distance – Acceleration

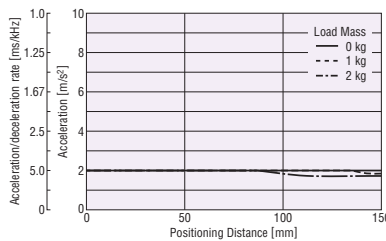

● **EAC2: Straight Type with Shaft Guide Cover 24 VDC Input**
Lead Screw Pitch: 3 mm

◇ Horizontal Direction Installation

● Positioning Distance – Positioning Time



● Positioning Distance – Operating Speed



● Positioning Distance – Acceleration

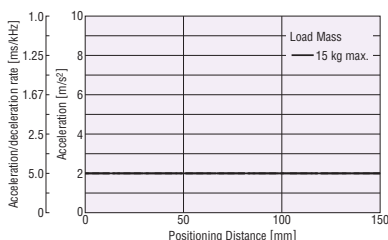

◇ Vertical Direction Installation

● Positioning Distance – Positioning Time

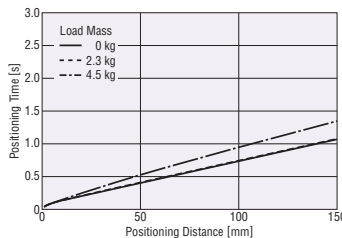

● Positioning Distance – Operating Speed

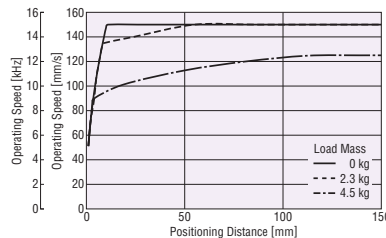

● Positioning Distance – Acceleration

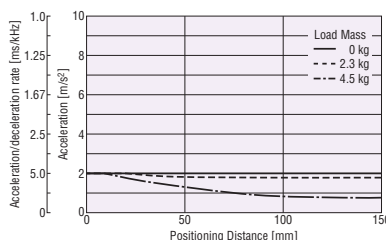

● The values for operating speed [kHz] and acceleration/deceleration rate [ms/kHz] in the above graphs apply when the minimum traveling amount for the electric cylinders is set to 0.01 mm.

Overview,
Product
Series

Electric
Linear
Slides

Q¹STEP
AZ/AR
EAS

Q¹STEP
AZ/AR
EZS

Electric
Cylinders

Q¹STEP
AZ/AR
EAC

Compact
Linear
Actuators

Q¹STEP
AZ
DRS2

DRLII

Installation

Hollow
Rotary
Actuators

Q¹STEP
AZ/AR
DGII

Accessories

α STEP
AZ
Equipped

α STEP
AR
Equipped

● **EAC4: Straight Type AC Input**
Lead Screw Pitch: 12 mm

◇ Horizontal Direction Installation

● Positioning Distance – Positioning Time

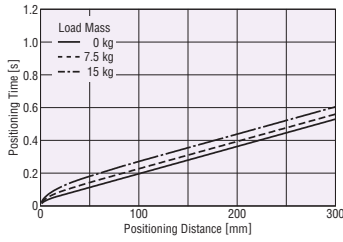

● Positioning Distance – Operating Speed

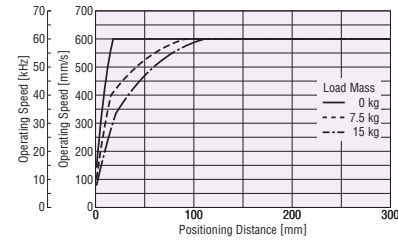

● Positioning Distance – Acceleration

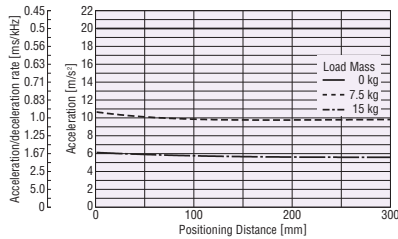

◇ Vertical Direction Installation

● Positioning Distance – Positioning Time

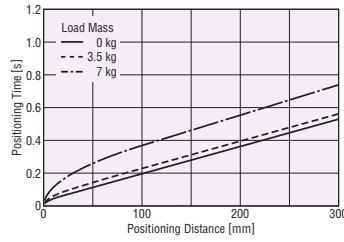

● Positioning Distance – Operating Speed

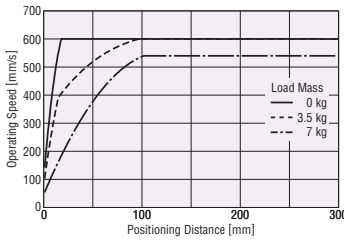

● Positioning Distance – Acceleration

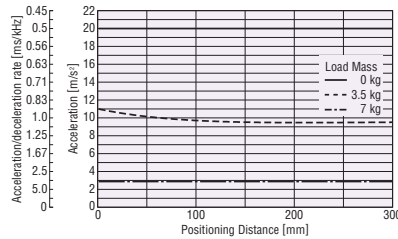

● **EAC4: Straight Type AC Input**
Lead Screw Pitch: 6 mm

◇ Horizontal Direction Installation

● Positioning Distance – Positioning Time

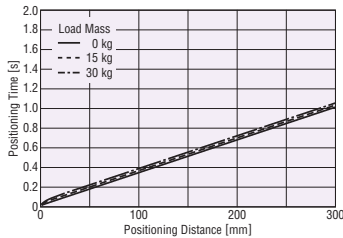

● Positioning Distance – Operating Speed

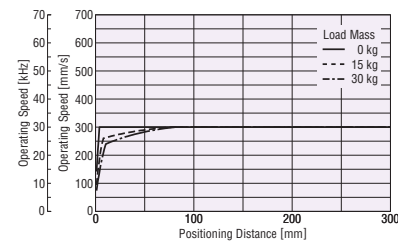

● Positioning Distance – Acceleration

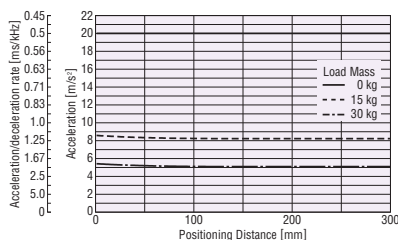

◇ Vertical Direction Installation

● Positioning Distance – Positioning Time

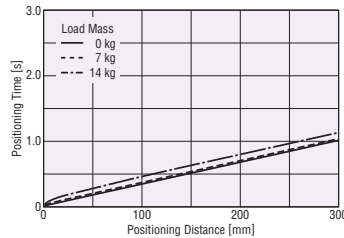

● Positioning Distance – Operating Speed

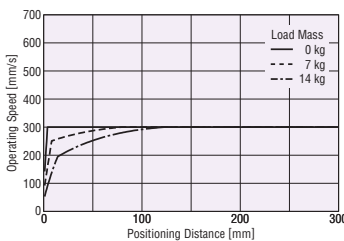

● Positioning Distance – Acceleration

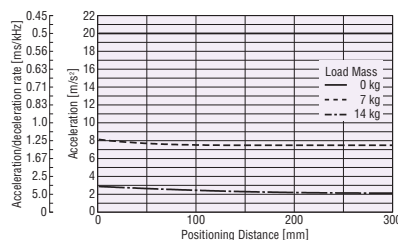

● The values for operating speed [kHz] and acceleration/deceleration rate [ms/kHz] in the above graphs apply when the minimum traveling amount for the electric cylinders is set to 0.01 mm.

● **EAC4: Reversed Motor Type AC Input**
Lead Screw Pitch: 12 mm

- ◇ Horizontal Direction Installation
- Positioning Distance – Positioning Time

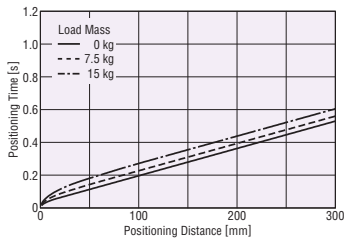

- Positioning Distance – Operating Speed

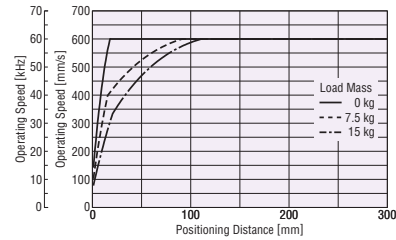

- Positioning Distance – Acceleration

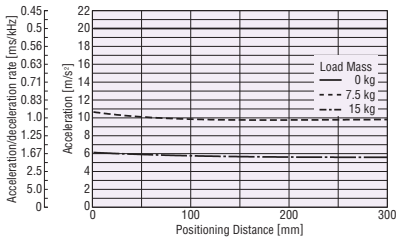

● **EAC4: Reversed Motor Type AC Input**
Lead Screw Pitch: 6 mm

- ◇ Horizontal Direction Installation
- Positioning Distance – Positioning Time

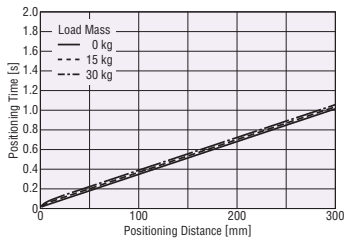

- Positioning Distance – Operating Speed

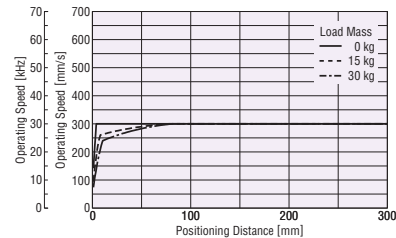

- Positioning Distance – Acceleration

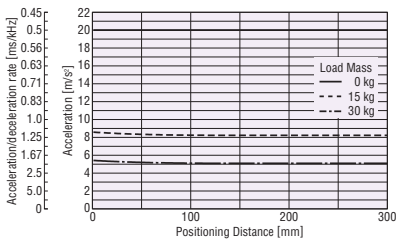

- ◇ Vertical Direction Installation
- Positioning Distance – Positioning Time

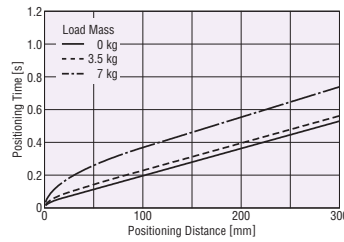

- Positioning Distance – Operating Speed

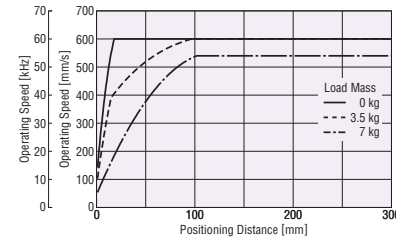

- Positioning Distance – Acceleration

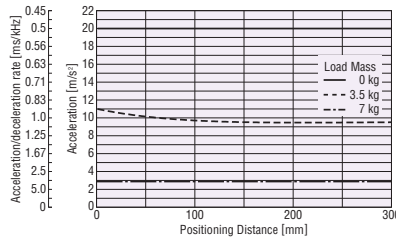

- ◇ Vertical Direction Installation
- Positioning Distance – Positioning Time

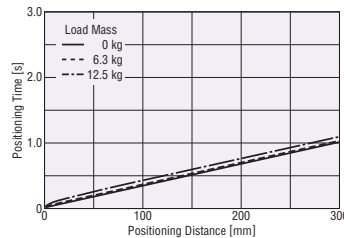

- Positioning Distance – Operating Speed

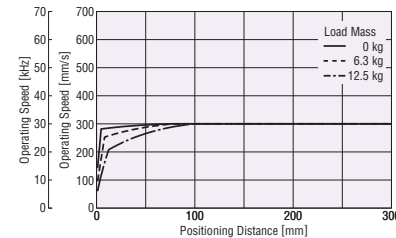

- Positioning Distance – Acceleration

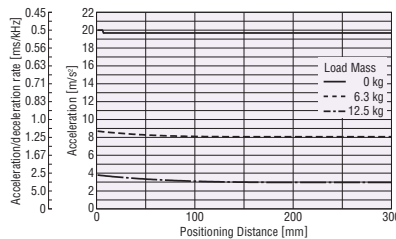

● The values for operating speed [kHz] and acceleration/deceleration rate [ms/kHz] in the above graphs apply when the minimum traveling amount for the electric cylinders is set to 0.01 mm.

Overview,
Product
Series

Electric
Linear
Slides

Q₁STEP
AZ/AR
EAS

Q₁STEP
AZ/AR
EZS

Electric
Cylinders

Q₁STEP
AZ/AR
EAC

Compact
Linear
Actuators

Q₁STEP
AZ
DRS2

DRLII

Installation

Hollow
Rotary
Actuators

Q₁STEP
AZ/AR
DGII

Accessories

α STEP
AZ
Equipped

α STEP
AR
Equipped

● **EAC4: Straight Type 24 VDC Input**
Lead Screw Pitch: 12 mm

◇ Horizontal Direction Installation

● Positioning Distance – Positioning Time

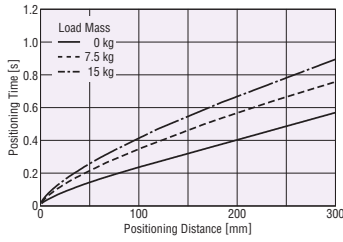

● Positioning Distance – Operating Speed

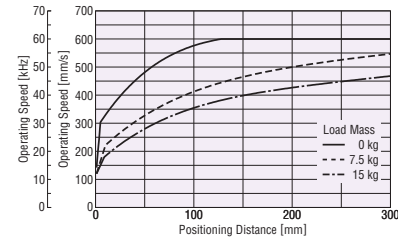

● Positioning Distance – Acceleration

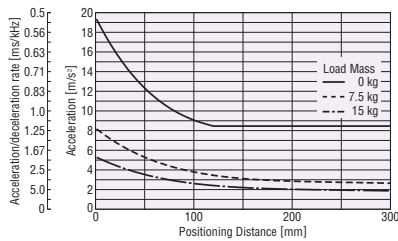

◇ Vertical Direction Installation

● Positioning Distance – Positioning Time

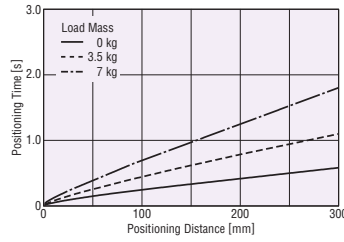

● Positioning Distance – Operating Speed

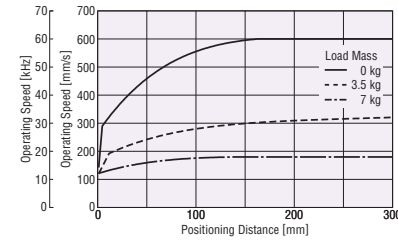

● Positioning Distance – Acceleration

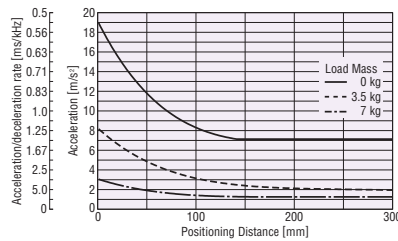

● **EAC4: Straight Type 24 VDC Input**
Lead Screw Pitch: 6 mm

◇ Horizontal Direction Installation

● Positioning Distance – Positioning Time

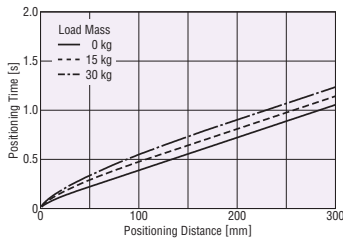

● Positioning Distance – Operating Speed

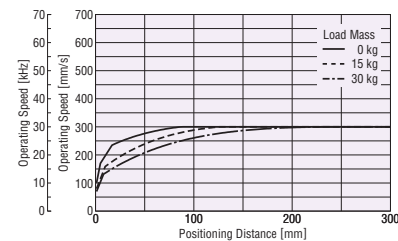

● Positioning Distance – Acceleration

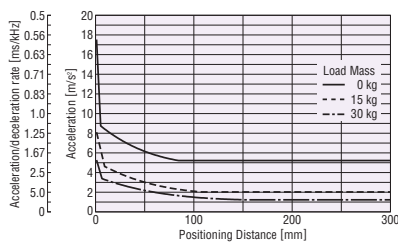

◇ Vertical Direction Installation

● Positioning Distance – Positioning Time

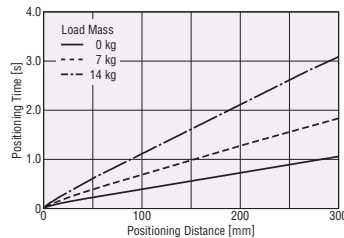

● Positioning Distance – Operating Speed

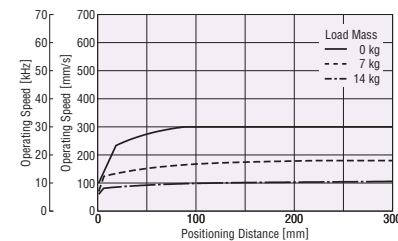

● Positioning Distance – Acceleration

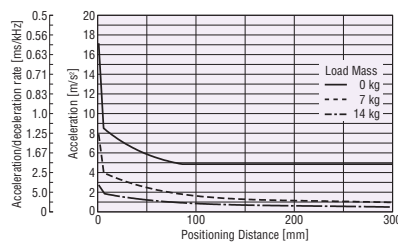

● The values for operating speed [kHz] and acceleration/deceleration rate [ms/kHz] in the above graphs apply when the minimum traveling amount for the electric cylinders is set to 0.01 mm.

● **EAC4: Reversed Motor Type 24 VDC Input**
Lead Screw Pitch: 12 mm

◇ Horizontal Direction Installation

● Positioning Distance – Positioning Time

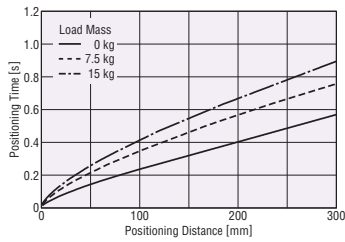

● Positioning Distance – Operating Speed

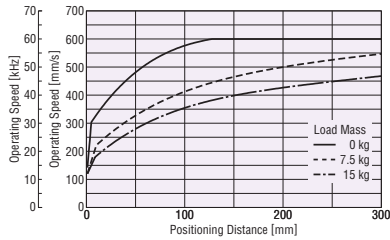

● Positioning Distance – Acceleration

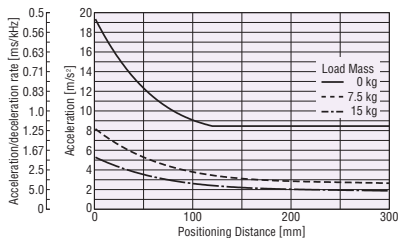

◇ Vertical Direction Installation

● Positioning Distance – Positioning Time

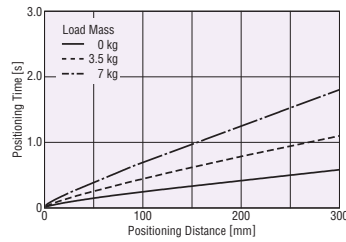

● Positioning Distance – Operating Speed

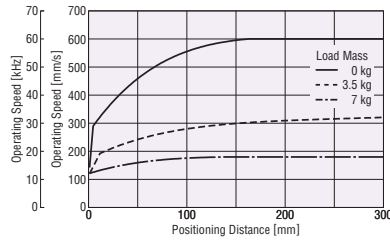

● Positioning Distance – Acceleration

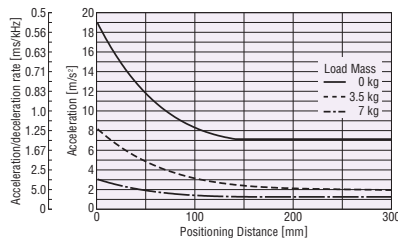

● **EAC4: Reversed Motor Type 24 VDC Input**
Lead Screw Pitch: 6 mm

◇ Horizontal Direction Installation

● Positioning Distance – Positioning Time

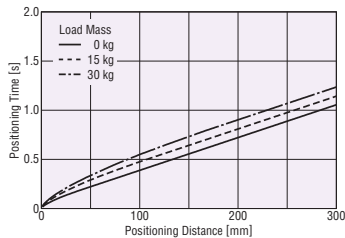

● Positioning Distance – Operating Speed

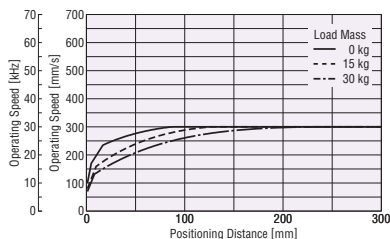

● Positioning Distance – Acceleration

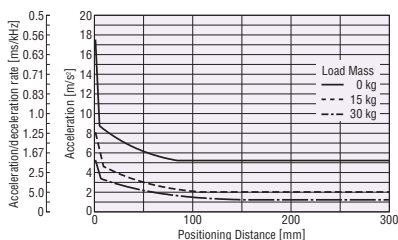

◇ Vertical Direction Installation

● Positioning Distance – Positioning Time

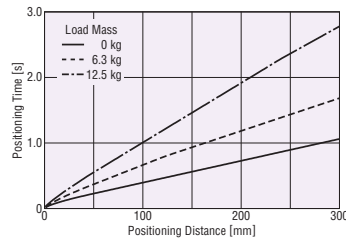

● Positioning Distance – Operating Speed

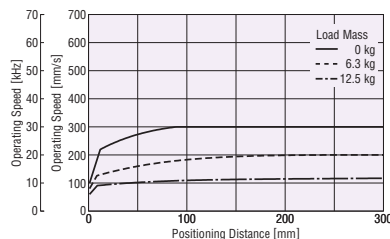

● Positioning Distance – Acceleration

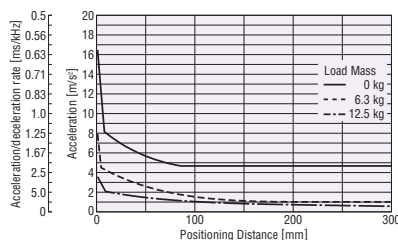

● The values for operating speed [kHz] and acceleration/deceleration rate [ms/kHz] in the above graphs apply when the minimum traveling amount for the electric cylinders is set to 0.01 mm.

Overview,
Product
Series

Electric
Linear
Slides

Q¹STEP
AZ/AR
EAS

Q¹STEP
AZ/AR
EZS

Electric
Cylinders

Q¹STEP
AZ/AR
EAC

Compact
Linear
Actuators

Q¹STEP
AZ
DRS2

DRLII

Installation

Hollow
Rotary
Actuators

Q¹STEP
AZ/AR
DGII

Accessories

α STEP
AZ
Equipped

α STEP
AR
Equipped

● **EAC6: Straight Type/Reversed Motor Type AC Input**
Lead Screw Pitch: 12 mm

◇ Horizontal Direction Installation

● Positioning Distance – Positioning Time

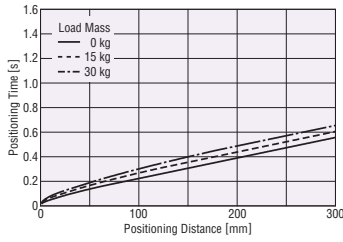

● Positioning Distance – Operating Speed

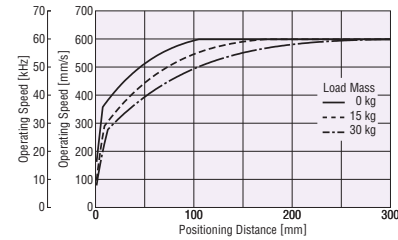

● Positioning Distance – Acceleration

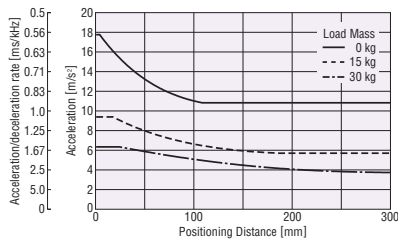

◇ Vertical Direction Installation

● Positioning Distance – Positioning Time

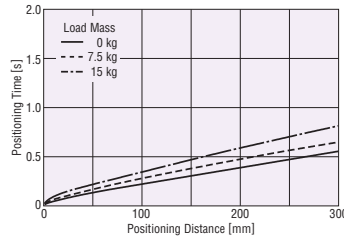

● Positioning Distance – Operating Speed

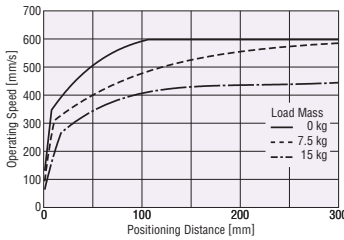

● Positioning Distance – Acceleration

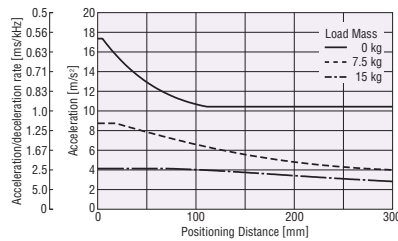

● **EAC6: Straight Type/Reversed Motor Type AC Input**
Lead Screw Pitch: 6 mm

◇ Horizontal Direction Installation

● Positioning Distance – Positioning Time

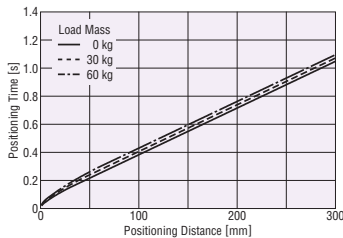

● Positioning Distance – Operating Speed

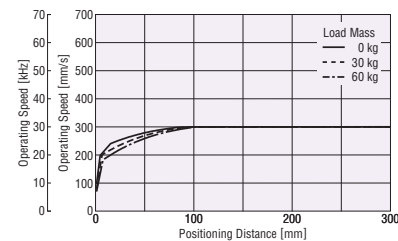

● Positioning Distance – Acceleration

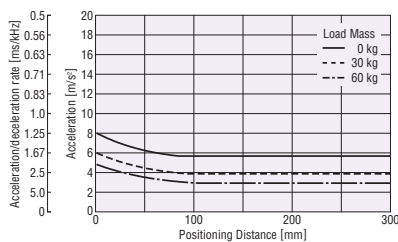

◇ Vertical Direction Installation

● Positioning Distance – Positioning Time

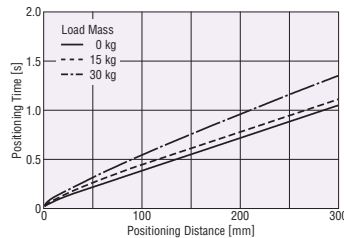

● Positioning Distance – Operating Speed

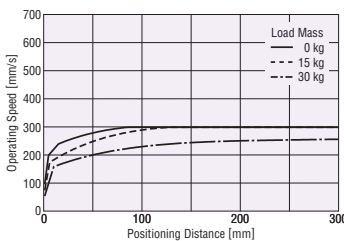

● Positioning Distance – Acceleration

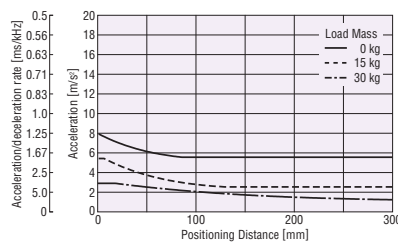

● The values for operating speed [kHz] and acceleration/deceleration rate [ms/kHz] in the above graphs apply when the minimum traveling amount for the electric cylinders is set to 0.01 mm.

● **EAC6: Straight Type/Reversed Motor Type 24 VDC Input**
Lead Screw Pitch: 12 mm

◇ Horizontal Direction Installation

● Positioning Distance – Positioning Time

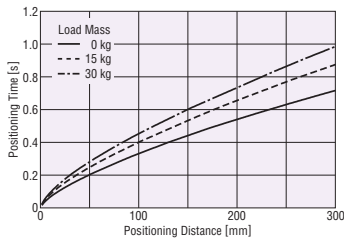

● Positioning Distance – Operating Speed

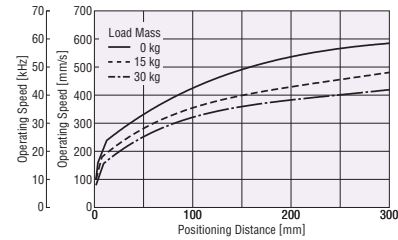

● Positioning Distance – Acceleration

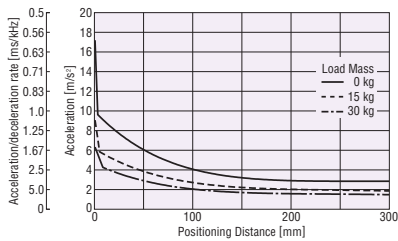

◇ Vertical Direction Installation

● Positioning Distance – Positioning Time

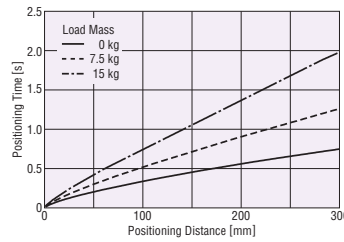

● Positioning Distance – Operating Speed

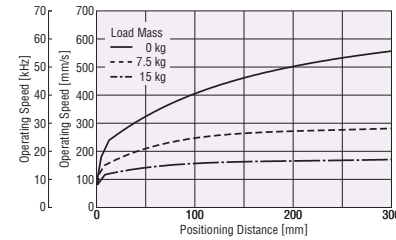

● Positioning Distance – Acceleration

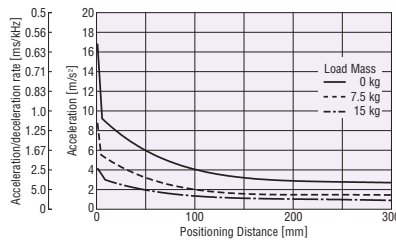

● **EAC6: Straight Type/Reversed Motor Type 24 VDC Input**
Lead Screw Pitch: 6 mm

◇ Horizontal Direction Installation

● Positioning Distance – Positioning Time

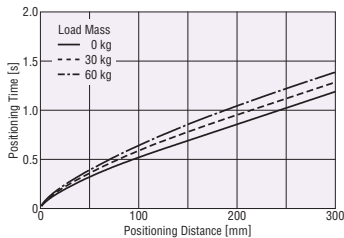

● Positioning Distance – Operating Speed

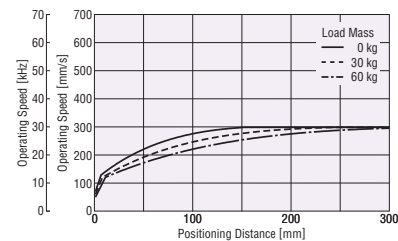

● Positioning Distance – Acceleration

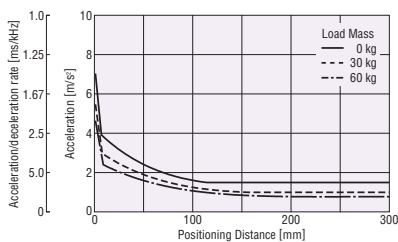

◇ Vertical Direction Installation

● Positioning Distance – Positioning Time

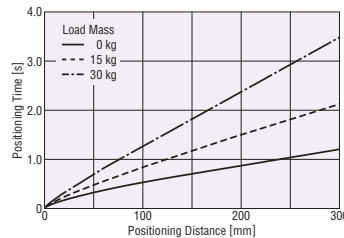

● Positioning Distance – Operating Speed

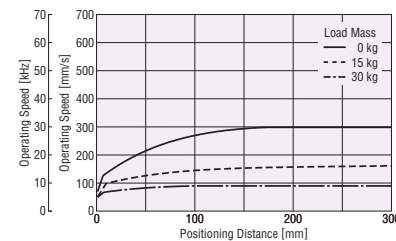

● Positioning Distance – Acceleration

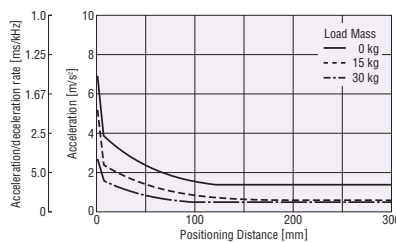

● The values for operating speed [kHz] and acceleration/deceleration rate [ms/kHz] in the above graphs apply when the minimum traveling amount for the electric cylinders is set to 0.01 mm.

Overview,
Product
Series

Electric
Linear
Slides

Q₁STEP
AZ/AR
EAS

Q₁STEP
AZ/AR
EZS

Electric
Cylinders

Q₁STEP
AZ/AR
EAC

Compact
Linear
Actuators

Q₁STEP
AZ
DRS2

DRLII

Installation

Hollow
Rotary
Actuators

Q₁STEP
AZ/AR
DGII

Accessories

α STEP
AZ
Equipped

α STEP
AR
Equipped

● **EAC4: Straight Type with Shaft Guide (with Cover) AC Input**
Lead Screw Pitch: 12 mm

◇ Horizontal Direction Installation

● Positioning Distance – Positioning Time

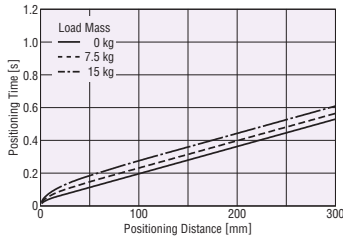

● Positioning Distance – Operating Speed

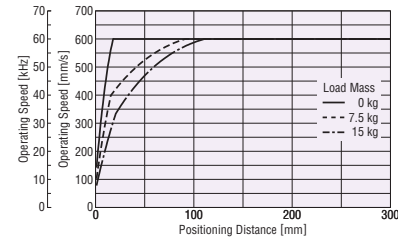

● Positioning Distance – Acceleration

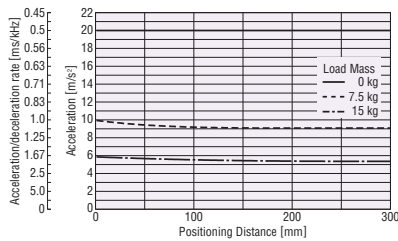

◇ Vertical Direction Installation

● Positioning Distance – Positioning Time

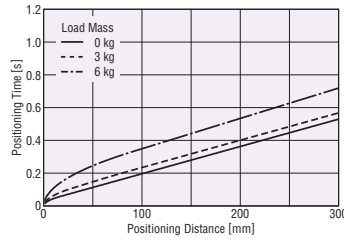

● Positioning Distance – Operating Speed

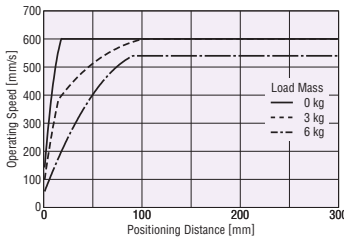

● Positioning Distance – Acceleration

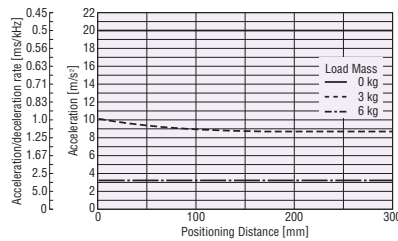

● **EAC4: Straight Type with Shaft Guide (with Cover) AC Input**
Lead Screw Pitch: 6 mm

◇ Horizontal Direction Installation

● Positioning Distance – Positioning Time

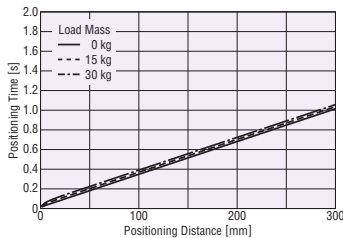

● Positioning Distance – Operating Speed

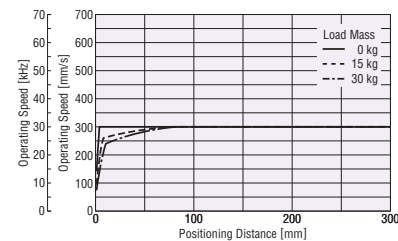

● Positioning Distance – Acceleration

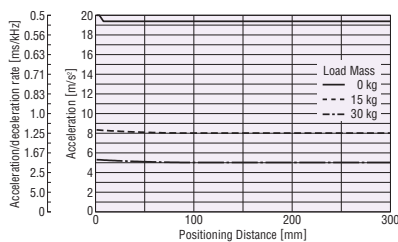

◇ Vertical Direction Installation

● Positioning Distance – Positioning Time

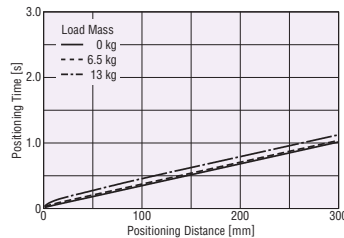

● Positioning Distance – Operating Speed

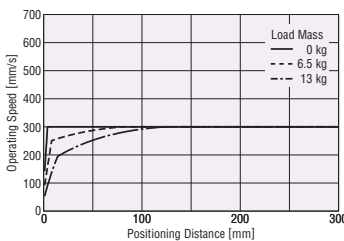

● Positioning Distance – Acceleration

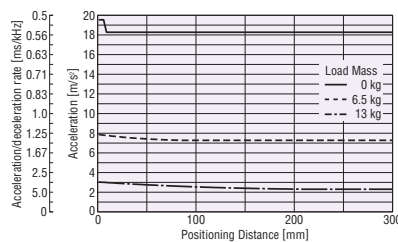

● The values for operating speed [kHz] and acceleration/deceleration rate [ms/kHz] in the above graphs apply when the minimum traveling amount for the electric cylinders is set to 0.01 mm.

● **EAC4: Reversed Motor Type with Shaft Guide (with Cover) AC Input**
Lead Screw Pitch: 12 mm

◇ Horizontal Direction Installation

● Positioning Distance – Positioning Time

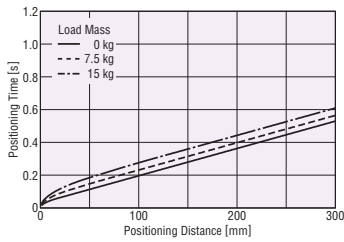

● Positioning Distance – Operating Speed

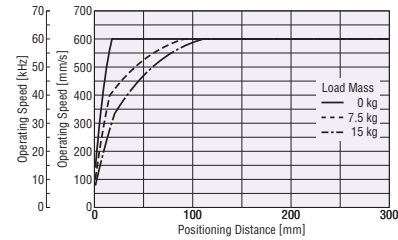

● Positioning Distance – Acceleration

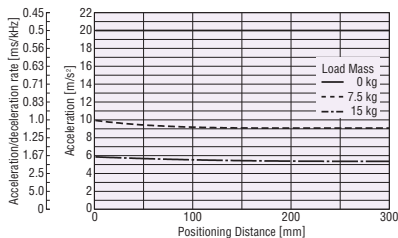

◇ Vertical Direction Installation

● Positioning Distance – Positioning Time

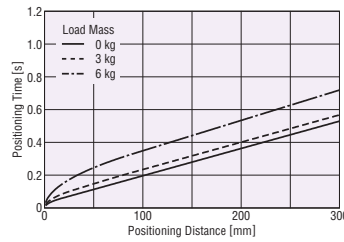

● Positioning Distance – Operating Speed

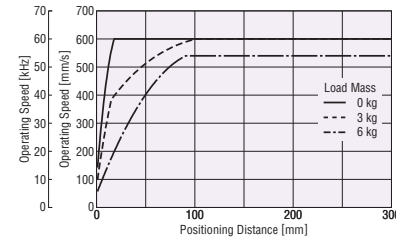

● Positioning Distance – Acceleration

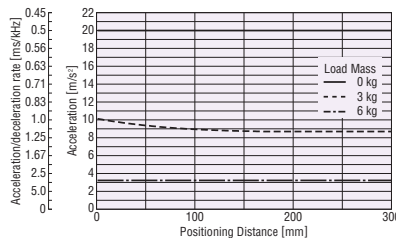

● **EAC4: Reversed Motor Type with Shaft Guide (with Cover) AC Input**
Lead Screw Pitch: 6 mm

◇ Horizontal Direction Installation

● Positioning Distance – Positioning Time

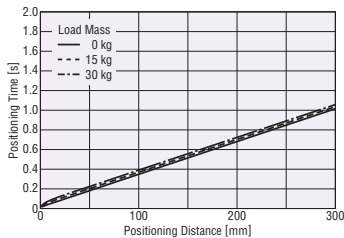

● Positioning Distance – Operating Speed

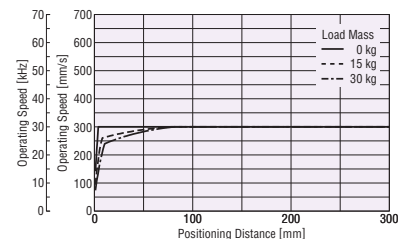

● Positioning Distance – Acceleration

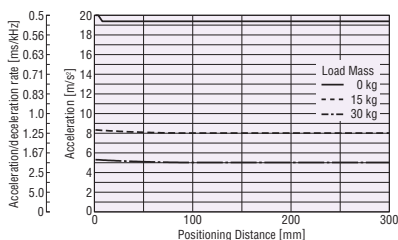

◇ Vertical Direction Installation

● Positioning Distance – Positioning Time

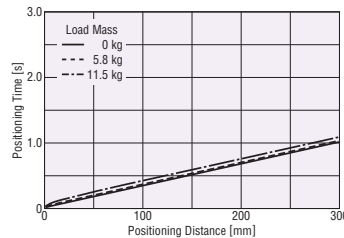

● Positioning Distance – Operating Speed

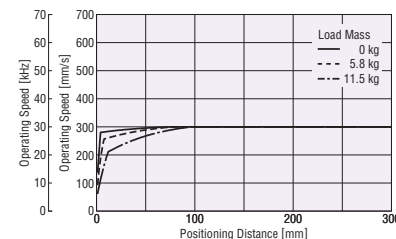

● Positioning Distance – Acceleration

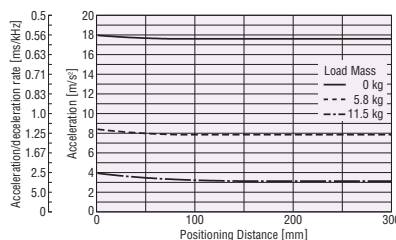

● The values for operating speed [kHz] and acceleration/deceleration rate [ms/kHz] in the above graphs apply when the minimum traveling amount for the electric cylinders is set to 0.01 mm.

Overview,
Product
Series

Electric
Linear
Slides

Q₁STEP
AZ/AR
EAS

Q₁STEP
AZ/AR
EZS

Electric
Cylinders

Q₁STEP
AZ/AR
EAC

Compact
Linear
Actuators

Q₁STEP
AZ
DRS2

DRLII

Installation

Hollow
Rotary
Actuators

Q₁STEP
AZ/AR
DGII

Accessories

α STEP
AZ
Equipped

α STEP
AR
Equipped

● **EAC4: Straight Type with Shaft Guide (with Cover) 24 VDC Input**
Lead Screw Pitch: 12 mm

◇ Horizontal Direction Installation

● Positioning Distance – Positioning Time

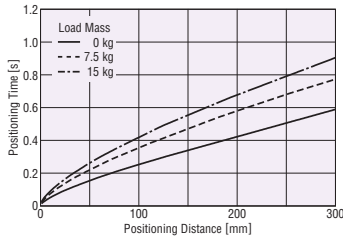

● Positioning Distance – Operating Speed

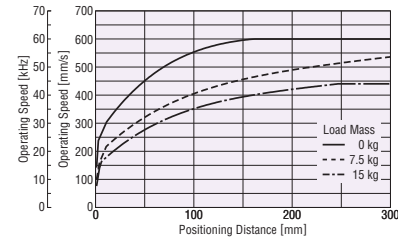

● Positioning Distance – Acceleration

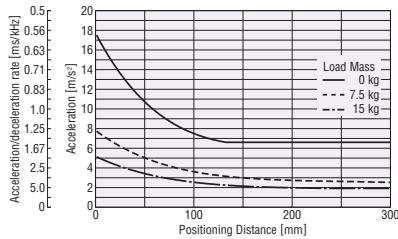

◇ Vertical Direction Installation

● Positioning Distance – Positioning Time

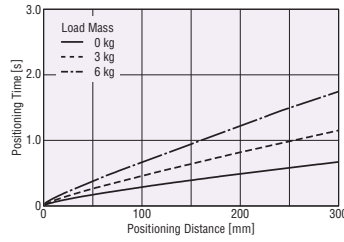

● Positioning Distance – Operating Speed

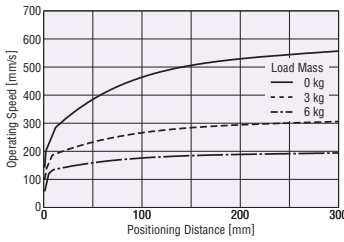

● Positioning Distance – Acceleration

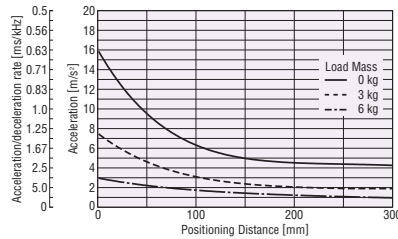

● **EAC4: Straight Type with Shaft Guide (with Cover) 24 VDC Input**
Lead Screw Pitch: 6 mm

◇ Horizontal Direction Installation

● Positioning Distance – Positioning Time

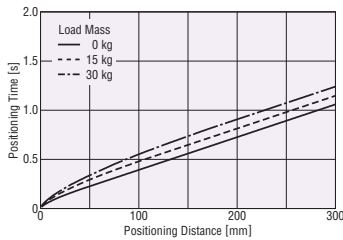

● Positioning Distance – Operating Speed

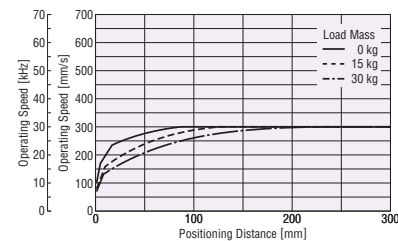

● Positioning Distance – Acceleration

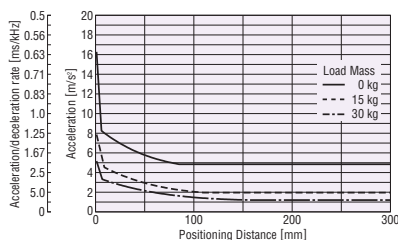

◇ Vertical Direction Installation

● Positioning Distance – Positioning Time

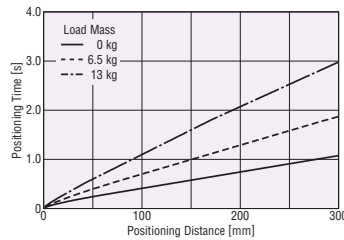

● Positioning Distance – Operating Speed

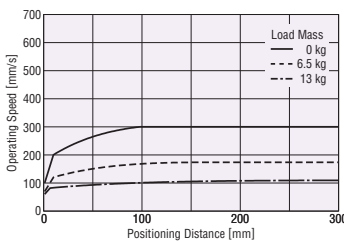

● Positioning Distance – Acceleration

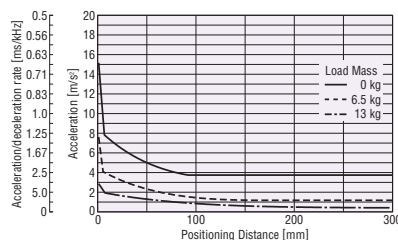

● The values for operating speed [kHz] and acceleration/deceleration rate [ms/kHz] in the above graphs apply when the minimum traveling amount for the electric cylinders is set to 0.01 mm.

● **EAC4: Reversed Motor Type with Shaft Guide (with Cover) 24 VDC Input**
 Lead Screw Pitch: 12 mm

◇ Horizontal Direction Installation

● Positioning Distance – Positioning Time

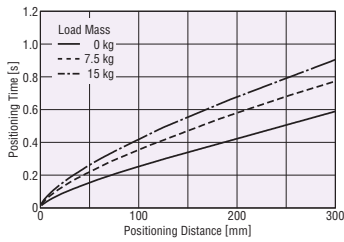

● Positioning Distance – Operating Speed

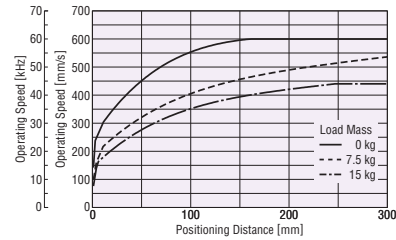

● Positioning Distance – Acceleration

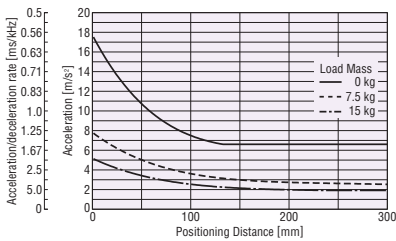

◇ Vertical Direction Installation

● Positioning Distance – Positioning Time

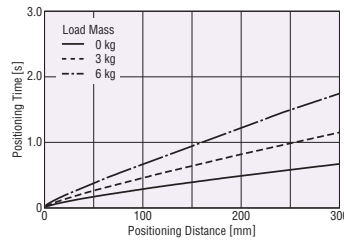

● Positioning Distance – Operating Speed

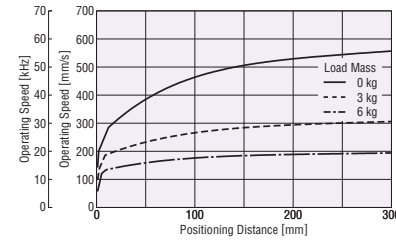

● Positioning Distance – Acceleration

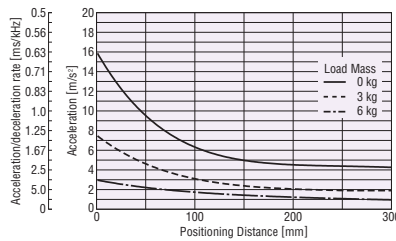

● **EAC4: Reversed Motor Type with Shaft Guide (with Cover) 24 VDC Input**
 Lead Screw Pitch: 6 mm

◇ Horizontal Direction Installation

● Positioning Distance – Positioning Time

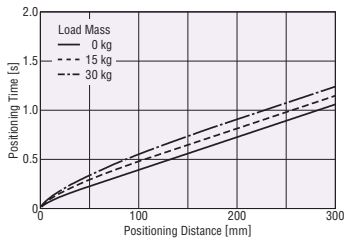

● Positioning Distance – Operating Speed

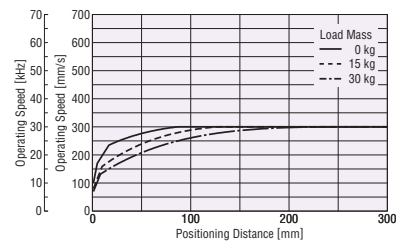

● Positioning Distance – Acceleration

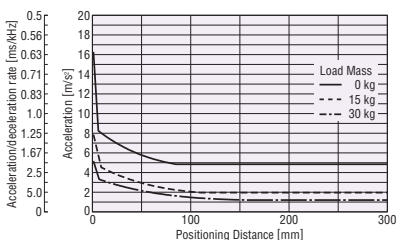

◇ Vertical Direction Installation

● Positioning Distance – Positioning Time

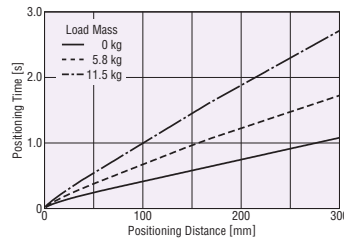

● Positioning Distance – Operating Speed

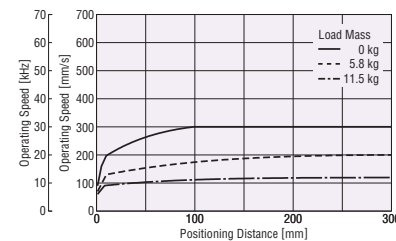

● Positioning Distance – Acceleration

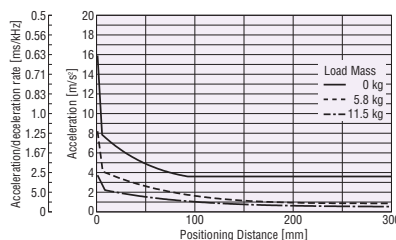

● The values for operating speed [kHz] and acceleration/deceleration rate [ms/kHz] in the above graphs apply when the minimum traveling amount for the electric cylinders is set to 0.01 mm.

Overview,
Product
Series

Electric
Linear
Slides

Q₁STEP
AZ/AR
EAS

Q₁STEP
AZ/AR
EZS

Electric
Cylinders

Q₁STEP
AZ/AR
EAC

Compact
Linear
Actuators

Q₁STEP
AZ
DRS2

DRLII

Installation

Hollow
Rotary
Actuators

Q₁STEP
AZ/AR
DGII

Accessories

α STEP
AZ
Equipped

α STEP
AR
Equipped

● **EAC6: Straight Type/Reversed Motor Type with Shaft Guide (with Cover) AC Input**
Lead Screw Pitch: 12 mm

◇ Horizontal Direction Installation

● Positioning Distance – Positioning Time

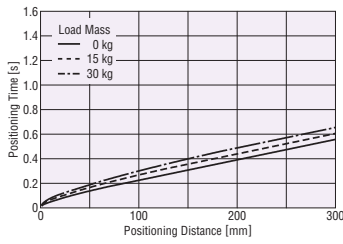

● Positioning Distance – Operating Speed

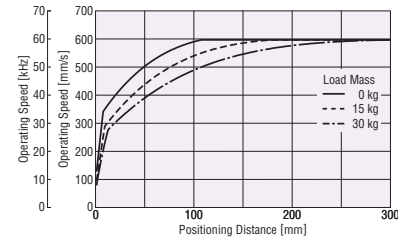

● Positioning Distance – Acceleration

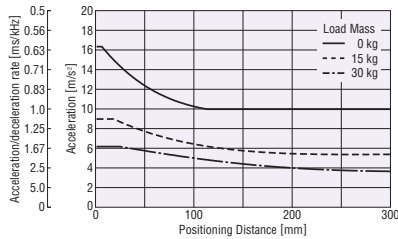

◇ Vertical Direction Installation

● Positioning Distance – Positioning Time

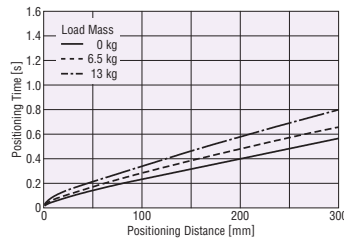

● Positioning Distance – Operating Speed

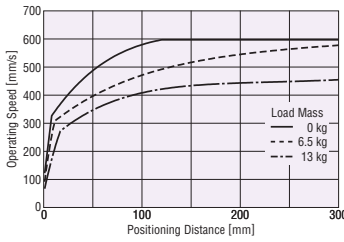

● Positioning Distance – Acceleration

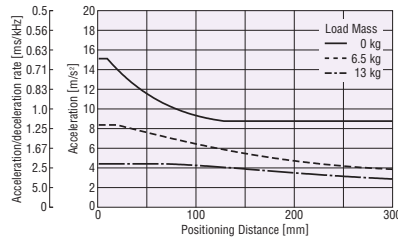

● **EAC6: Straight Type/Reversed Motor Type with Shaft Guide (with Cover) AC Input**
Lead Screw Pitch: 6 mm

◇ Horizontal Direction Installation

● Positioning Distance – Positioning Time

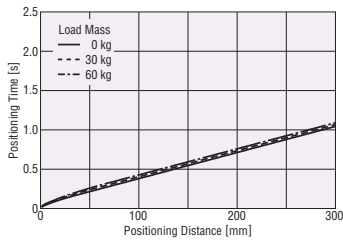

● Positioning Distance – Operating Speed

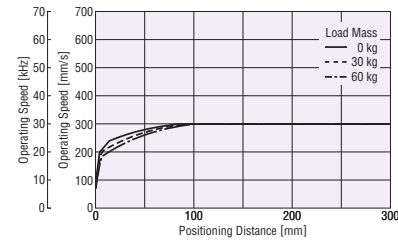

● Positioning Distance – Acceleration

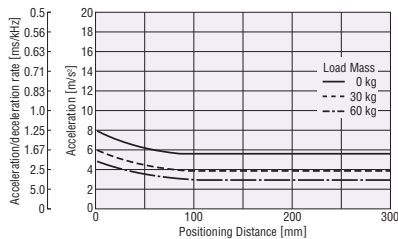

◇ Vertical Direction Installation

● Positioning Distance – Positioning Time

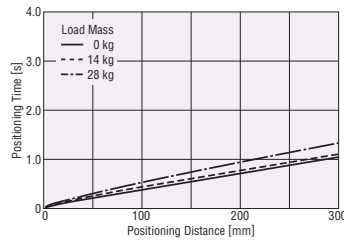

● Positioning Distance – Operating Speed

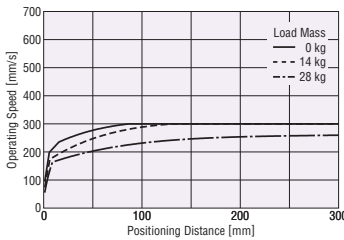

● Positioning Distance – Acceleration

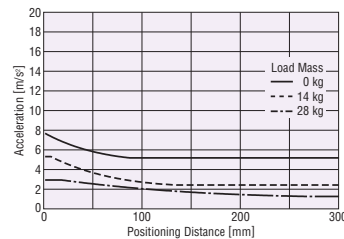

● The values for operating speed [kHz] and acceleration/deceleration rate [ms/kHz] in the above graphs apply when the minimum traveling amount for the electric cylinders is set to 0.01 mm.

● **EAC6:** Straight Type/Reversed Motor Type with Shaft Guide (with Cover) 24 VDC Input
Lead Screw Pitch: 12 mm

◇ Horizontal Direction Installation

● Positioning Distance – Positioning Time

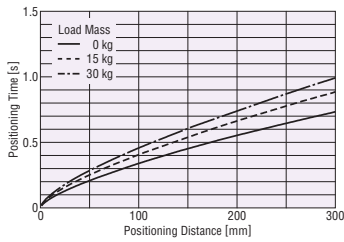

● Positioning Distance – Operating Speed

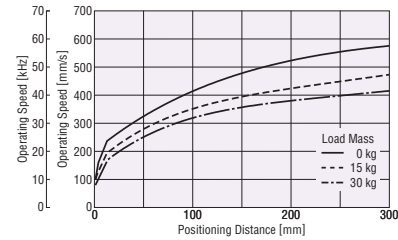

● Positioning Distance – Acceleration

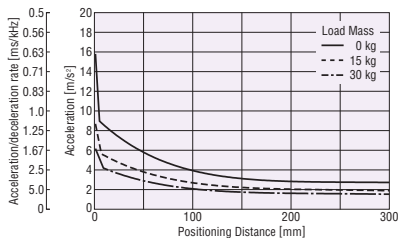

◇ Vertical Direction Installation

● Positioning Distance – Positioning Time

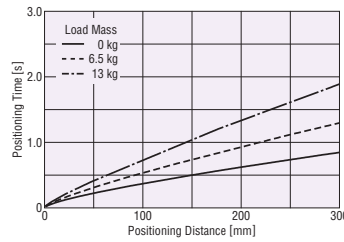

● Positioning Distance – Operating Speed

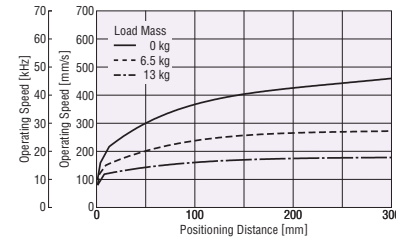

● Positioning Distance – Acceleration

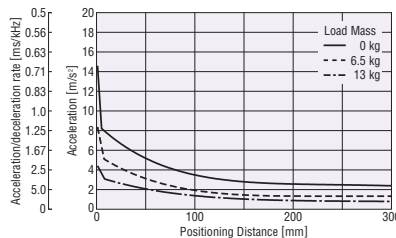

● **EAC6:** Straight Type/Reversed Motor Type with Shaft Guide (with Cover) 24 VDC Input
Lead Screw Pitch: 6 mm

◇ Horizontal Direction Installation

● Positioning Distance – Positioning Time

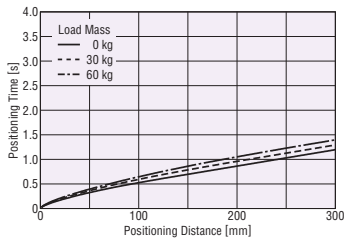

● Positioning Distance – Operating Speed

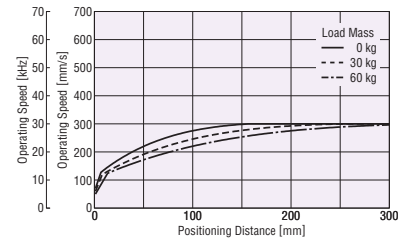

● Positioning Distance – Acceleration

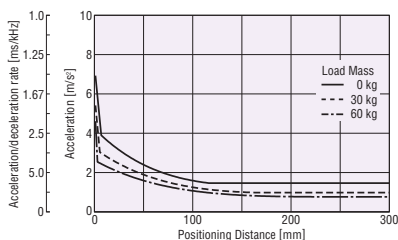

◇ Vertical Direction Installation

● Positioning Distance – Positioning Time

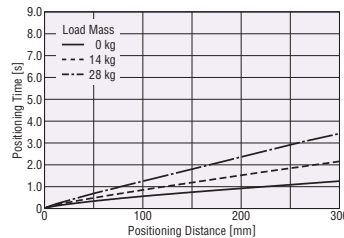

● Positioning Distance – Operating Speed

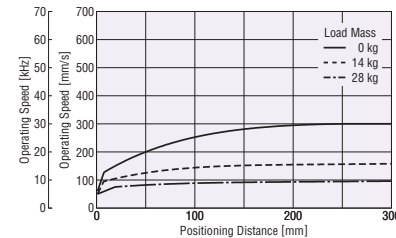

● Positioning Distance – Acceleration

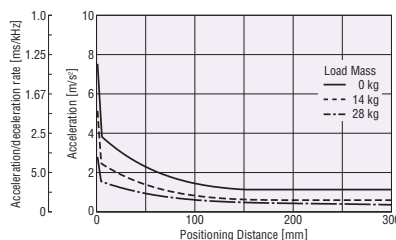

● The values for operating speed [kHz] and acceleration/deceleration rate [ms/kHz] in the above graphs apply when the minimum traveling amount for the electric cylinders is set to 0.01 mm.

Overview,
Product
Series

Electric
Linear
Slides

Q₁STEP
AZ/AR
EAS

Q₁STEP
AZ/AR
EZS

Electric
Cylinders

Q₁STEP
AZ/AR
EAC

Compact
Linear
Actuators

Q₁STEP
AZ
DRS2

DRLII

Installation

Hollow
Rotary
Actuators

Q₁STEP
AZ/AR
DGII

Accessories

About Use of the EAC6 (AC Input Type) for Vertical Driving

When operating **EAC6** type in the vertical direction, depending on the operating conditions, the overvoltage protective function may be activated under the influence of regenerative power and the alarm may be output.

Refer to the operating speed – load mass characteristics diagram below, and connect the **RGB100** regeneration unit accessory (sold separately) to the driver.

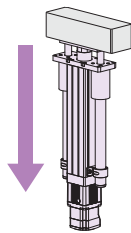

α STEP
AZ
Equipped

α STEP
AR
Equipped

Region in Which the EAC6 Generation Unit RGB100 is Necessary

◇ Type without a Shaft Guide

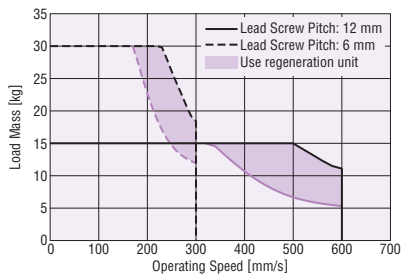

◇ Type with a Shaft Guide (with a cover)

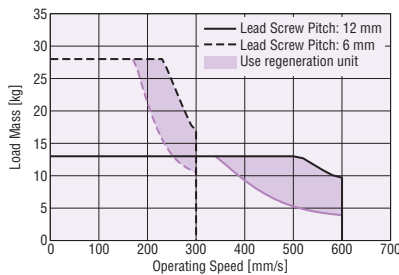

● Regeneration Unit

When a regeneration unit is attached to the special terminal on the driver, the regenerative power that is fed back from the motor is released as heat energy.



◇ Product Line

Product Name	Applicable Products	List Price
RGB100	AC Input Type	€41.00

◇ Specifications

Item	Specifications
Continuous Regenerative Power	50 W
Resistance Value	150 Ω
Thermostat Operating Temperature	Open: $150 \pm 7^\circ\text{C}$ Close: $145 \pm 12^\circ\text{C}$ (Normally closed)
Thermostat Electrical Rating	120 VAC 4 A 30 VDC 4 A (Minimum current 5 mA)

● Install the regeneration unit in the place which has the same heat radiation capability as heat radiation plate [Material: Aluminum 350 mm \times 350 mm, 3 mm thick].

List of Electric Cylinders and Driver Combinations

The product names for electric cylinders and driver combinations are shown below. The parentheses () in the product names of the electric cylinder parts indicate the product name of the equipped motor. If you are purchasing the equipped motor for maintenance purposes, please contact the nearest Oriental Motor sales office.

● AC Input

◇ Built-in Controller Type Single Shaft

Product Name	Electric Cylinders Part Product Name (Equipped Motor Part Product Name)	Driver Product Name
EAC4 ②- E ⑤- AZACD -⑩	EACM4②E⑤AZAC (AZM46AC)	AZD-CD
EAC4 ②- D ⑤- AZACD -⑩	EACM4②D⑤AZAC (AZM46AC)	
EAC4 ②- W-E ⑤- AZACD -⑩	EACM4②WE⑤AZAC (AZM46AC)	
EAC4 ②- W-D ⑤- AZACD -⑩	EACM4②WD⑤AZAC (AZM46AC)	
EAC4 ②- W-E ⑤- AZACD -⑩- G	EACM4②WE⑤AZAC-G (AZM46AC)	
EAC4 ②- W-D ⑤- AZACD -⑩- G	EACM4②WD⑤AZAC-G (AZM46AC)	
EAC6 ②- E ⑤- AZACD -⑩	EACM6②E⑤AZAC (AZM66AC)	
EAC6 ②- D ⑤- AZACD -⑩	EACM6②D⑤AZAC (AZM66AC)	
EAC6 ②- W-E ⑤- AZACD -⑩	EACM6②WE⑤AZAC (AZM66AC)	
EAC6 ②- W-D ⑤- AZACD -⑩	EACM6②WD⑤AZAC (AZM66AC)	
EAC6 ②- W-E ⑤- AZACD -⑩- G	EACM6②WE⑤AZAC-G (AZM66AC)	
EAC6 ②- W-D ⑤- AZACD -⑩- G	EACM6②WD⑤AZAC-G (AZM66AC)	

◇ Pulse Input Type Single Shaft

Product Name	Electric Cylinders Part Product Name (Equipped Motor Part Product Name)	Driver Product Name
EAC4 ②- E ⑤- AZAC -⑩	EACM4②E⑤AZAC (AZM46AC)	AZD-C
EAC4 ②- D ⑤- AZAC -⑩	EACM4②D⑤AZAC (AZM46AC)	
EAC4 ②- W-E ⑤- AZAC -⑩	EACM4②WE⑤AZAC (AZM46AC)	
EAC4 ②- W-D ⑤- AZAC -⑩	EACM4②WD⑤AZAC (AZM46AC)	
EAC4 ②- W-E ⑤- AZAC -⑩- G	EACM4②WE⑤AZAC-G (AZM46AC)	
EAC4 ②- W-D ⑤- AZAC -⑩- G	EACM4②WD⑤AZAC-G (AZM46AC)	
EAC6 ②- E ⑤- AZAC -⑩	EACM6②E⑤AZAC (AZM66AC)	
EAC6 ②- D ⑤- AZAC -⑩	EACM6②D⑤AZAC (AZM66AC)	
EAC6 ②- W-E ⑤- AZAC -⑩	EACM6②WE⑤AZAC (AZM66AC)	
EAC6 ②- W-D ⑤- AZAC -⑩	EACM6②WD⑤AZAC (AZM66AC)	
EAC4 ②- W-E ⑤- AZAC -⑩- G	EACM6②WE⑤AZAC-G (AZM66AC)	
EAC6 ②- W-D ⑤- AZAC -⑩- G	EACM6②WD⑤AZAC-G (AZM66AC)	

● DC Input

◇ Built-in Controller Type Single Shaft

Product Name	Electric Cylinders Part Product Name (Equipped Motor Part Product Name)	Driver Product Name
EAC2 - E ⑤- AZAKD -⑩	EACM2E⑤AZAK (AZM24K)	AZD-KD
EAC2 - F ⑤- AZAKD -⑩	EACM2F⑤AZAK (AZM24K)	
EAC2 - W-E ⑤- AZAKD -⑩- G	EACM2WE⑤AZAK-G (AZM24K)	
EAC2 - W-F ⑤- AZAKD -⑩- G	EACM2WF⑤AZAK-G (AZM24K)	
EAC4 ②- E ⑤- AZAKD -⑩	EACM4②E⑤AZAK (AZM46AK)	
EAC4 ②- D ⑤- AZAKD -⑩	EACM4②D⑤AZAK (AZM46AK)	
EAC4 ②- W-E ⑤- AZAKD -⑩	EACM4②WE⑤AZAK (AZM46AK)	
EAC4 ②- W-D ⑤- AZAKD -⑩	EACM4②WD⑤AZAK (AZM46AK)	
EAC4 ②- W-E ⑤- AZAKD -⑩- G	EACM4②WE⑤AZAK-G (AZM46AK)	
EAC4 ②- W-D ⑤- AZAKD -⑩- G	EACM4②WD⑤AZAK-G (AZM46AK)	
EAC6 ②- E ⑤- AZAKD -⑩	EACM6②E⑤AZAK (AZM66AK)	
EAC6 ②- D ⑤- AZAKD -⑩	EACM6②D⑤AZAK (AZM66AK)	
EAC6 ②- W-E ⑤- AZAKD -⑩	EACM6②WE⑤AZAK (AZM66AK)	
EAC6 ②- W-D ⑤- AZAKD -⑩	EACM6②WD⑤AZAK (AZM66AK)	
EAC6 ②- W-E ⑤- AZAKD -⑩- G	EACM6②WE⑤AZAK-G (AZM66AK)	
EAC6 ②- W-D ⑤- AZAKD -⑩- G	EACM6②WD⑤AZAK-G (AZM66AK)	

◇ Pulse Input Type Single Shaft

Product Name	Electric Cylinders Part Product Name (Equipped Motor Part Product Name)	Driver Product Name
EAC2 - E ⑤- AZAK -⑩	EACM2E⑤AZAK (AZM24K)	AZD-K
EAC2 - F ⑤- AZAK -⑩	EACM2F⑤AZAK (AZM24K)	
EAC2 - W-E ⑤- AZAK -⑩- G	EACM2WE⑤AZAK-G (AZM24K)	
EAC2 - W-F ⑤- AZAK -⑩- G	EACM2WF⑤AZAK-G (AZM24K)	
EAC4 ②- E ⑤- AZAK -⑩	EACM4②E⑤AZAK (AZM46AK)	
EAC4 ②- D ⑤- AZAK -⑩	EACM4②D⑤AZAK (AZM46AK)	
EAC4 ②- W-E ⑤- AZAK -⑩	EACM4②WE⑤AZAK (AZM46AK)	
EAC4 ②- W-D ⑤- AZAK -⑩	EACM4②WD⑤AZAK (AZM46AK)	
EAC4 ②- W-E ⑤- AZAK -⑩- G	EACM4②WE⑤AZAK-G (AZM46AK)	
EAC4 ②- W-D ⑤- AZAK -⑩- G	EACM4②WD⑤AZAK-G (AZM46AK)	
EAC6 ②- E ⑤- AZAK -⑩	EACM6②E⑤AZAK (AZM66AK)	
EAC6 ②- D ⑤- AZAK -⑩	EACM6②D⑤AZAK (AZM66AK)	
EAC6 ②- W-E ⑤- AZAK -⑩	EACM6②WE⑤AZAK (AZM66AK)	
EAC6 ②- W-D ⑤- AZAK -⑩	EACM6②WD⑤AZAK (AZM66AK)	
EAC6 ②- W-E ⑤- AZAK -⑩- G	EACM6②WE⑤AZAK-G (AZM66AK)	
EAC6 ②- W-D ⑤- AZAK -⑩- G	EACM6②WD⑤AZAK-G (AZM66AK)	

● A symbol or number shown below is specified where ②⑤⑩ are located in the product name.

②: R (reversed motor) indicating the motor installation direction is specified here. No letter is entered for the straight type.

⑤: A number indicating the stroke length is located.

⑩: For products that includes a connection cable, a number indicating the cable length, 1 (1 m), 2 (2 m), 3 (3 m) is located. If no connection cable is included, there will be no ⑩.

◇ Built-in Controller Type With Electromagnetic Brake

Product Name	Electric Cylinders Part Product Name (Equipped Motor Part Product Name)	Driver Product Name
EAC4 ②- E ⑤- AZMCD -⑩	EACM4②E⑤AZMC (AZM46MC)	AZD-CD
EAC4 ②- D ⑤- AZMCD -⑩	EACM4②D⑤AZMC (AZM46MC)	
EAC4 ②- W-E ⑤- AZMCD -⑩	EACM4②WE⑤AZMC (AZM46MC)	
EAC4 ②- W-D ⑤- AZMCD -⑩	EACM4②WD⑤AZMC (AZM46MC)	
EAC4 ②- W-E ⑤- AZMCD -⑩- G	EACM4②WE⑤AZMC-G (AZM46MC)	
EAC4 ②- W-D ⑤- AZMCD -⑩- G	EACM4②WD⑤AZMC-G (AZM46MC)	
EAC6 ②- E ⑤- AZMCD -⑩	EACM6②E⑤AZMC (AZM66MC)	
EAC6 ②- D ⑤- AZMCD -⑩	EACM6②D⑤AZMC (AZM66MC)	
EAC6 ②- W-E ⑤- AZMCD -⑩	EACM6②WE⑤AZMC (AZM66MC)	
EAC6 ②- W-D ⑤- AZMCD -⑩	EACM6②WD⑤AZMC (AZM66MC)	
EAC6 ②- W-E ⑤- AZMCD -⑩- G	EACM6②WE⑤AZMC-G (AZM66MC)	
EAC6 ②- W-D ⑤- AZMCD -⑩- G	EACM6②WD⑤AZMC-G (AZM66MC)	

◇ Pulse Input Type With Electromagnetic Brake

Product Name	Electric Cylinders Part Product Name (Equipped Motor Part Product Name)	Driver Product Name
EAC4 ②- E ⑤- AZMC -⑩	EACM4②E⑤AZMC (AZM46MC)	AZD-C
EAC4 ②- D ⑤- AZMC -⑩	EACM4②D⑤AZMC (AZM46MC)	
EAC4 ②- W-E ⑤- AZMC -⑩	EACM4②WE⑤AZMC (AZM46MC)	
EAC4 ②- W-D ⑤- AZMC -⑩	EACM4②WD⑤AZMC (AZM46MC)	
EAC4 ②- W-E ⑤- AZMC -⑩- G	EACM4②WE⑤AZMC-G (AZM46MC)	
EAC4 ②- W-D ⑤- AZMC -⑩- G	EACM4②WD⑤AZMC-G (AZM46MC)	
EAC6 ②- E ⑤- AZMC -⑩	EACM6②E⑤AZMC (AZM66MC)	
EAC6 ②- D ⑤- AZMC -⑩	EACM6②D⑤AZMC (AZM66MC)	
EAC6 ②- W-E ⑤- AZMC -⑩	EACM6②WE⑤AZMC (AZM66MC)	
EAC6 ②- W-D ⑤- AZMC -⑩	EACM6②WD⑤AZMC (AZM66MC)	
EAC6 ②- W-E ⑤- AZMC -⑩- G	EACM6②WE⑤AZMC-G (AZM66MC)	
EAC6 ②- W-D ⑤- AZMC -⑩- G	EACM6②WD⑤AZMC-G (AZM66MC)	

◇ Built-in Controller Type With Electromagnetic Brake

Product Name	Electric Cylinders Part Product Name (Equipped Motor Part Product Name)	Driver Product Name
EAC4 ②- E ⑤- AZMKD -⑩	EACM4②E⑤AZMK (AZM46MK)	AZD-KD
EAC4 ②- D ⑤- AZMKD -⑩	EACM4②D⑤AZMK (AZM46MK)	
EAC4 ②- W-E ⑤- AZMKD -⑩	EACM4②WE⑤AZMK (AZM46MK)	
EAC4 ②- W-D ⑤- AZMKD -⑩	EACM4②WD⑤AZMK (AZM46MK)	
EAC4 ②- W-E ⑤- AZMKD -⑩- G	EACM4②WE⑤AZMK-G (AZM46MK)	
EAC4 ②- W-D ⑤- AZMKD -⑩- G	EACM4②WD⑤AZMK-G (AZM46MK)	
EAC6 ②- E ⑤- AZMKD -⑩	EACM6②E⑤AZMK (AZM66MK)	
EAC6 ②- D ⑤- AZMKD -⑩	EACM6②D⑤AZMK (AZM66MK)	
EAC6 ②- W-E ⑤- AZMKD -⑩	EACM6②WE⑤AZMK (AZM66MK)	
EAC6 ②- W-D ⑤- AZMKD -⑩	EACM6②WD⑤AZMK (AZM66MK)	
EAC6 ②- W-E ⑤- AZMKD -⑩- G	EACM6②WE⑤AZMK-G (AZM66MK)	
EAC6 ②- W-D ⑤- AZMKD -⑩- G	EACM6②WD⑤AZMK-G (AZM66MK)	

◇ Pulse Input Type With Electromagnetic Brake

Product Name	Electric Cylinders Part Product Name (Equipped Motor Part Product Name)	Driver Product Name
EAC4 ②- E ⑤- AZMK -⑩	EACM4②E⑤AZMK (AZM46MK)	AZD-K
EAC4 ②- D ⑤- AZMK -⑩	EACM4②D⑤AZMK (AZM46MK)	
EAC4 ②- W-E ⑤- AZMK -⑩	EACM4②WE⑤AZMK (AZM46MK)	
EAC4 ②- W-D ⑤- AZMK -⑩	EACM4②WD⑤AZMK (AZM46MK)	
EAC4 ②- W-E ⑤- AZMK -⑩- G	EACM4②WE⑤AZMK-G (AZM46MK)	
EAC4 ②- W-D ⑤- AZMK -⑩- G	EACM4②WD⑤AZMK-G (AZM46MK)	
EAC6 ②- E ⑤- AZMK -⑩	EACM6②E⑤AZMK (AZM66MK)	
EAC6 ②- D ⑤- AZMK -⑩	EACM6②D⑤AZMK (AZM66MK)	
EAC6 ②- W-E ⑤- AZMK -⑩	EACM6②WE⑤AZMK (AZM66MK)	
EAC6 ②- W-D ⑤- AZMK -⑩	EACM6②WD⑤AZMK (AZM66MK)	
EAC6 ②- W-E ⑤- AZMK -⑩- G	EACM6②WE⑤AZMK-G (AZM66MK)	
EAC6 ②- W-D ⑤- AZMK -⑩- G	EACM6②WD⑤AZMK-G (AZM66MK)	

Overview, Product Series

Electric Linear Slides

Q-STEP AZ/AR EAS

Q-STEP AZ/AR EZS

Electric Cylinders

Q-STEP AZ/AR EAC

Compact Linear Actuators

Q-STEP AZ DRS2

DRLII

Installation

Hollow Rotary Actuators

Q-STEP AZ/AR DGII

Accessories